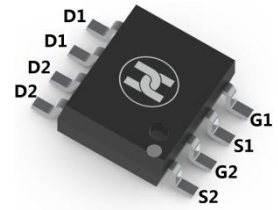
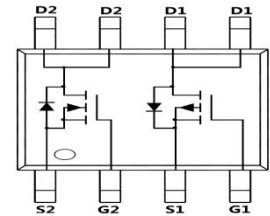

COMPLEMENTARY MOSFET
FEATURES

- $V_{DS}=30V, I_D=6A, R_{DS(ON)} \leq 30m\Omega @ V_{GS}=10V$
- $V_{DS}=-30V, I_D=-6.5A, R_{DS(ON)} \leq 28m\Omega @ V_{GS}=-10V$
- Low gate charge and Ultra low on-resistance
- For level shifted high side switch and for a host of other applications.
- Surface Mount device

MECHANICAL DATA

- Case: SOP-8
- Case Material: Molded Plastic. UL flammability
- Classification Rating: 94V-0
- Moisture Sensitivity: Level 1 per J-STD-020
- Weight: 0.3 grams (approximate)

SOP-8

MAXIMUM RATINGS ($T_A = 25^\circ\text{C}$ unless otherwise noted)

Parameter	Symbol	Max N-channel	Max P-channel	Unit	
Drain-source voltage	V_{DS}	30	-30	V	
Gate-source voltage	V_{GS}	± 20	± 20	V	
Continuous drain current	I_D	$T_A = 25^\circ\text{C}$	6	-6.5	A
		$T_A = 70^\circ\text{C}$	5	-5.3	A
Pulsed drain current	I_{DM}	30	-30	A	
Avalanche current	I_{AS}, I_{AR}	10	23	A	
Avalanche energy $L=0.1\text{mH}$	E_{AS}, E_{AR}	5	26	mJ	
Power dissipation	P_D	$T_A = 25^\circ\text{C}$	2	2	W
		$T_A = 70^\circ\text{C}$	1.3	1.3	W
Thermal resistance from Junction to ambient	$R_{\theta JA}$	74		$^\circ\text{C/W}$	
Thermal resistance from Junction to Lead	$R_{\theta JL}$	32		$^\circ\text{C/W}$	
Junction temperature	T_J	150		$^\circ\text{C}$	
Storage temperature	T_{STG}	-55 ~ +150		$^\circ\text{C}$	

N-CHANNEL ELECTRICAL CHARACTERISTICS ($T_A = 25^\circ\text{C}$ unless otherwise specified)

Parameter	Symbol	Min	Typ	Max	Unit	Conditions
Drain-Source breakdown voltage	$V_{(BR)DSS}^*$	30			V	$V_{GS}=0V, I_D=250\mu A$
Zero gate voltage drain current	I_{DSS}^*			1	μA	$V_{DS}=30V, V_{GS}=0V$
Gate-body leakage current	I_{GSS}^*			± 100	μA	$V_{DS}=0V, V_{GS}=\pm 20V$
Gate-threshold voltage	$V_{GS(th)}^*$	1.2	1.8	2.4	V	$V_{DS}=V_{GS}, I_D=250\mu A$
On-State Drain Current	$I_{D(ON)}$	30			A	$V_{DS}=5V, V_{GS}=10V$
Drain-source on-resistance	$R_{DS(ON)}^*$		25	30	$m\Omega$	$V_{GS}=10V, I_D=6A$
			40	48	$m\Omega$	$V_{GS}=10V, I_D=6A, T_J=125^\circ\text{C}$
			33.5	42	$m\Omega$	$V_{GS}=4.5V, I_D=5A$
Forward transconductance	g_{FS}		15		S	$V_{DS}=5V, I_D=6A$
Diode forward voltage	V_{SD}		0.76	1	V	$I_S=1A, V_{GS}=0V$
Diode forward current	I_S			2.5	A	
Input capacitance	C_{iss}		255	310	pF	$V_{DS}=15V, V_{GS}=0V, f=1\text{MHz}$
Output capacitance	C_{oss}		45	60	pF	
Reverse transfer capacitance	C_{rss}		35	50	pF	
Gate resistance	R_g		3.25	4.9	Ω	$V_{DS}=0V, V_{GS}=0V, f=1\text{MHz}$
Total gate charge	Q_g		2.55	3	nC	$V_{GS}=4.5V, V_{DS}=15V, I_D=6A$
Total gate charge			5.2	6	nC	$V_{GS}=10V, V_{DS}=15V, I_D=6A$
Gate-source charge	Q_{gs}		0.85		nC	
Gate-drain charge	Q_{gd}		1.3		nC	
Turn-on delay time	$t_{d(on)}$		4.5		nS	$V_{GS}=10V, V_{DS}=15V, R_{GEN}=3\Omega, R_L=2.5\Omega$
Turn-on rise time	t_r		2.5		nS	
Turn-off delay time	$t_{d(off)}$		14.5		nS	
Turn-off fall time	t_f		3.5		nS	
Body Diode Reverse Recovery Time	t_{rr}		8.5	12	nS	
Body Diode Reverse Recovery Charge	Q_{rr}		2.2	3	nC	$I_F=6A, di/dt=100A/\mu S$

*Pulse test ; Pulse width $\leq 300\mu s$, Duty cycle $\leq 0.5\%$.

COMPLEMENTARY MOSFET

N-Channel: TYPICAL ELECTRICAL AND THERMAL CHARACTERISTICS

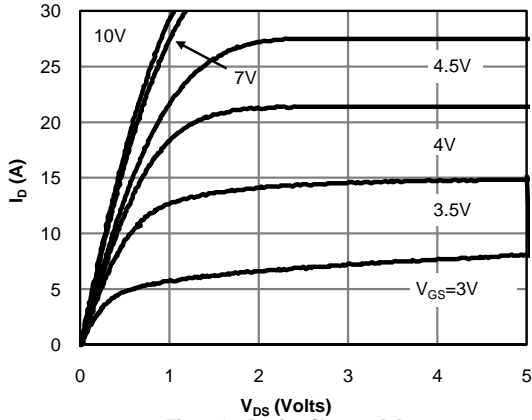

Fig 1: On-Region Characteristics

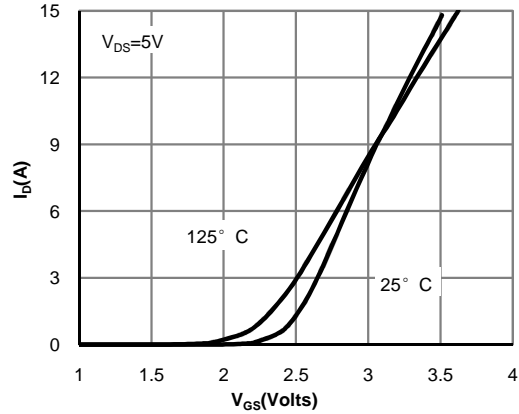

Figure 2: Transfer Characteristics

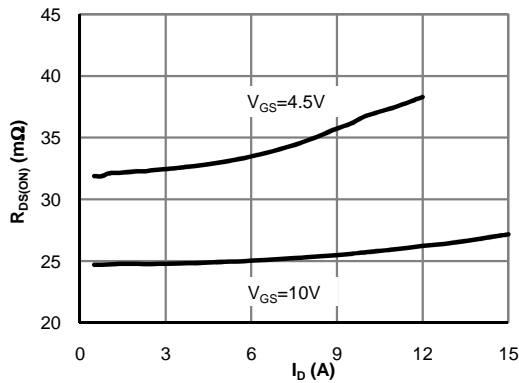

Figure 3: On-Resistance vs. Drain Current and Gate Voltage

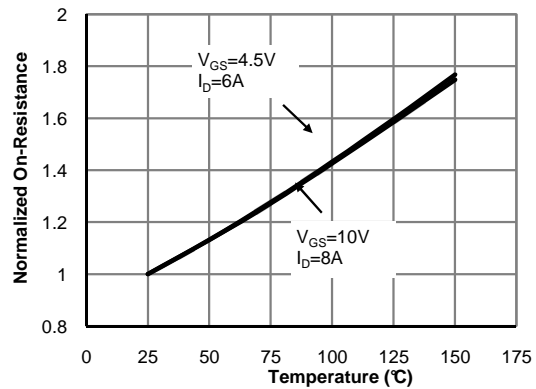

Figure 4: On-Resistance vs. Junction Temperature

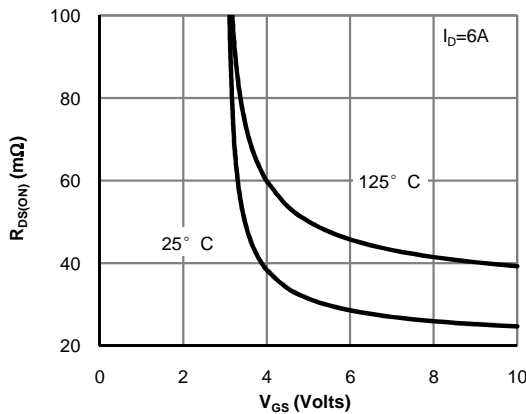

Figure 5: On-Resistance vs. Gate-Source Voltage

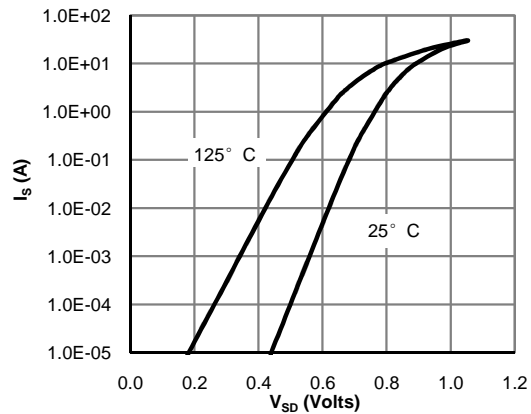

Figure 6: Body-Diode Characteristics

COMPLEMENTARY MOSFET

N-Channel: TYPICAL ELECTRICAL AND THERMAL CHARACTERISTICS

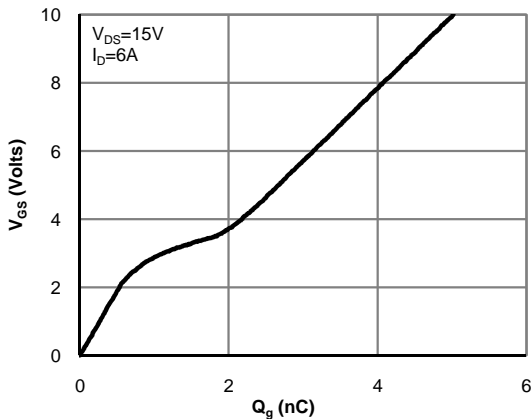

Figure 7: Gate-Charge Characteristics

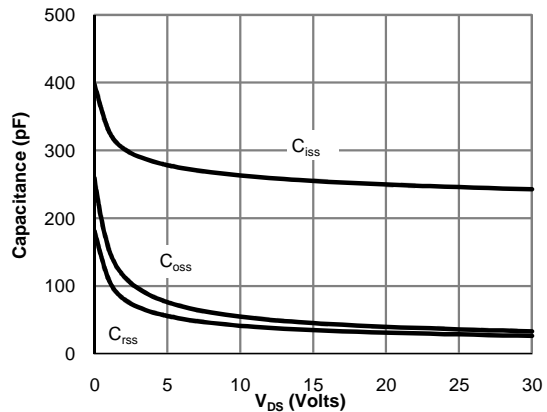

Figure 8: Capacitance Characteristics

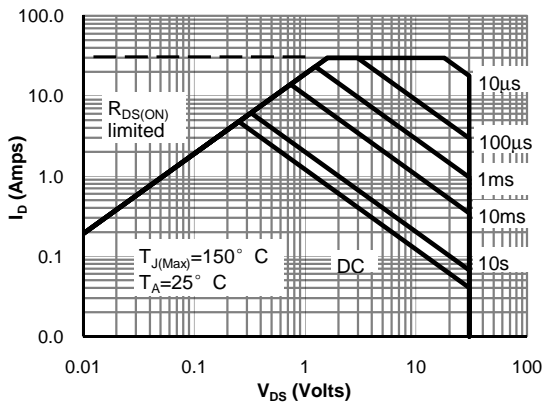

Figure 9: Maximum Forward Biased Safe Operating Area

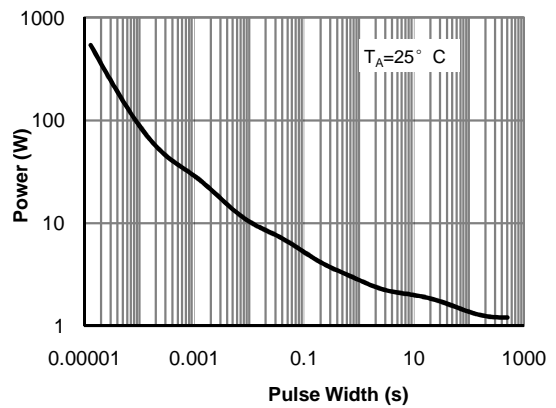

Figure 10: Single Pulse Power Rating Junction-to-Ambient

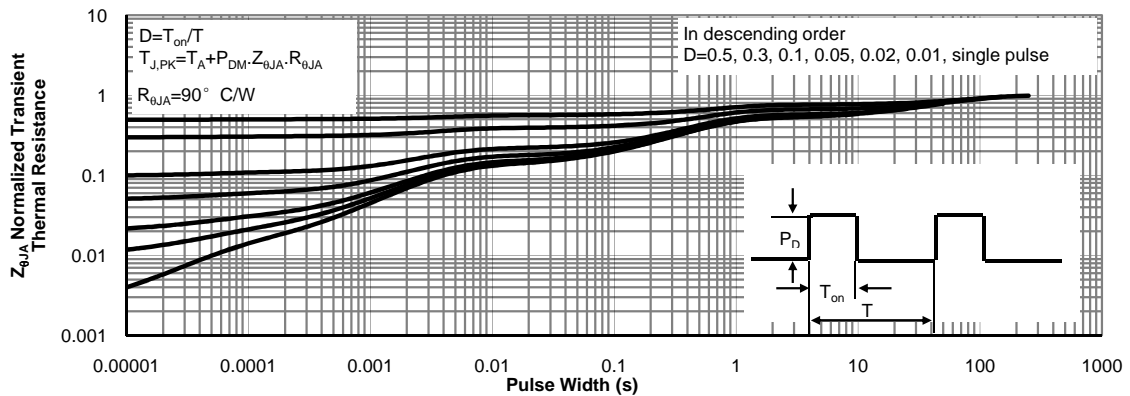
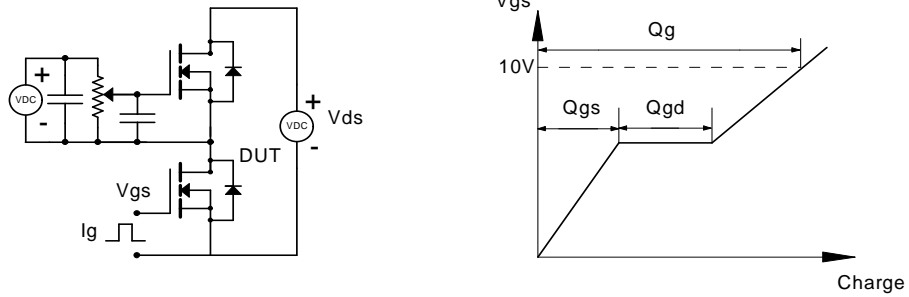

Figure 11: Normalized Maximum Transient Thermal Impedance

COMPLEMENTARY MOSFET

Gate Charge Test Circuit & Waveform



Resistive Switching Test Circuit & Waveforms

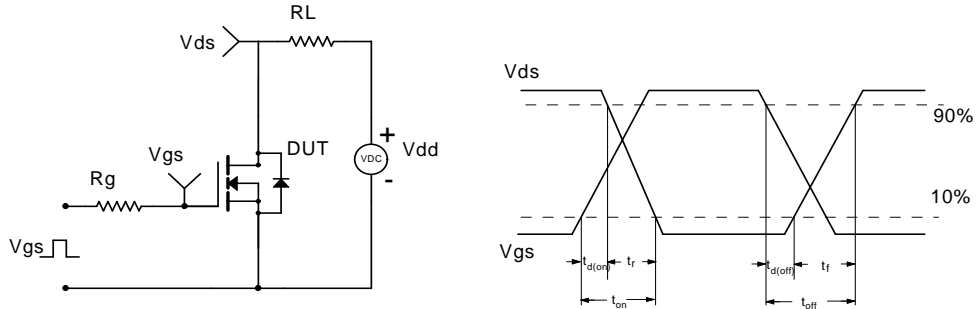

Unclamped Inductive Switching (UIS) Test Circuit & Waveforms

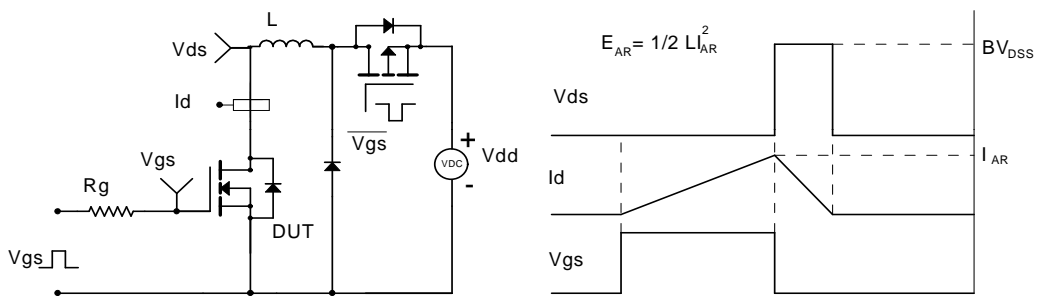

Diode Recovery Test Circuit & Waveforms

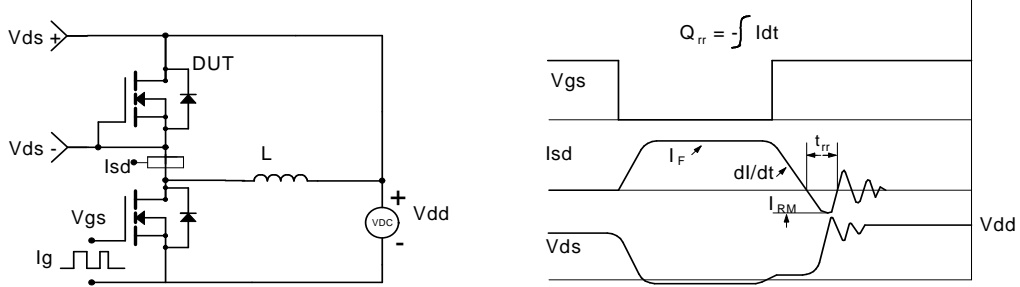

COMPLEMENTARY MOSFET
P-CHANNEL ELECTRICAL CHARACTERISTICS (T_A = 25°C unless otherwise specified)

Parameter	Symbol	Min	Typ	Max	Unit	Conditions
Drain-Source breakdown voltage	V _{(BR)DSS} *	-30			V	V _{GS} =0V, I _D =-250μA
Zero gate voltage drain current	I _{DSS} *			-1	μA	V _{DS} =-30V, V _{GS} =0V
Gate-body leakage current	I _{GSS} *			±100	nA	V _{DS} =0V, V _{GS} =±20V
Gate-threshold voltage	V _{GS(th)} *	-1.3	-1.85	-2.4	V	V _{DS} =V _{GS} , I _D =-250μA
On-State Drain Current	I _{D(ON)} *	-30			A	V _{DS} =-5V, V _{GS} =-10V
Drain-source on-resistance	R _{DS(ON)} *		22	28	mΩ	V _{GS} =-10V, I _D =-6.5A
			32	40	mΩ	V _{GS} =-10V, I _D =-6.5A, T _J =125°C
			34	44	mΩ	V _{GS} =-4.5V, I _D =-5A
Forward transconductance	g _{FS}		18		S	V _{DS} =-5V, I _D =-6.5A
Diode forward voltage	V _{SD}		-0.80	-1	V	I _S =-1A, V _{GS} =0V
Diode forward current	I _S			-2.5	A	
Input capacitance	C _{iss}		760		pF	V _{DS} =-15V, V _{GS} =0V, f=1MHz
Output capacitance	C _{oss}		140		pF	
Reverse transfer capacitance	C _{rss}		95		pF	
Gate resistance	R _g	1.5	3.2	5	Ω	V _{DS} =0V, V _{GS} =0V, f=1MHz
Total gate charge	Q _g		6.7	8	nC	V _{GS} =-4.5V, V _{DS} =-15V, I _D =-6.5A
Total gate charge			13.6	16	nC	
Gate-source charge	Q _{gs}		2.5		nC	V _{GS} =-10V, V _{DS} =-15V, I _D =-6.5A
Gate-drain charge	Q _{gd}		3.2		nC	
Turn-on delay time	t _{d(on)}		8		nS	V _{GS} =-10V, V _{DS} =-15V, R _{GEN} =3Ω, R _L =2.3Ω
Turn-on rise time	t _r		6		nS	
Turn-off delay time	t _{d(off)}		17		nS	
Turn-off fall time	t _f		5		nS	
Body Diode Reverse Recovery Time	t _{rr}		15		nS	I _F =-6.5A, dI/dt=100A/μs
Body Diode Reverse Recovery Charge	Q _{rr}		9.7		nC	I _F =-6.5A, dI/dt=100A/μs

*Pulse test ; Pulse width ≤300μs, Duty cycle ≤ 0.5% .

COMPLEMENTARY MOSFET

P-Channel: TYPICAL ELECTRICAL AND THERMAL CHARACTERISTICS

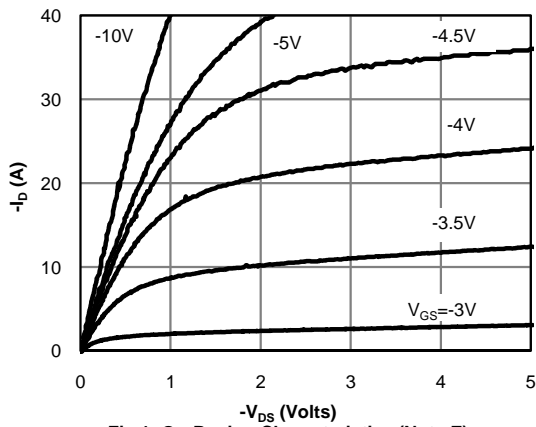

Fig 1: On-Region Characteristics (Note E)

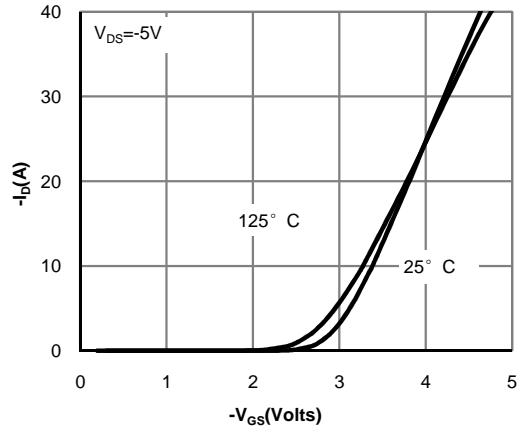

Figure 2: Transfer Characteristics (Note E)

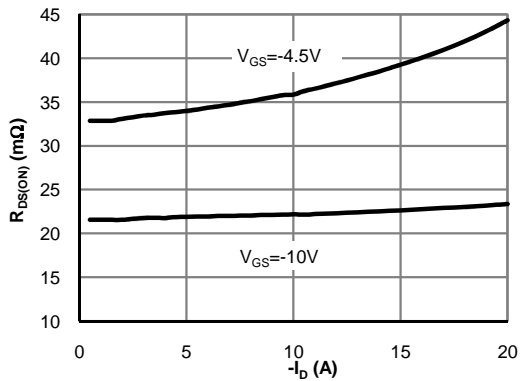

Figure 3: On-Resistance vs. Drain Current and Gate Voltage

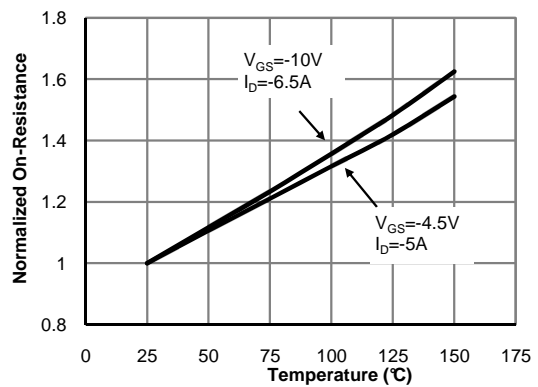

Figure 4: On-Resistance vs. Junction Temperature

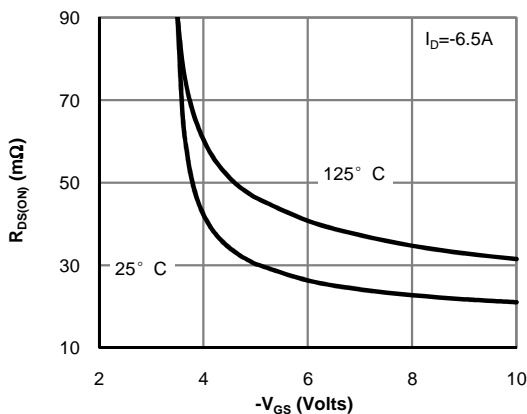

Figure 5: On-Resistance vs. Gate-Source Voltage

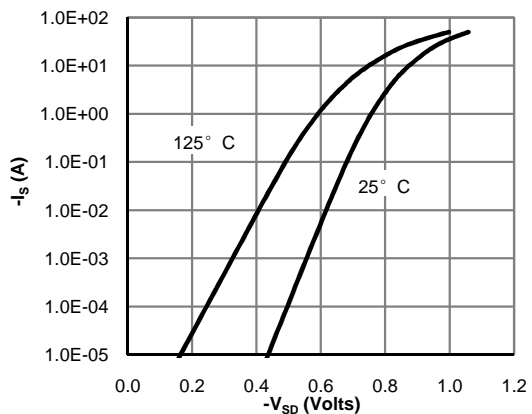

Figure 6: Body-Diode Characteristics

COMPLEMENTARY MOSFET

P-Channel: TYPICAL ELECTRICAL AND THERMAL CHARACTERISTICS

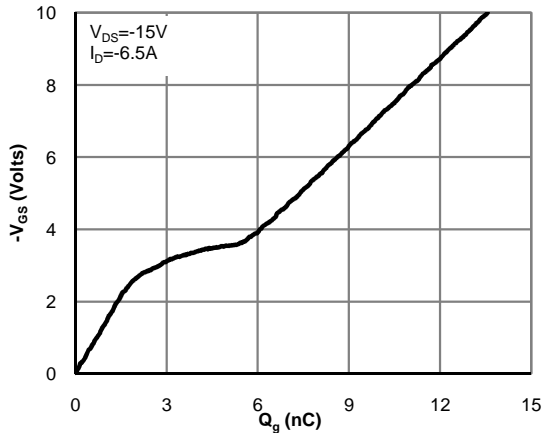

Figure 7: Gate-Charge Characteristics

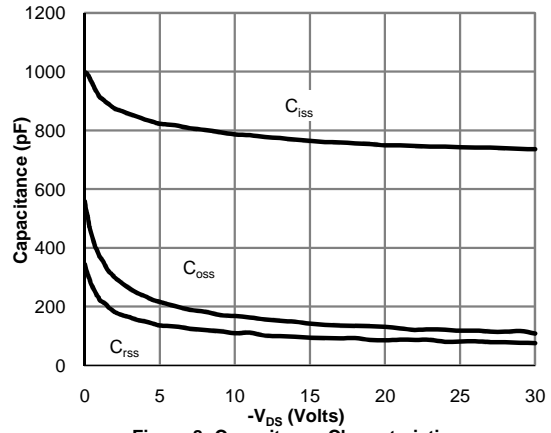

Figure 8: Capacitance Characteristics

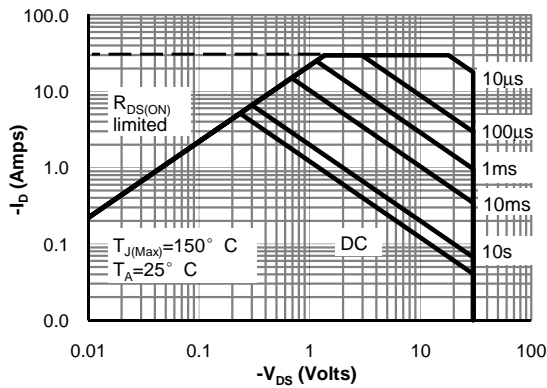

Figure 9: Maximum Forward Biased Safe Operating Area

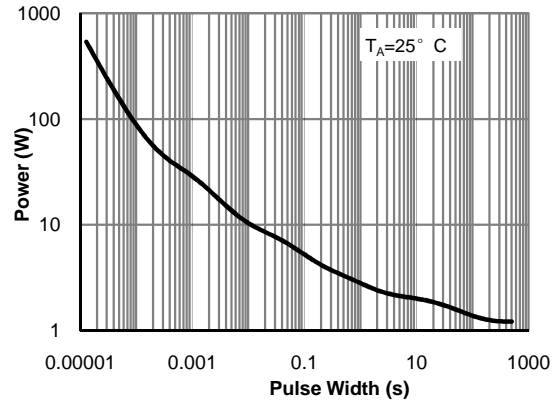

Figure 10: Single Pulse Power Rating Junction-to-Ambient

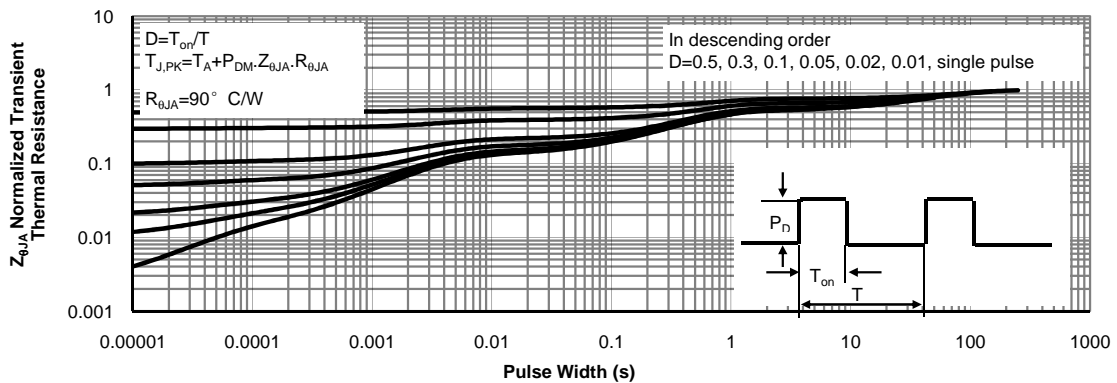
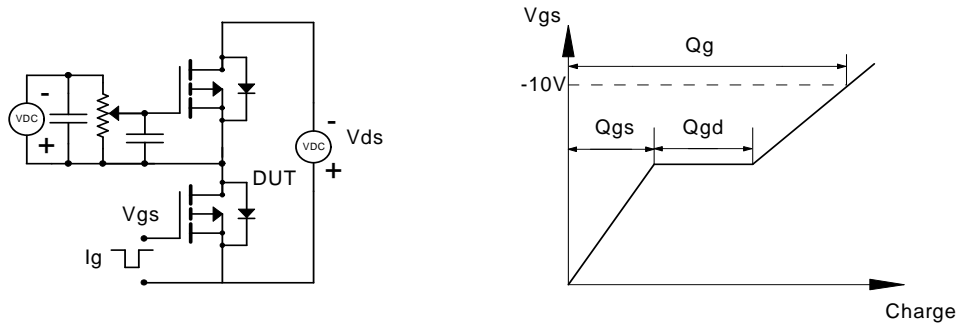

Figure 11: Normalized Maximum Transient Thermal Impedance

COMPLEMENTARY MOSFET

Gate Charge Test Circuit & Waveform



Resistive Switching Test Circuit & Waveforms

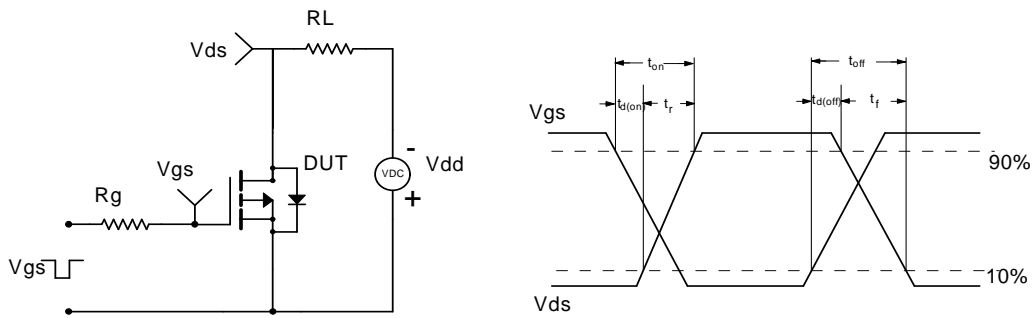

Unclamped Inductive Switching (UIS) Test Circuit & Waveforms

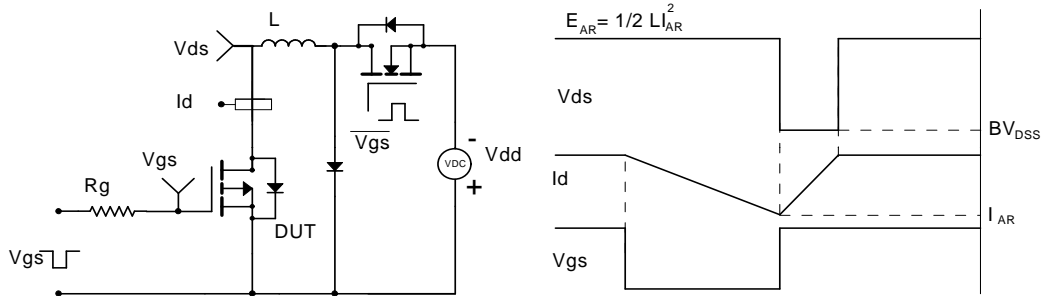

Diode Recovery Test Circuit & Waveforms

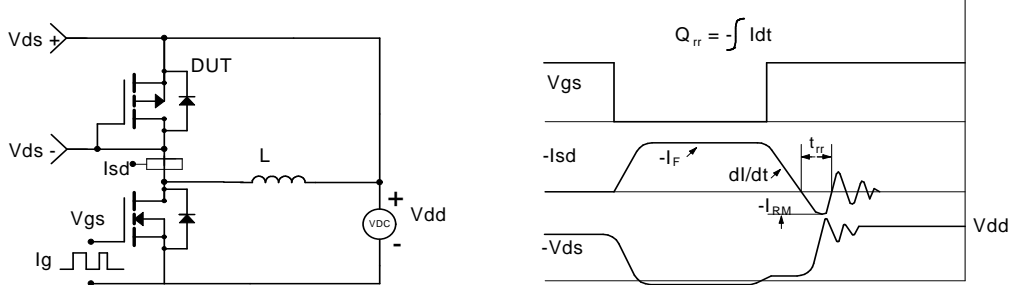

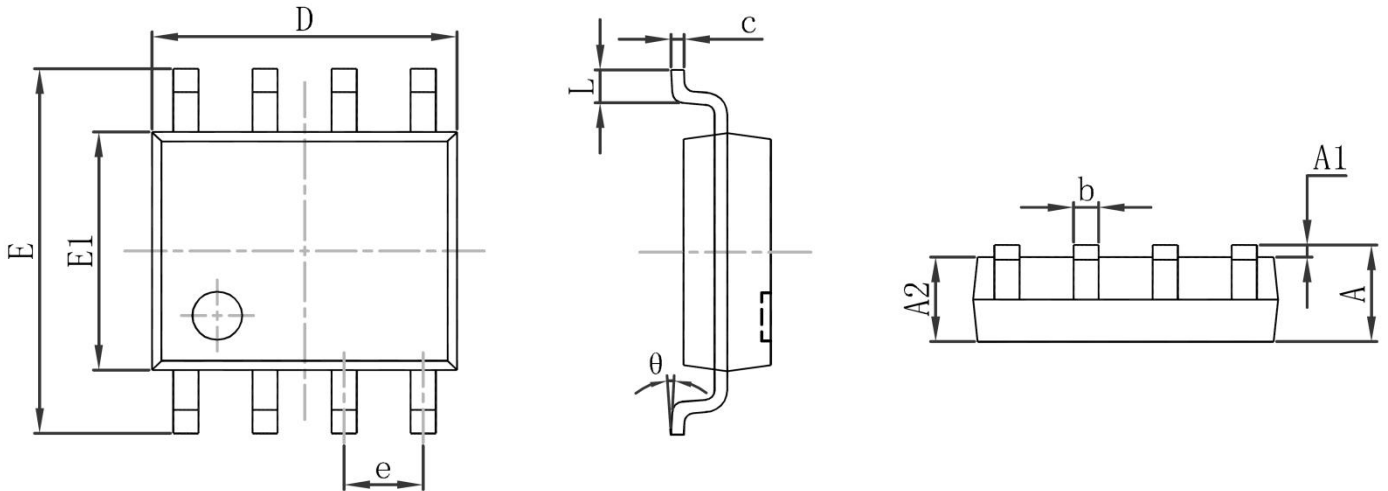
COMPLEMENTARY MOSFET
SOP-8 Package Outline Dimensions

Symbol	Dimensions In Millimeters		Dimensions In Inches	
	Min.	Max.	Min.	Max.
A	1.350	1.750	0.053	0.069
A1	0.100	0.250	0.004	0.010
A2	1.350	1.550	0.053	0.061
b	0.330	0.510	0.013	0.020
c	0.170	0.250	0.007	0.010
D	4.800	5.000	0.189	0.197
e	1.270(BSC)		0.050 (BSC)	
E	5.800	6.200	0.228	0.244
E1	3.800	4.000	0.150	0.157
L	0.400	1.270	0.016	0.050
θ	0°	8°	0°	8°

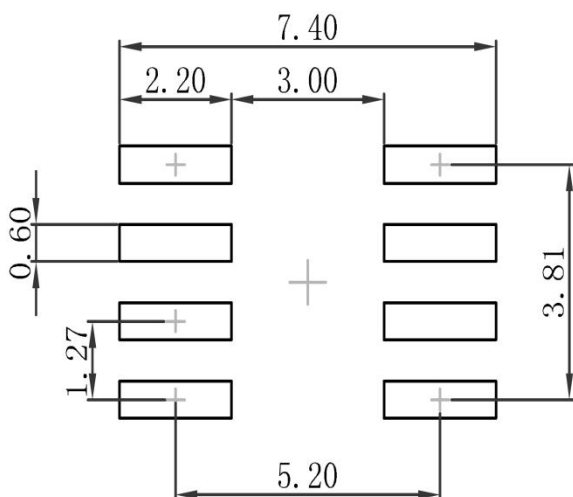
SOP-8 Suggested Pad Layout

Note:

1. Controlling dimension: in millimeters
2. General tolerance: $\pm 0.05\text{mm}$
3. The pad layout is for reference purposes only

COMPLEMENTARY MOSFET
SOP-8 Tape and Reel

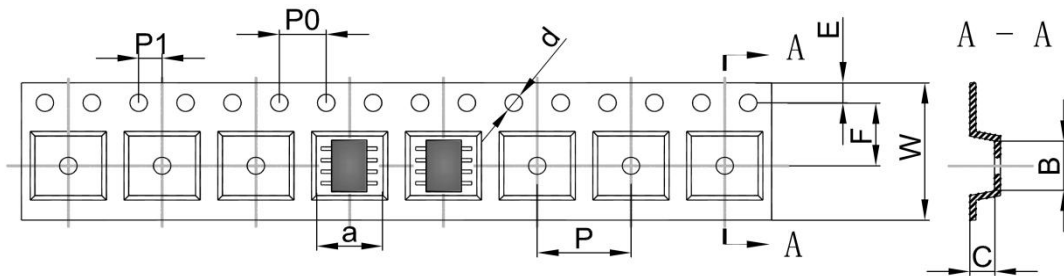
SOP-8 Embossed Carrier Tape



DIMENSIONS ARE IN MILLIMETER										
TYPE	A	B	C	d	E	F	P0	P	P1	W
SOP-8	6.40	5.40	2.10	Ø1.50	1.75	5.50	4.00	8.00	2.00	12.00
TOLERANCE	±0.1	±0.1	±0.1	±0.1	±0.1	±0.1	±0.1	±0.1	±0.1	±0.1

SOP-8 Tape Leader and Trailer

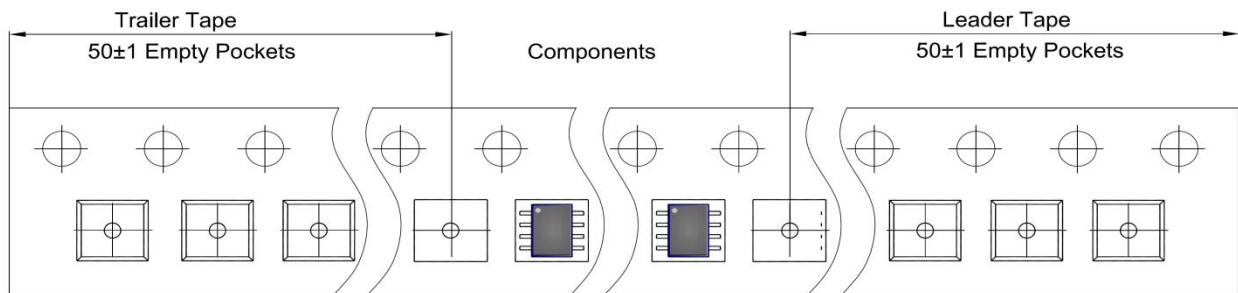

SOP-8 Reel

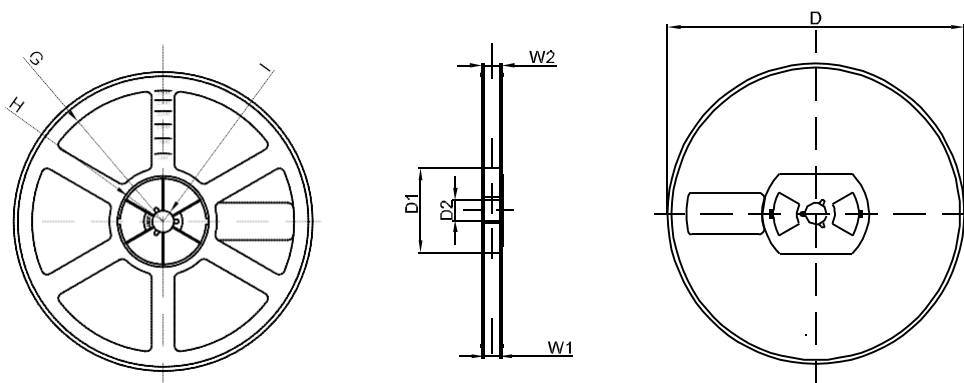

DIMENSIONS ARE IN MILLIMETER								
REEL OPTION	D	D1	D2	G	H	I	W1	W2
13" DIA	Ø330.00	100.00	13.00	R151.00	R56.00	R6.50	12.40	17.60
TOLERANCE	±2	±1	±1	±1	±1	±1	±1	±1