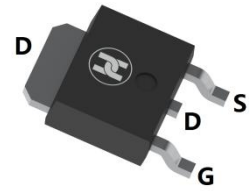
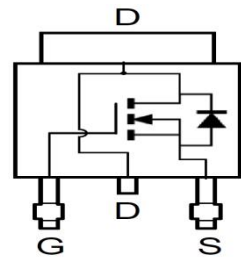

N-CHANNEL HIGH VOLTAGE MOSFET
FEATURES

- $V_{DS}=100V, R_{DS(ON)} \leq 85m\Omega @ V_{GS}=10V, I_D=7.7A$
- Low input capacitance
- Low on-resistance
- Fast switching speed
- For Power Management Functions and DC-DC Converters Applications
- For Disconnect switches and Motor control Applications
- For Uninterrupted power supply Applications
- Surface Mount device

TO-252
MECHANICAL DATA

- Case: TO-252
- Case Material: Molded Plastic. UL flammability
- Classification Rating: 94V-0
- Moisture Sensitivity: Level 1 per J-STD-020
- Weight: 0.33 grams (approximate)

MAXIMUM RATINGS ($T_A = 25^\circ\text{C}$ unless otherwise noted)

Parameter		Symbol	Value	Unit
Drain-source voltage		V_{DS}	100	V
Gate-source voltage		V_{GS}	± 20	V
Continuous drain current, $V_{GS} = 10V$	$T_c = +25^\circ\text{C}$ (NOTE2)	I_D	7.7	A
	$T_c = +70^\circ\text{C}$ (NOTE2)		6.2	
	$T_c = +25^\circ\text{C}$ (NOTE1)		5.0	
Pulsed drain current ($V_{GS}=10V$, Note3)		I_{DM}	27	A
Continuous Source current (Body diode)(Note2)		I_S	11	A
Pulsed Source current (Body diode)(Note3)		I_{SM}	27	A
Power dissipation	NOTE 1	P_D	4.31	W
	NOTE 2		10.1	
	NOTE 5		2.15	
Thermal resistance from Junction to ambient	NOTE 1	$R_{\theta JA}$	29	$^\circ\text{C}/\text{W}$
	NOTE 2		12.3	
	NOTE 5		58	
Thermal Resistance, Junction to Case (NOTE4)		$R_{\theta JL}$	1.14	$^\circ\text{C}/\text{W}$
Operating and Storage temperature		T_J, T_{STG}	-55 ~ +150	$^\circ\text{C}$

Notes:1. For a device surface mounted on 50mm x 50mm x 1.6mm FR4 PCB with high coverage of single sided 2oz copper, in still air conditions; the device is measured when operating in a steady-state condition.

2. Same as note 1, except the device is measured at $t \leq 10$ sec.

3. Same as note 1, except the device is pulsed with $D = 0.02$ and pulse width 300 μs . The pulse current is limited by the maximum junction temperature.

4. Thermal resistance from junction to solder-point (at the end of the drain lead).

5. For a device surface mounted on 25mm x 25mm x 1.6mm FR4 PCB with the high coverage single sided 1oz copper, in still air conditions; the device is measured when operating in a steady-state condition.

N-CHANNEL HIGH VOLTAGE MOSFET
ELECTRICAL CHARACTERISTICS (T_A = 25°C unless otherwise specified)

Parameter	Symbol	Min	Typ	Max	Unit	Conditions
OFF CHARACTERISTICS						
Drain-Source breakdown voltage	V _{(BR)DSS}	100			V	V _{GS} =0V, I _D =250μA
Zero gate voltage drain current	I _{DSS}			1	μA	V _{DS} =100V, V _{GS} =0V
Gate-body leakage current	I _{GSS}			±100	nA	V _{DS} =0V, V _{GS} =±20V
ON CHARACTERISTICS						
Gate-threshold voltage	V _{GS(th)}	2		4	V	V _{DS} =V _{GS} , I _D =250μA
Drain-source on-resistance (Note 6)	R _{DS(on)}			85	mΩ	V _{GS} =10V, I _D =4.6A
				100	mΩ	V _{GS} =6V, I _D =4.2A
Forward Trans-conductance (Note 6 &7)	g _{fs}		10.7		S	V _{DS} =15V, I _D =4.6A
Diode forward voltage (Note 6)	V _{SD}		0.85	0.95	V	I _S =4.7A, V _{GS} =0V
Body Diode Reverse Recovery Time(Note7)	t _{rr}		40		nS	I _S =3.0A, di/dt= 100A/μs
Body Diode Reverse Recovery Charge(Note7)	Q _{rr}		62		nC	
DYNAMIC CHARACTERISTICS(Note7)						
Input capacitance	C _{iss}		1313		pF	V _{DS} =50V, V _{GS} =0V, f=1MHz
Output capacitance	C _{oss}		83		pF	
Reverse transfer capacitance	C _{rss}		56		pF	
Total Gate Charge(Note8)	Q _g		17.2		nC	V _{DS} =50V, V _{GS} =6V, I _D =4.6A
Total gate charge(Note8)	Q _g		26.0		nC	V _{DS} =50V, V _{GS} =10V, I _D =4.6A
Gate-source charge(Note8)	Q _{gs}		5.6		nC	
Gate-drain charge(Note8)	Q _{gd}		7.6		nC	
Turn-on delay time(Note8)	t _{d(on)}		6.8		nS	V _{DD} =50V, V _{GS} =10V I _D =1.0A, R _g =25Ω
Turn-on rise time(Note8)	t _r		5.3		nS	
Turn-off delay time(Note8)	t _{d(off)}		27.5		nS	
Turn-off fall time(Note8)	t _f		12.3		nS	

Notes: 6. Measured under pulsed conditions. Pulse width ≤ 300μs; duty cycle ≤ 2%

7. For design aid only, not subject to production testing.

8. Switching characteristics are independent of operating junction temperatures.

N-CHANNEL HIGH VOLTAGE MOSFET

Thermal Characteristics

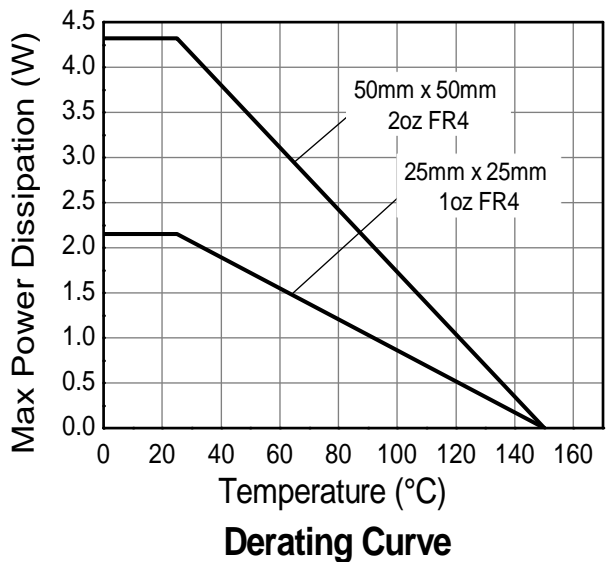
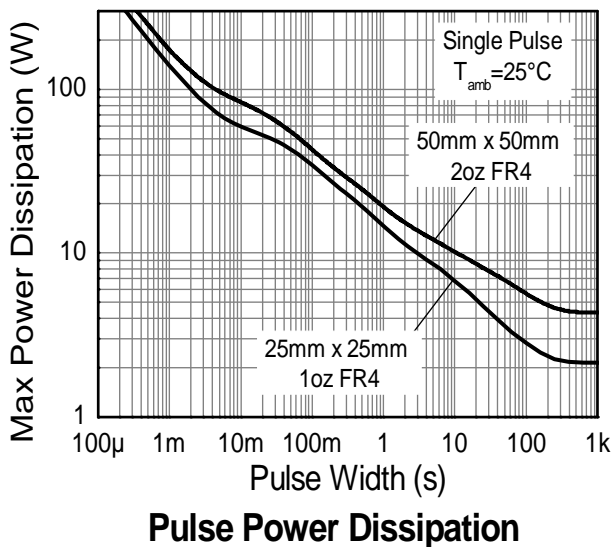
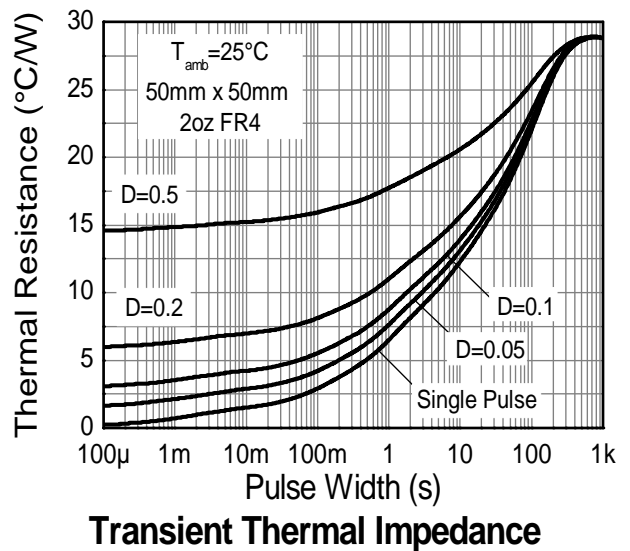
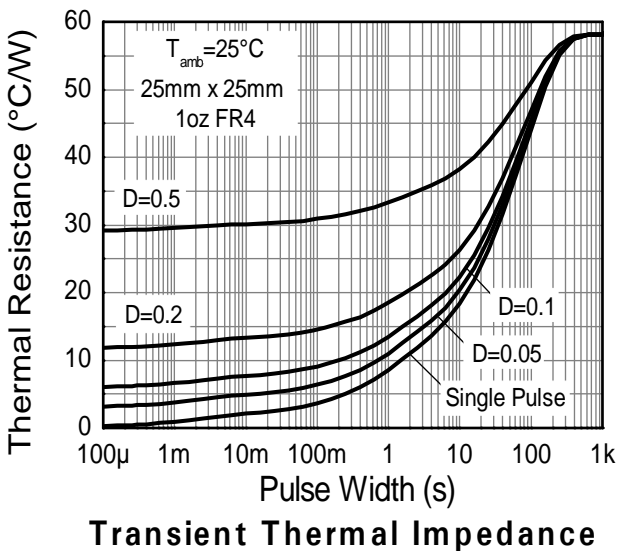
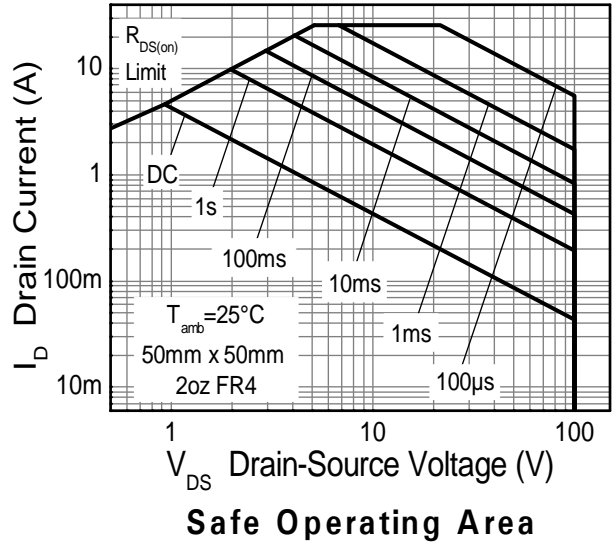
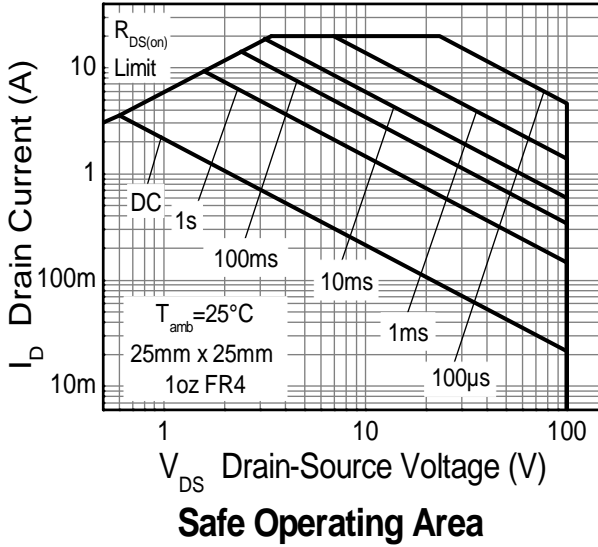

N-CHANNEL HIGH VOLTAGE MOSFET

Typical Characteristics

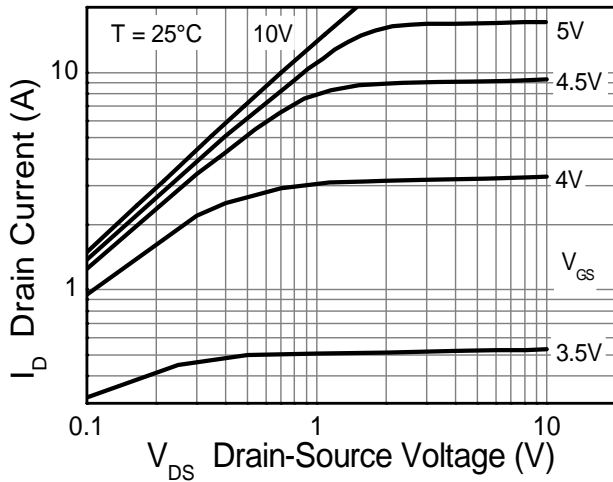

Output Characteristics

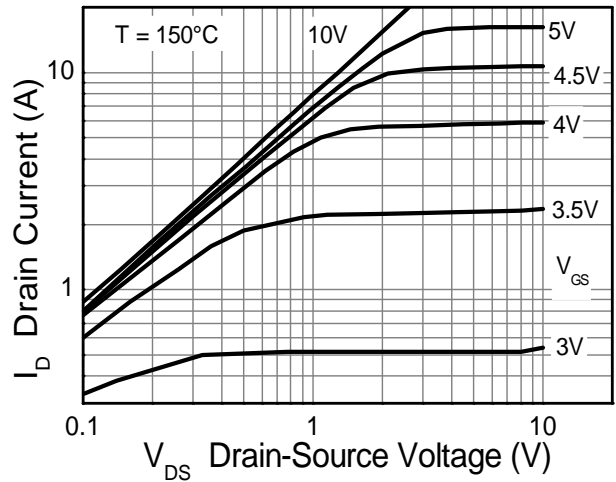

Output Characteristics

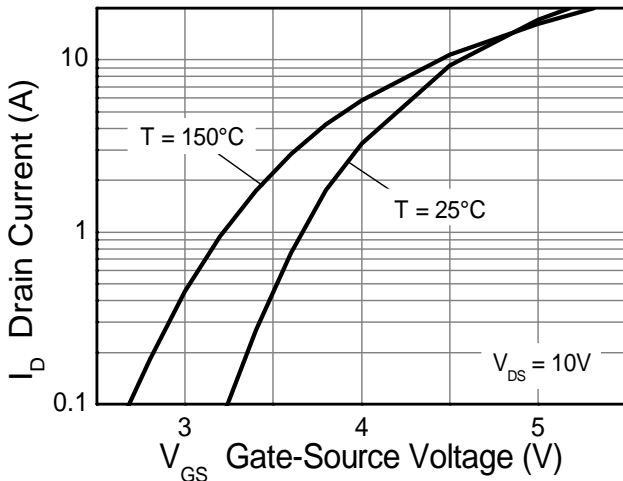

Typical Transfer Characteristics

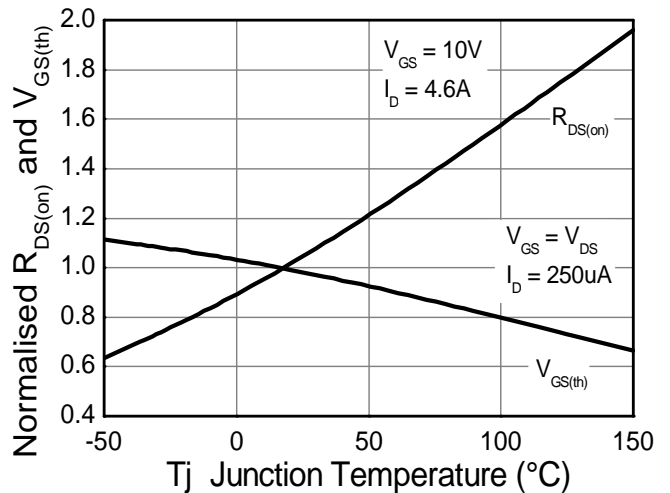

Normalised Curves v Temperature

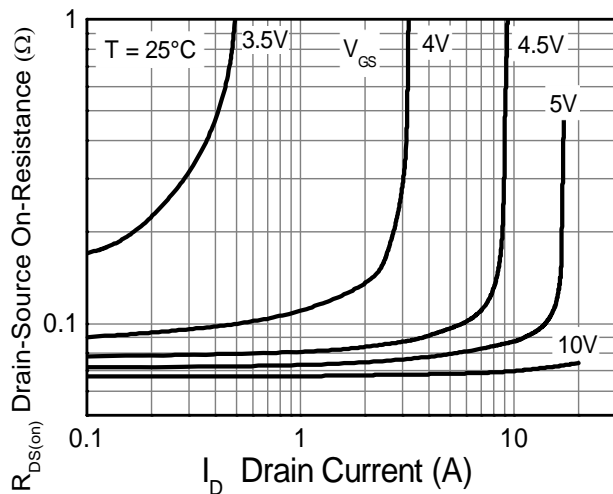

On-Resistance v Drain Current

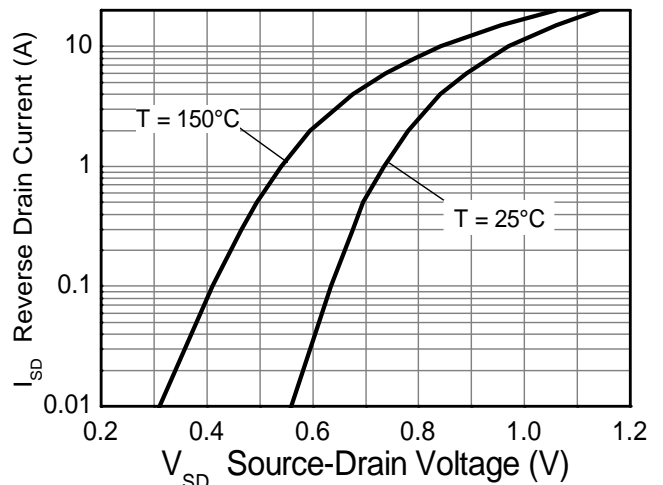

Source-Drain Diode Forward Voltage

N-CHANNEL HIGH VOLTAGE MOSFET

Typical Characteristics - continued

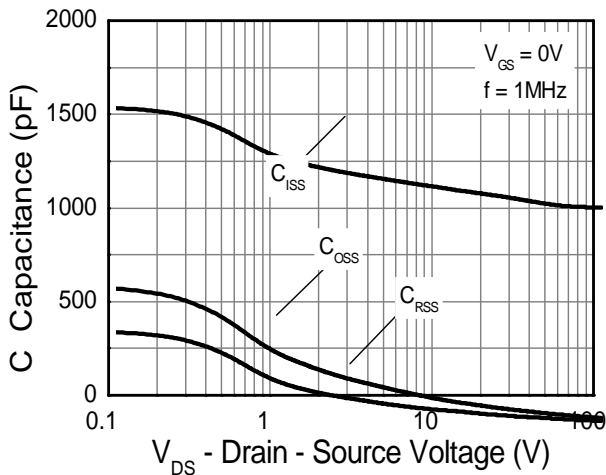

Capacitance v Drain-Source Voltage

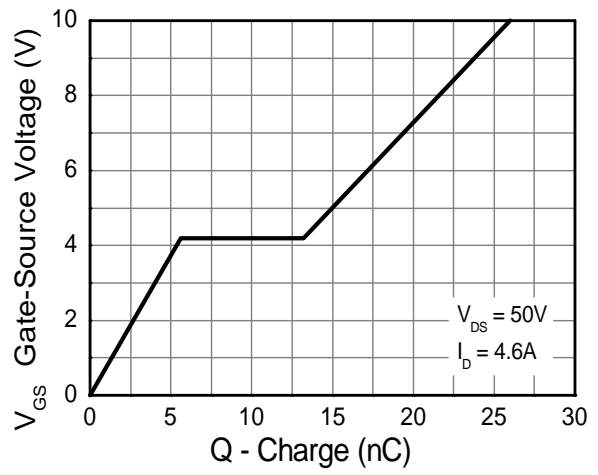

Gate-Source Voltage v Gate Charge

Test Circuits

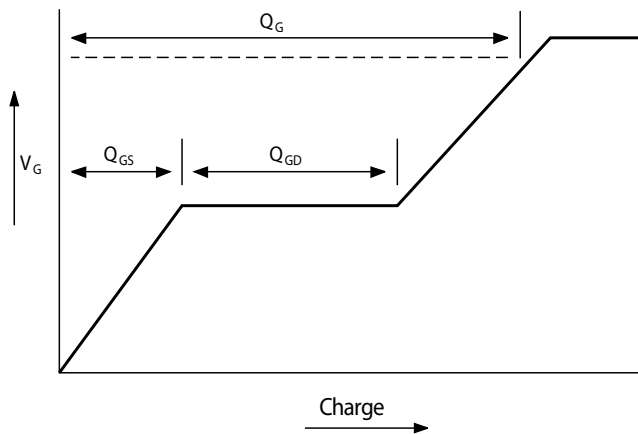

Basic gate charge waveform

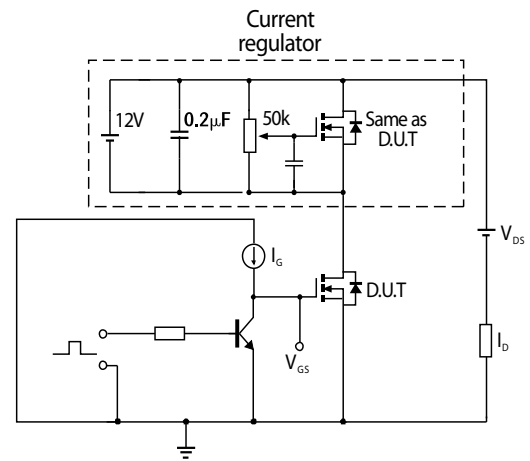

Gate charge test circuit

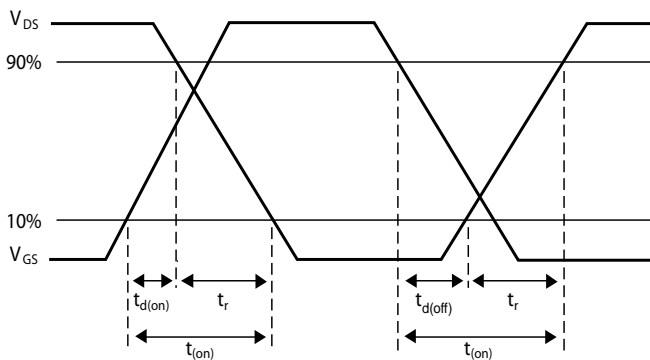

Switching time waveforms

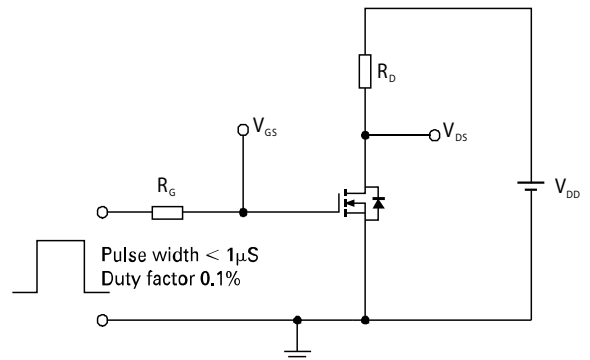

Switching time test circuit

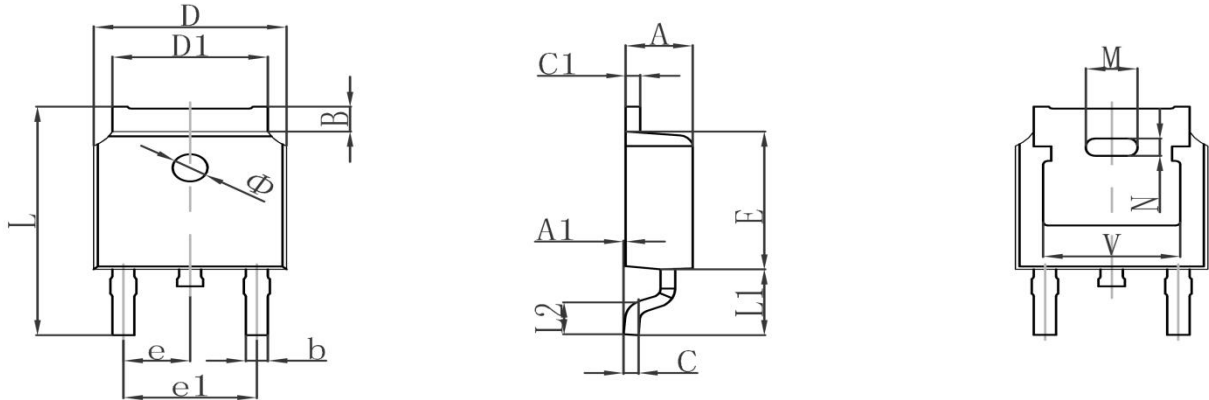
N-CHANNEL HIGH VOLTAGE MOSFET
TO-252 Package Outline Dimensions

Symbol	Dimensions In Millimeters		Dimensions In Inches	
	Min.	Max.	Min.	Max.
A	2.200	2.380	0.087	0.094
A1	0.000	0.100	0.000	0.004
B	0.800	1.400	0.031	0.055
b	0.710	0.810	0.028	0.032
c	0.460	0.560	0.018	0.022
c1	0.460	0.560	0.018	0.022
D	6.500	6.700	0.256	0.264
D1	5.130	5.460	0.202	0.215
E	6.000	6.200	0.236	0.244
e	2.286TYP		0.090TYP	
e1	4.327	4.727	0.170	0.186
M	1.778REF		0.070REF	
N	0.762REF		0.018REF	
L	9.800	10.400	0.386	0.409
L1	2.9REF		0.114REF	
L2	1.400	1.700	0.055	0.067
V	4.830REF		0.190REF	
Φ	1.100	1.300	0.043	0.051

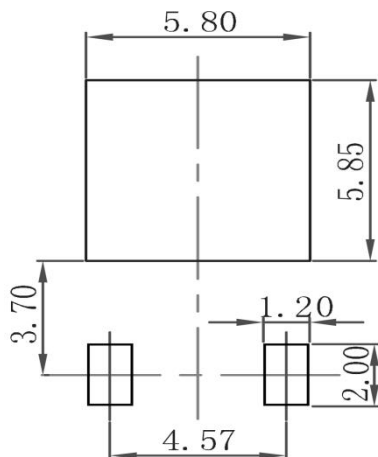
TO-252 Suggested Pad Layout

Note:

1. Controlling dimension: in millimeters
2. General tolerance: $\pm 0.05\text{mm}$
3. The pad layout is for reference purposes only

N-CHANNEL HIGH VOLTAGE MOSFET

TO-252 Tape and Reel

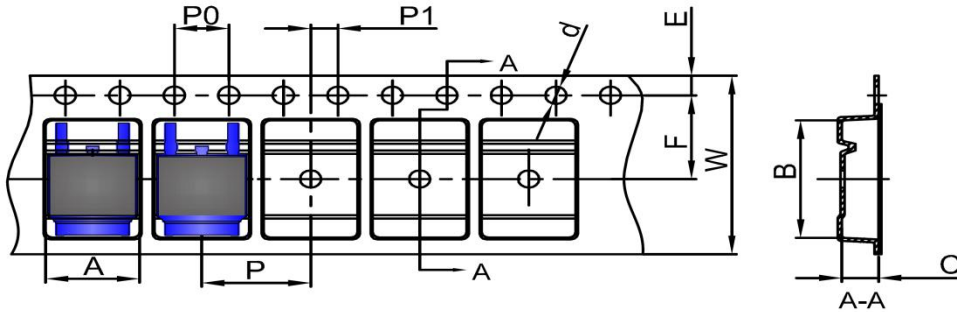
TO-252 Embossed Carrier Tape



DIMENSIONS ARE IN MILLIMETER										
TYPE	A	B	C	d	E	F	P0	P	P1	W
TO-252	6.90	10.50	2.70	Ø1.55	1.75	7.50	4.00	8.00	2.00	16.00
TOLERANCE	±0.1	±0.1	±0.1	±0.1	±0.1	±0.1	±0.1	±0.1	±0.1	±0.1

TO-252 Tape Leader and Trailer

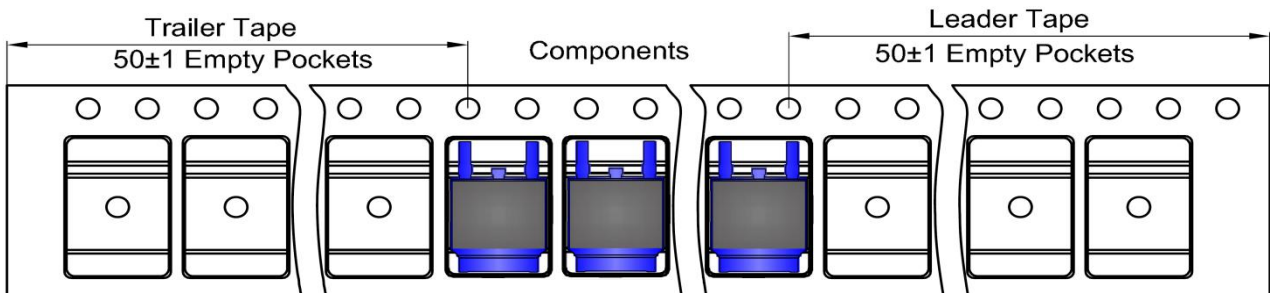

TO-252 Reel

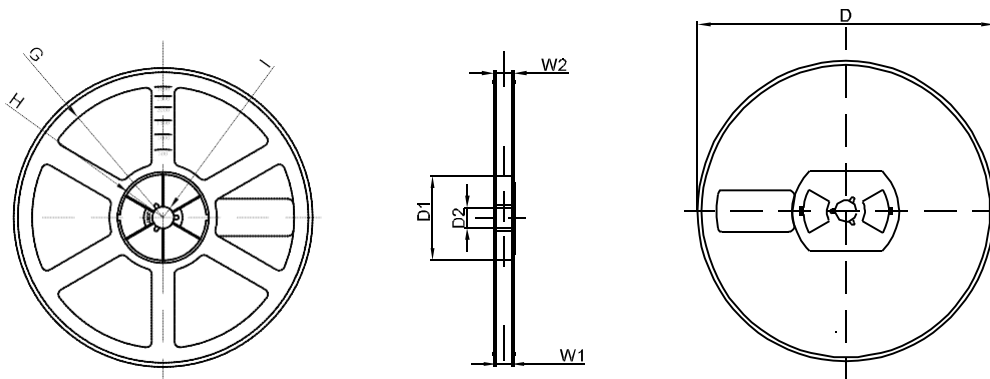

DIMENSIONS ARE IN MILLIMETER								
REEL OPTION	D	D1	D2	G	H	I	W1	W2
13" DIA	Ø330.00	100.00	Φ21.00	R151.00	R56.00	R6.50	16.40	21.00
TOLERANCE	±2	±1	±1	±1	±1	±1	±1	±1