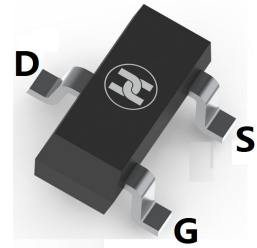
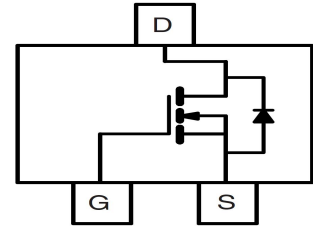

LOW VOLTAGE MOSFET (N-CHANNEL)
FEATURES

- $V_{DS}=30V, R_{DS(ON)} \leq 50m\Omega @ V_{GS}=4.5V, I_D=3.6A$
- Ultra low on-resistance
- For Low power DC to DC converter and Load switch applications
- Surface Mount device

SOT-23

MECHANICAL DATA

- Case: SOT-23
- Case Material: Molded Plastic. UL flammability
- Classification Rating: 94V-0
- Moisture Sensitivity: Level 1 per J-STD-020
- Weight: 0.008 grams (approximate)

MAXIMUM RATINGS ($T_A = 25^\circ\text{C}$ unless otherwise noted)

| Parameter | Symbol | Value | Unit |
|---|-----------------|------------|--------------------|
| Drain-source voltage | V_{DS} | 30 | V |
| Gate-source voltage | V_{GS} | ± 20 | V |
| Continuous drain current | I_D | 3.6 | A |
| Pulsed drain current (Note 1) | I_{DM} | 16 | A |
| Power dissipation | P_D | 0.96 | W |
| Thermal resistance from Junction to ambient | $R_{\theta JA}$ | 175 | $^\circ\text{C/W}$ |
| Junction temperature | T_J | 150 | $^\circ\text{C}$ |
| Storage temperature | T_{STG} | -55 ~ +150 | $^\circ\text{C}$ |

ELECTRICAL CHARACTERISTICS ($T_A = 25^\circ\text{C}$ unless otherwise specified)

| Parameter | Symbol | Min | Typ | Max | Unit | Conditions |
|-------------------------------------|---------------|-----|------|-----------|-----------|---|
| Drain-Source breakdown voltage | $V_{(BR)DSS}$ | 30 | | | V | $V_{GS}=0V, I_D=10\mu A$ |
| Zero gate voltage drain current | I_{DSS} | | | 1 | μA | $V_{DS}=24V, V_{GS}=0V$ |
| Gate-body leakage current | I_{GSS} | | | ± 100 | nA | $V_{DS}=0V, V_{GS}=\pm 20V$ |
| Gate-threshold voltage (note 1) | $V_{GS(th)}$ | 0.8 | | | V | $V_{DS}=V_{GS}, I_D=250\mu A$ |
| On-State Drain Current | $I_{D(ON)}$ | 6 | | | A | $V_{DS}=4.5V, V_{GS}=10V$ |
| | | 4 | | | A | $V_{DS}=4.5V, V_{GS}=4.5V$ |
| Drain-source on-resistance (note 1) | $R_{DS(ON)}$ | | 42 | 50 | $m\Omega$ | $V_{GS}=4.5V, I_D=3.6A$ |
| | | | 68 | 85 | $m\Omega$ | $V_{GS}=4.5V, I_D=2.6A$ |
| Forward transconductance (note 1) | g_{FS} | | 6 | | S | $V_{DS}=4.5V, I_D=3.4A$ |
| Input capacitance | C_{iss} | | 215 | | pF | $V_{DS}=15V, V_{GS}=0V, f=1MHz$ |
| Output capacitance | C_{oss} | | 90 | | pF | |
| Reverse transfer capacitance | C_{rss} | | 55 | | pF | |
| Turn-on delay time | $t_{d(on)}$ | | 9 | 15 | nS | $V_{DD}=15V, V_{GS}=10V, R_{GEN}=6\Omega, I_D=1A, R_L=15\Omega$ |
| Turn-on rise time | t_r | | 9 | 15 | nS | |
| Turn-off delay time | $t_{d(off)}$ | | 14 | 20 | nS | |
| Turn-off fall time | t_f | | 6 | 12 | nS | |
| Total gate charge | Q_g | | 4.3 | 7 | nC | $V_{DS}=15V, V_{GS}=10V, I_D=3.6A$ |
| Gate-source charge | Q_{gs} | | 0.65 | | nC | |
| Gate-drain charge | Q_{gd} | | 1.2 | | nC | |
| Diode forward voltage (note 1) | V_{SD} | | 0.88 | 1.2 | V | $I_S=0.94A, V_{GS}=0V$ |
| Diode forward current | I_S | | 0.8 | | A | $V_D=V_G=0V, V_S=1.2V$ |

Note:1. Pulse test ; Pulse width $\leq 300\mu s$, Duty cycle $\leq 2\%$.

LOW VOLTAGE MOSFET (N-CHANNEL)

Typical Characteristics

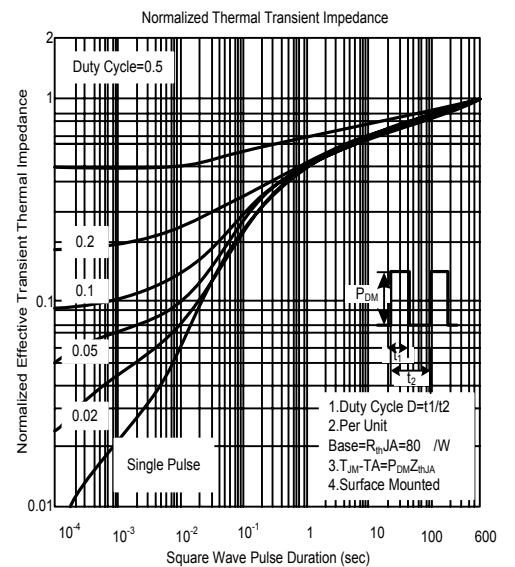
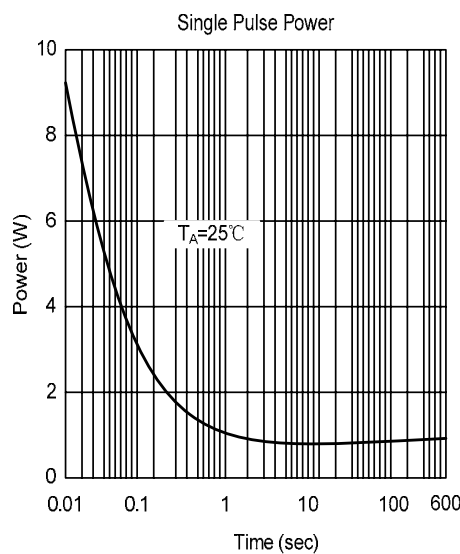
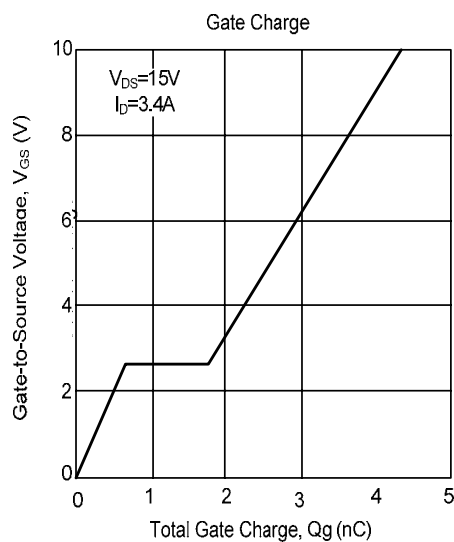
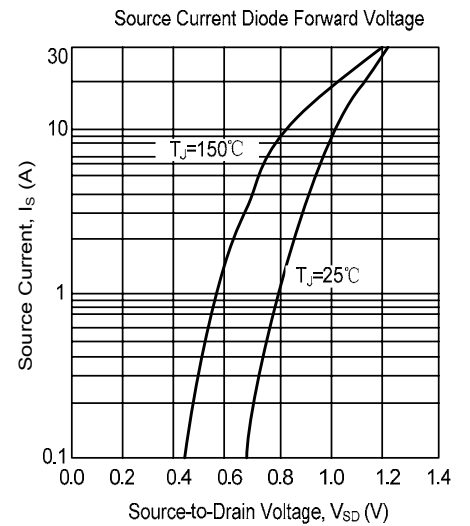
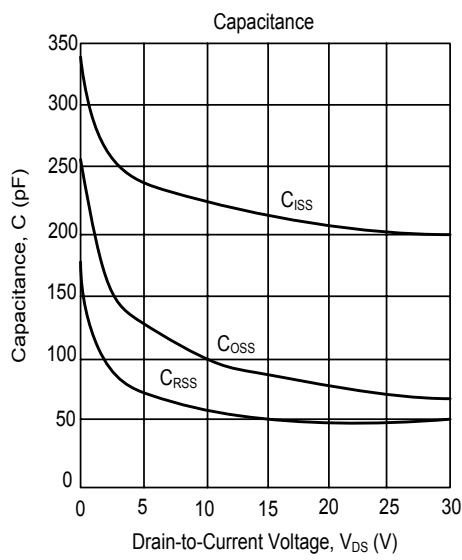
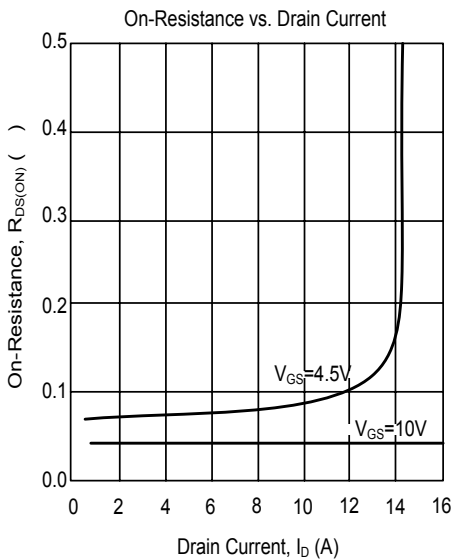
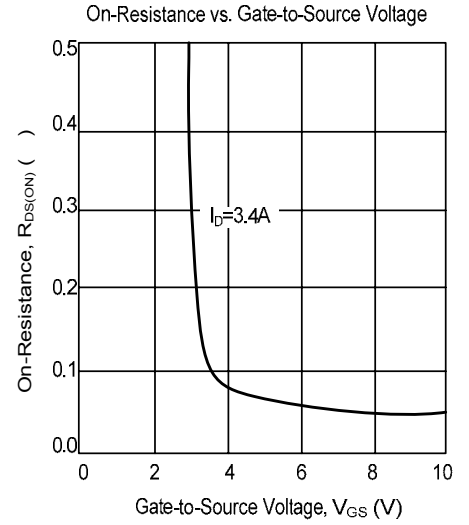
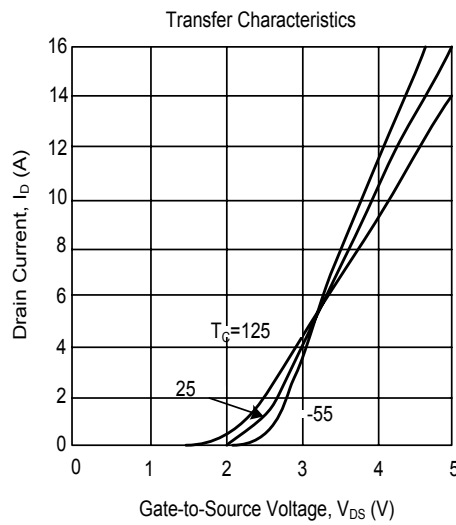
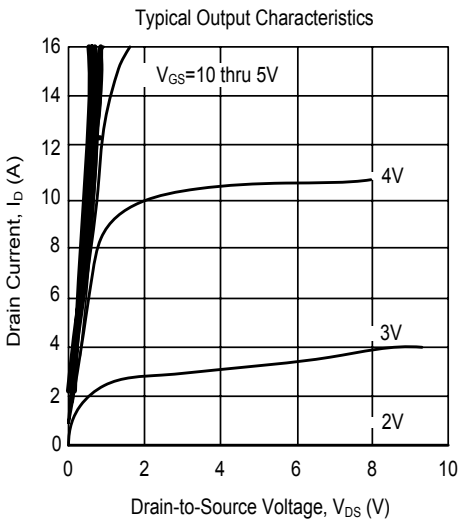

LOW VOLTAGE MOSFET (N-CHANNEL)

Typical Characteristics

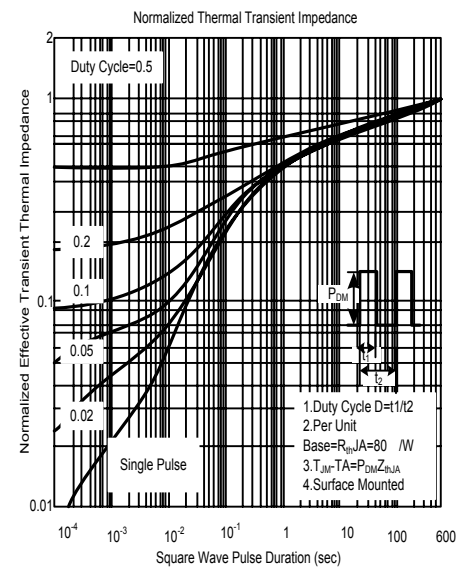
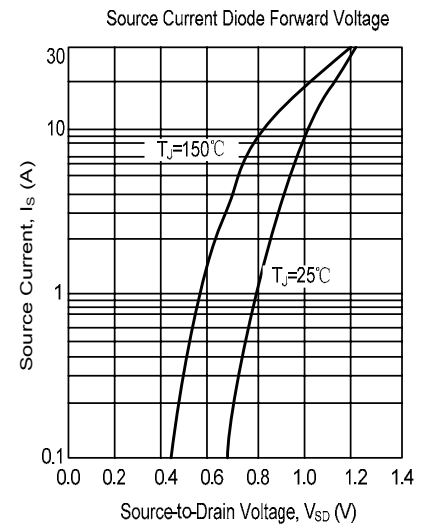
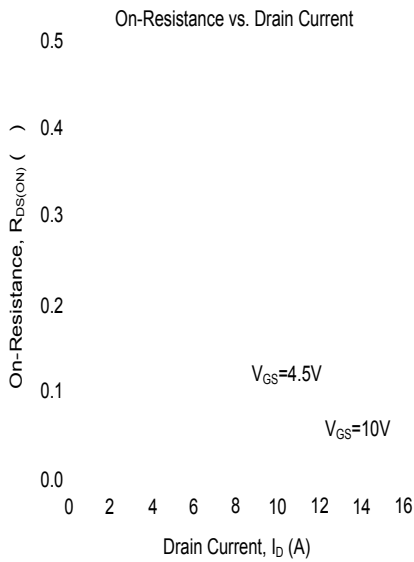
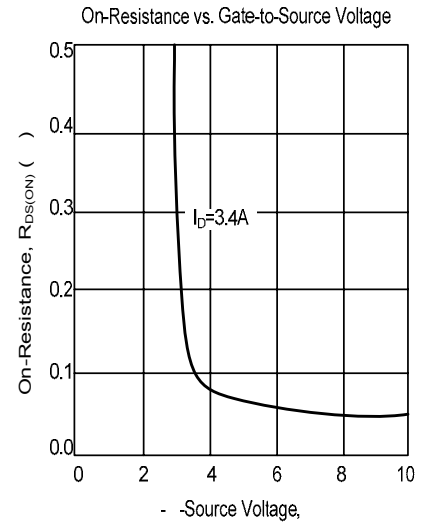
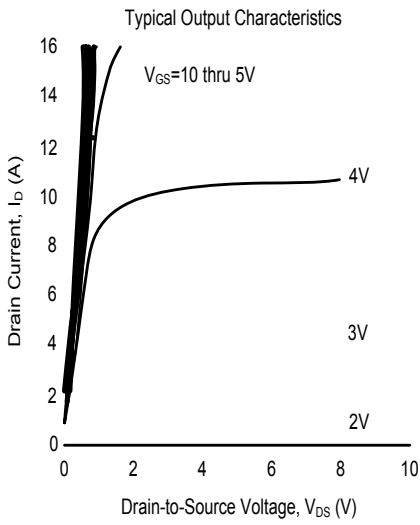

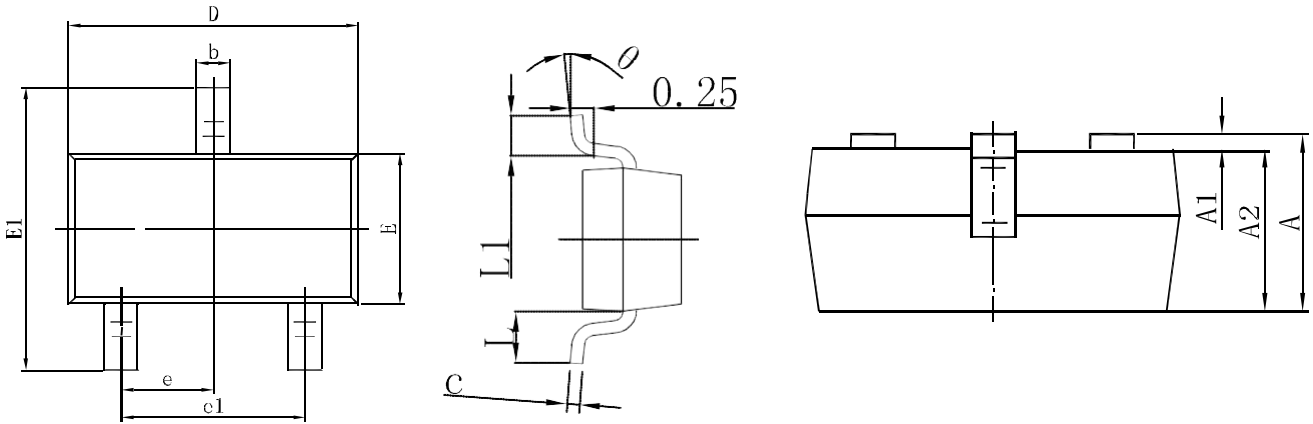
LOW VOLTAGE MOSFET (N-CHANNEL)
SOT-23 Package Outline Dimensions

| Symbol | Dimensions In Millimeters | | Dimensions In Inches | |
|--------|---------------------------|-------|----------------------|-------|
| | Min. | Max. | Min. | Max. |
| A | 0.900 | 1.150 | 0.035 | 0.045 |
| A1 | 0.000 | 0.100 | 0.000 | 0.004 |
| A2 | 0.900 | 1.050 | 0.035 | 0.041 |
| b | 0.300 | 0.500 | 0.012 | 0.020 |
| c | 0.080 | 0.150 | 0.003 | 0.006 |
| D | 2.800 | 3.000 | 0.110 | 0.118 |
| E | 1.200 | 1.400 | 0.047 | 0.055 |
| E1 | 2.250 | 2.550 | 0.089 | 0.100 |
| e | 0.950 TYP | | 0.037 TYP | |
| e1 | 1.800 | 2.000 | 0.071 | 0.079 |
| L | 0.550 REF | | 0.022 REF | |
| L1 | 0.300 | 0.500 | 0.012 | 0.020 |
| θ | 0° | 8° | 0° | 8° |

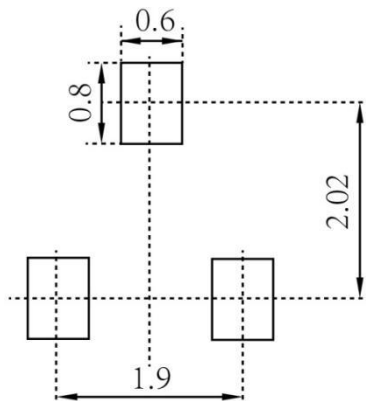
SOT-23 Suggested Pad Layout

Note:

1. Controlling dimension: in millimeters
2. General tolerance: $\pm 0.05\text{mm}$
3. The pad layout is for reference purposes only

LOW VOLTAGE MOSFET (N-CHANNEL)

SOT-23 Tape and Reel

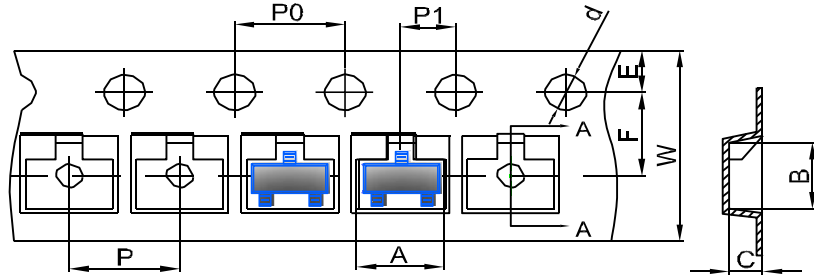
SOT-23 Embossed Carrier Tape



| DIMENSIONS ARE IN MILLIMETER | | | | | | | | | | |
|------------------------------|------|------|------|-------|------|------|------|------|------|------|
| TYPE | A | B | C | d | E | F | P0 | P | P1 | W |
| SOT-23 | 3.15 | 2.77 | 1.22 | Ø1.50 | 1.75 | 3.50 | 4.00 | 4.00 | 2.00 | 8.00 |
| TOLERANCE | ±0.1 | ±0.1 | ±0.1 | ±0.1 | ±0.1 | ±0.1 | ±0.1 | ±0.1 | ±0.1 | ±0.1 |

SOT-23 Tape Leader and Trailer

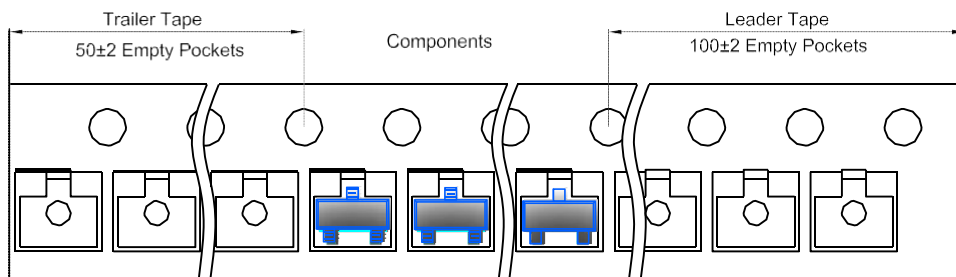

SOT-23 Reel

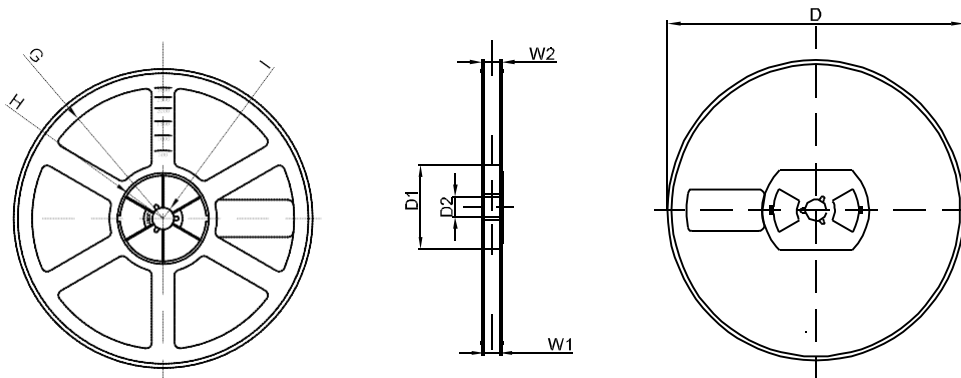

| DIMENSIONS ARE IN MILLIMETER | | | | | | | | |
|------------------------------|------|-------|-------|-----|--------|-------|------|-------|
| REEL OPTION | D | D1 | D2 | G | H | I | W1 | W2 |
| 7" DIA | Ø178 | 54.40 | 13.00 | R78 | R25.60 | R6.50 | 9.50 | 12.30 |
| TOLERANCE | ±2 | ±1 | ±1 | ±1 | ±1 | ±1 | ±1 | ±1 |