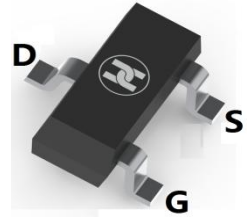
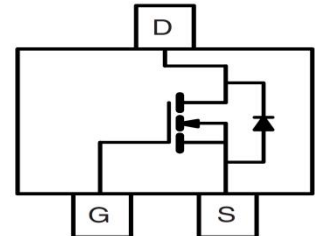

HIGH VOLTAGE MOSFET (N-CHANNEL)
FEATURES

- $V_{DS}=100V, R_{DS(ON)}=10\Omega @ V_{GS}=10V, I_D=0.1A$
- Complementary Type - HMP3310F
- Surface Mount device

SOT-23

MECHANICAL DATA

- Case: SOT-23
- Case Material: Molded Plastic. UL flammability
- Classification Rating: 94V-0
- Moisture Sensitivity: Level 1 per J-STD-020
- Weight: 0.008 grams (approximate)

MAXIMUM RATINGS ($T_A = 25^\circ\text{C}$ unless otherwise noted)

Parameter	Symbol	Value	Unit
Drain-source voltage	V_{DS}	100	V
Gate-source voltage	V_{GS}	± 20	V
Continuous drain current	I_D	0.1	A
Pulsed drain current	I_{DM}	2	A
Power dissipation	P_D	0.33	W
Junction temperature	T_J	150	$^\circ\text{C}$
Storage temperature	T_{STG}	-55 ~ +150	$^\circ\text{C}$

ELECTRICAL CHARACTERISTICS ($T_A = 25^\circ\text{C}$ unless otherwise specified)

Parameter	Symbol	Min	Typ	Max	Unit	Conditions
STATIC CHARACTERISTICS						
Drain-Source breakdown voltage	$V_{(BR)DSS}$	100			V	$V_{GS}=0V, I_D=1mA$
Zero gate voltage drain current	I_{DSS}			1	μA	$V_{DS}=100V, V_{GS}=0V$
				50	μA	$V_{DS}=80V, V_{GS}=0V, T=125^\circ\text{C}$
Gate-body leakage current	I_{GSS}			± 20	nA	$V_{DS}=0V, V_{GS}=\pm 20V$
Gate-threshold voltage	$V_{GS(th)}$	0.8		2.4	V	$V_{DS}=V_{GS}, I_D=1mA$
On-State Drain Current(note 1)	$I_{D(ON)}$	500			mA	$V_{DS}=25V, V_{GS}=10V$
Drain-source on-resistance (note 1)	$R_{DS(ON)}$			10	Ω	$V_{GS}=10V, I_D=0.5A$
Forward Trans-conductance(note 1,2)	g_{fs}	100			mS	$V_{DS}=25V, I_D=0.5A$
DYNAMIC CHARACTERISTICS						
Input capacitance(note2)	C_{iss}			40	pF	$V_{DS}=25V, V_{GS}=0V, f=1MHz$
Output capacitance(note2)	C_{oss}			15	pF	
Reverse transfer capacitance(note2)	C_{rss}			5	pF	
Turn-on delay time(note2,3)	$t_{d(on)}$		3	5	nS	$V_{DS}=25V, I_D=0.5A$
Turn-on rise time(note2,3)	t_r		5	7	nS	
Turn-off delay time(note2,3)	$t_{d(off)}$		4	6	nS	
Turn-off fall time(note2,3)	t_f		5	7	nS	

Note:(1) Measured under pulsed conditions. Width=300 μs . Duty cycle $\leq 2\%$

(2) Sample test.

(3) Switching times measured with 50W source impedance and <5ns rise time on a pulse generator

HIGH VOLTAGE MOSFET (N-CHANNEL)

Typical Characteristics

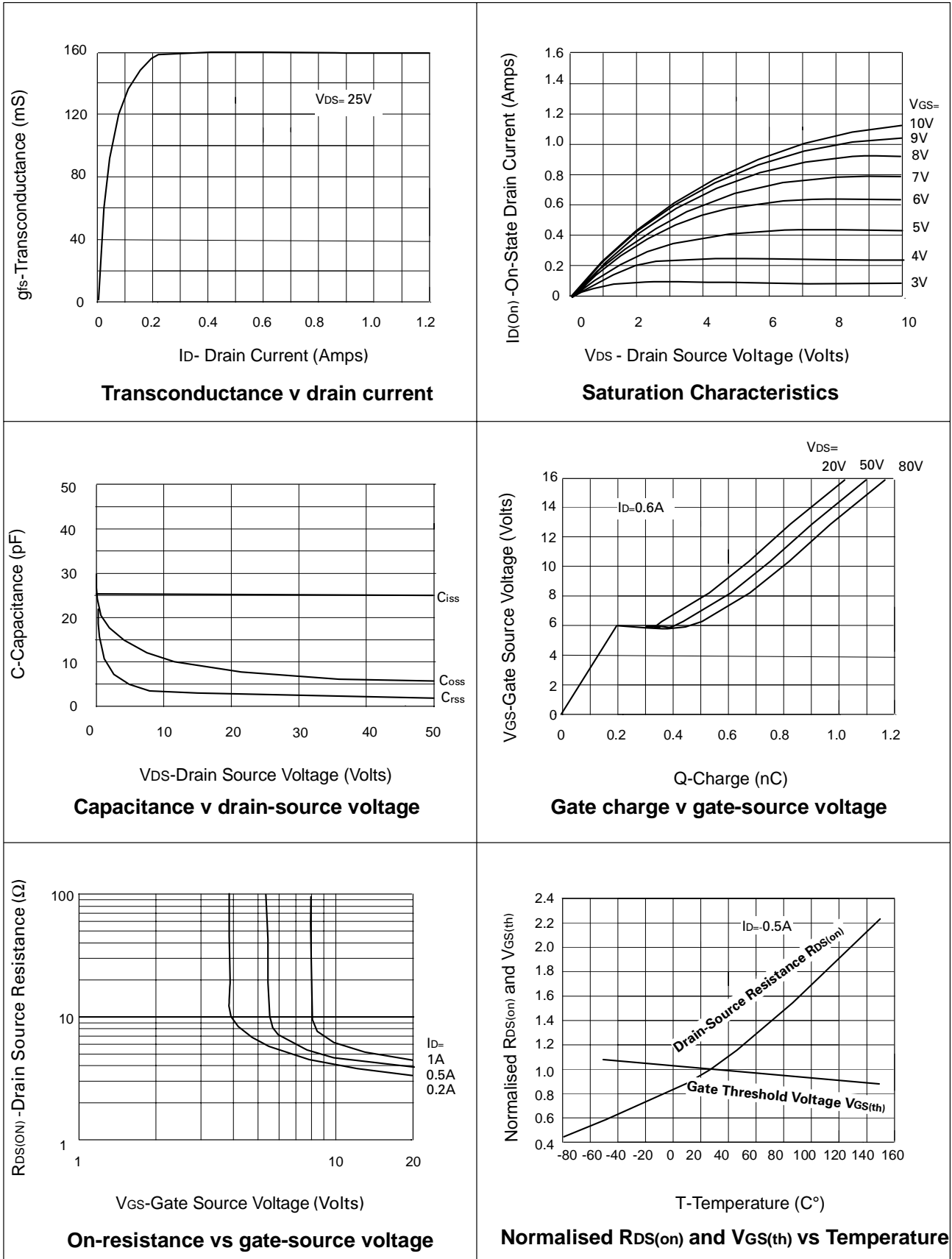

HIGH VOLTAGE MOSFET (N-CHANNEL)
SOT-23 Package Outline Dimensions

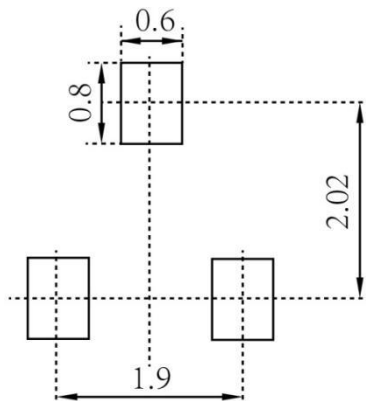

Symbol	Dimensions In Millimeters		Dimensions In Inches	
	Min.	Max.	Min.	Max.
A	0.900	1.150	0.035	0.045
A1	0.000	0.100	0.000	0.004
A2	0.900	1.050	0.035	0.041
b	0.300	0.500	0.012	0.020
c	0.080	0.150	0.003	0.006
D	2.800	3.000	0.110	0.118
E	1.200	1.400	0.047	0.055
E1	2.250	2.550	0.089	0.100
e	0.950 TYP		0.037 TYP	
e1	1.800	2.000	0.071	0.079
L	0.550 REF		0.022 REF	
L1	0.300	0.500	0.012	0.020
θ	0°	8°	0°	8°

SOT-23 Suggested Pad Layout

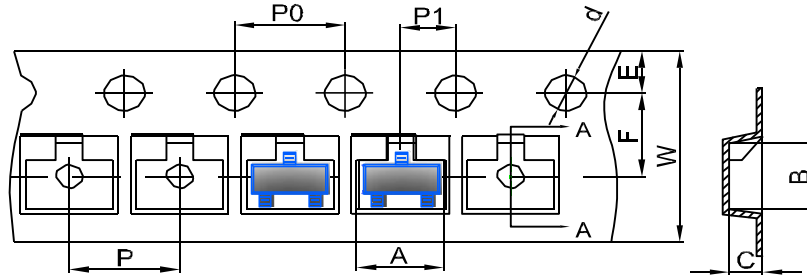
Note:

1. Controlling dimension: in millimeters
2. General tolerance: $\pm 0.05\text{mm}$
3. The pad layout is for reference purposes only

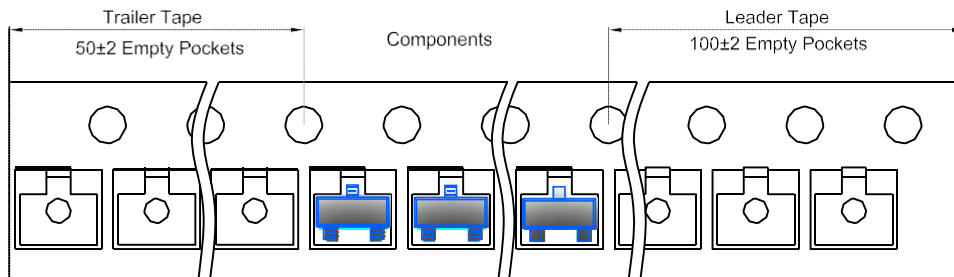
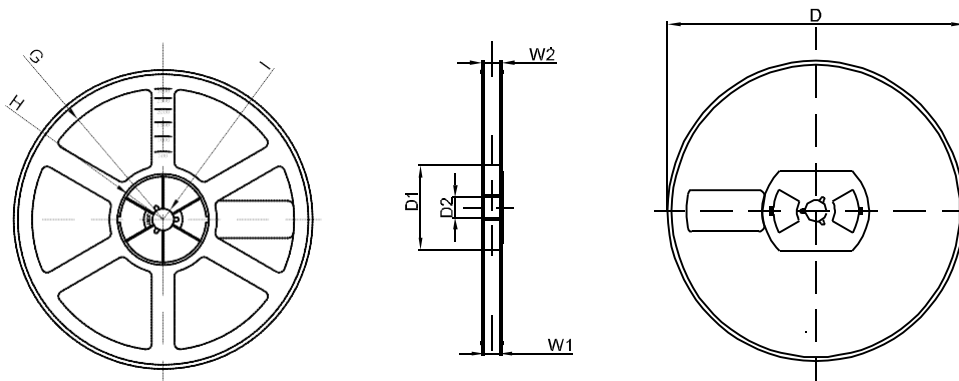
HIGH VOLTAGE MOSFET (N-CHANNEL)
SOT-23 Tape and Reel
SOT-23 Embossed Carrier Tape

DIMENSIONS ARE IN MILLIMETER										
TYPE	A	B	C	d	E	F	P0	P	P1	W
SOT-23	3.15	2.77	1.22	Ø1.50	1.75	3.50	4.00	4.00	2.00	8.00
TOLERANCE	±0.1	±0.1	±0.1	±0.1	±0.1	±0.1	±0.1	±0.1	±0.1	±0.1

SOT-23 Tape Leader and Trailer

SOT-23 Reel

DIMENSIONS ARE IN MILLIMETER								
REEL OPTION	D	D1	D2	G	H	I	W1	W2
7" DIA	Ø178	54.40	13.00	R78	R25.60	R6.50	9.50	12.30
TOLERANCE	±2	±1	±1	±1	±1	±1	±1	±1