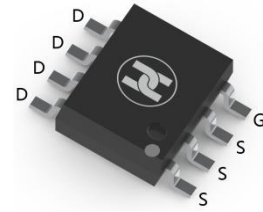
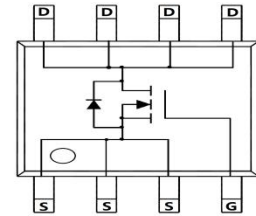

**LOW VOLTAGE MOSFET (N-CHANNEL)**
**FEATURES**

- Ultra low on-resistance:  $V_{DS}=30V, I_D=16A, R_{DS(ON)} \leq 7.2m\Omega @ V_{GS}=10V$
- Low gate charge and operation with gate voltages
- For load switch and general purpose applications
- Surface Mount device

**SOP-8**

**MECHANICAL DATA**

- Case: SOP-8
- Case Material: Molded Plastic. UL flammability
- Classification Rating: 94V-0
- Moisture Sensitivity: Level 1 per J-STD-020
- Weight: 0.3 grams (approximate)

**MAXIMUM RATINGS ( $T_A = 25^\circ C$  unless otherwise noted)**

Parameter	Symbol	Value	Unit
Drain-source voltage	$V_{DS}$	30	V
Gate-source voltage	$V_{GS}$	$\pm 20$	V
Continuous drain current	$I_D$	$T_A = 25^\circ C$	16
		$T_A = 70^\circ C$	13
Pulsed drain current	$I_{DM}$	120	A
Avalanche current	$I_{AS}, I_{AR}$	30	A
Avalanche energy L=0.1mH	$E_{AS}, E_{AR}$	135	mJ
Power dissipation	$P_D$	$T_A = 25^\circ C$	2.8
		$T_A = 70^\circ C$	1.8
Thermal resistance from Junction to ambient	$R_{\theta JA}$	75	$^\circ C/W$
Thermal resistance from Junction to Lead	$R_{\theta JL}$	24	$^\circ C/W$
Junction temperature	$T_J$	150	$^\circ C$
Storage temperature	$T_{STG}$	-55 ~ +150	$^\circ C$

**ELECTRICAL CHARACTERISTICS ( $T_A = 25^\circ C$  unless otherwise specified)**

Parameter	Symbol	Min	Typ	Max	Unit	Conditions
Drain-Source breakdown voltage	$V_{(BR)DSS}^*$	30			V	$V_{GS}=0V, I_D=250\mu A$
Zero gate voltage drain current	$I_{DSS}^*$			1	$\mu A$	$V_{DS}=30V, V_{GS}=0V$
Gate-body leakage current	$I_{GSS}^*$			10	nA	$V_{DS}=0V, V_{GS}=\pm 16V$
Gate-threshold voltage	$V_{GS(th)}^*$	1.4	1.8	2.5	V	$V_{DS}=V_{GS}, I_D=250\mu A$
On-State Drain Current	$I_{D(ON)}$	120			A	$V_{DS}=5V, V_{GS}=10V$
Drain-source on-resistance	$R_{DS(ON)}^*$		6	7.2	m $\Omega$	$V_{GS}=10V, I_D=16A$
			8.5	10	m $\Omega$	$V_{GS}=10V, I_D=16A, T_J=125^\circ C$
			8	10	m $\Omega$	$V_{GS}=4.5V, I_D=12A$
Forward transconductance	$g_{FS}$		55		S	$V_{DS}=5V, I_D=16A$
Diode forward voltage	$V_{SD}$		0.70	1.0	V	$I_S=1A, V_{GS}=0V$
Diode forward current	$I_S$			4	A	
Input capacitance	$C_{iss}$		1803	2170	pF	$V_{DS}=15V, V_{GS}=0V, f=1MHz$
Output capacitance	$C_{oss}$		387		pF	
Reverse transfer capacitance	$C_{rss}$		238		pF	
Gate resistance	$R_g$		1.3	2	$\Omega$	$V_{DS}=0V, V_{GS}=0V, f=1MHz$
Total gate charge	$Q_g$		19		nC	$V_{GS}=4.5V, V_{DS}=15V, I_D=16A$
Total gate charge			36	48	nC	
Gate-source charge	$Q_{gs}$		3.9		nC	$V_{GS}=10V, V_{DS}=15V, I_D=16A$
Gate-drain charge	$Q_{gd}$		8.7		nC	
Turn-on delay time	$t_{d(on)}$		7.6		nS	
Turn-on rise time	$t_r$		6.4		nS	$V_{GS}=10V, V_{DS}=15V, R_{GEN}=3\Omega, R_L=1\Omega$
Turn-off delay time	$t_{d(off)}$		27		nS	
Turn-off fall time	$t_f$		8.5		nS	
Body Diode Reverse Recovery Time	$t_{rr}$		27	33	nS	$I_F=16A, di/dt=500A/\mu s$
Body Diode Reverse Recovery Charge	$Q_{rr}$		17		nC	$I_F=16A, di/dt=500A/\mu s$

\*Pulse test ; Pulse width  $\leq 300\mu s$ , Duty cycle  $\leq 0.5\%$  .

**LOW VOLTAGE MOSFET (N-CHANNEL)**

**Typical Characteristics**

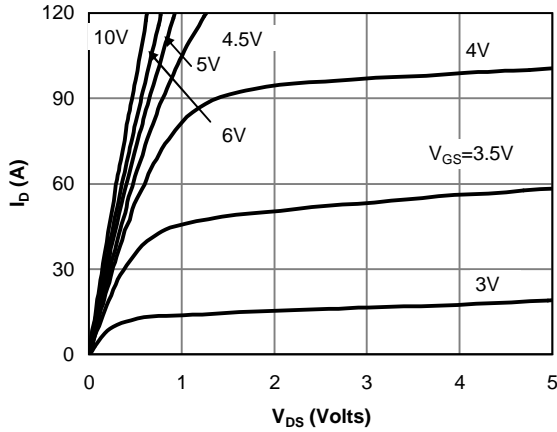

**Figure 1: On-Region Characteristics**

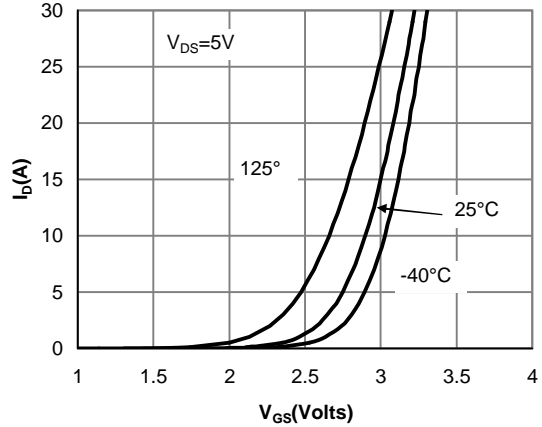

**Figure 2: Transfer Characteristics**

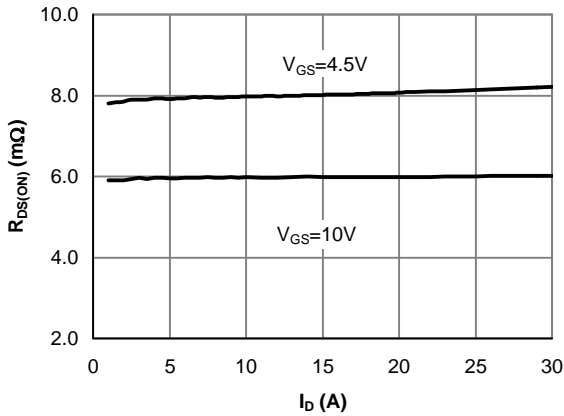

**Figure 3: On-Resistance vs. Drain Current and Gate Voltage**

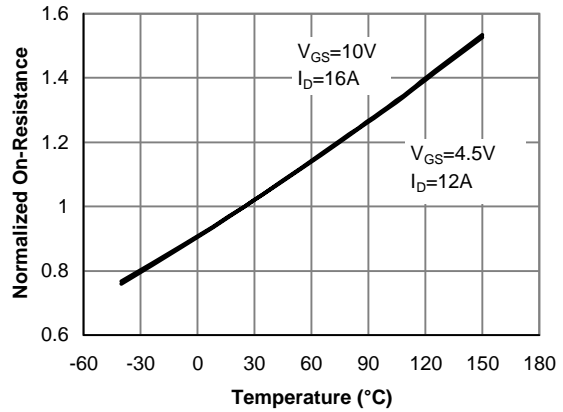

**Figure 4: On-Resistance vs. Junction Temperature**

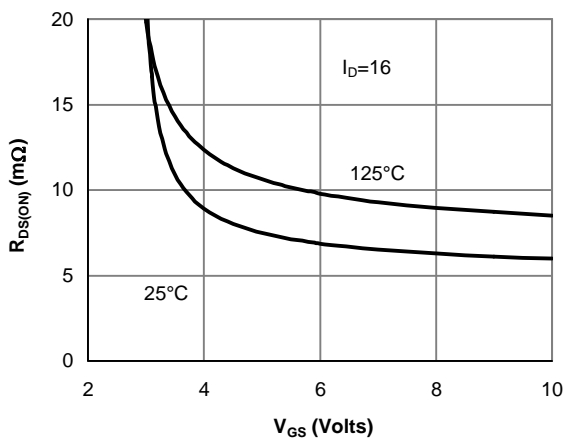

**Figure 5: On-Resistance vs. Gate-Source Voltage**

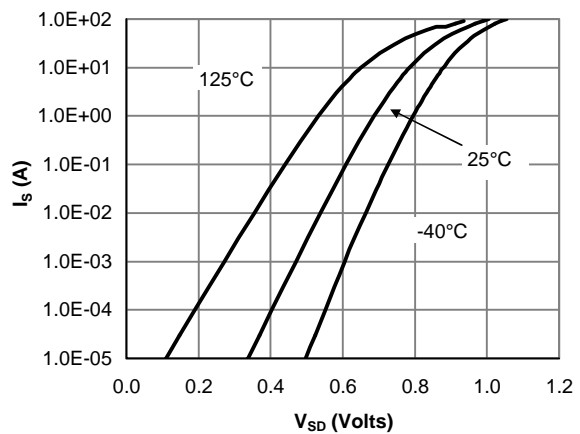

**Figure 6: Body-Diode Characteristics**

**LOW VOLTAGE MOSFET (N-CHANNEL)**

**TYPICAL ELECTRICAL AND THERMAL CHARACTERISTICS**

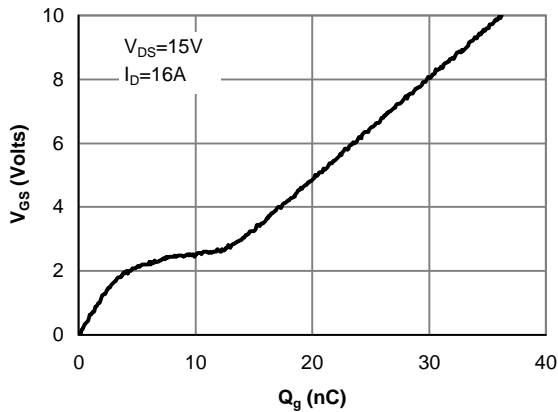

**Figure 7: Gate-Charge Characteristics**

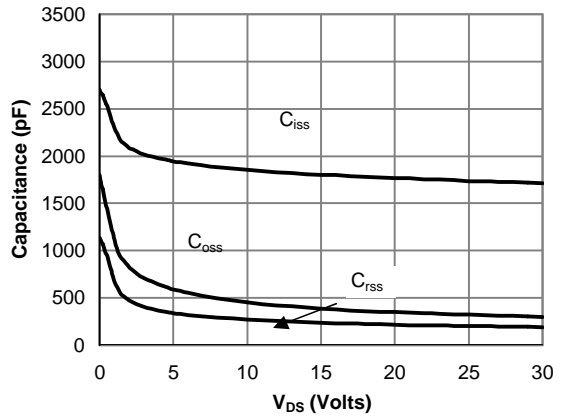

**Figure 8: Capacitance Characteristics**

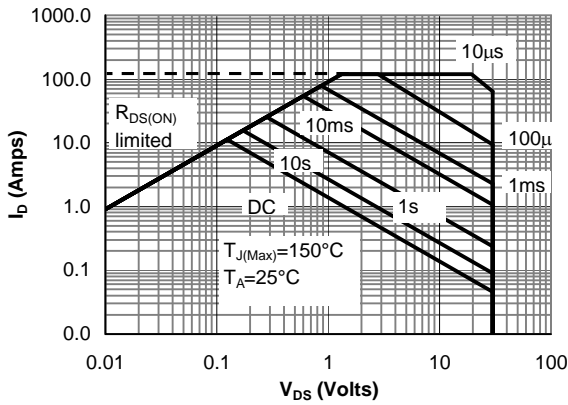

**Figure 9: Maximum Forward Biased Safe Operating Area**

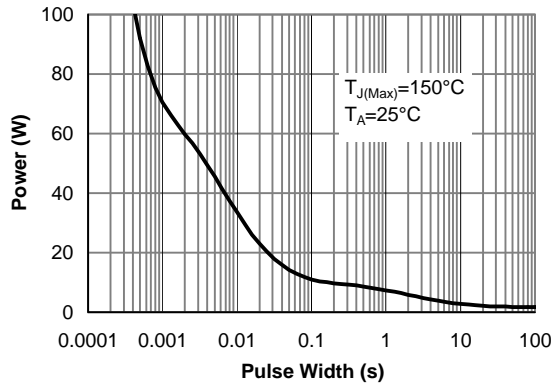

**Figure 10: Single Pulse Power Rating Junction-to-Ambient**

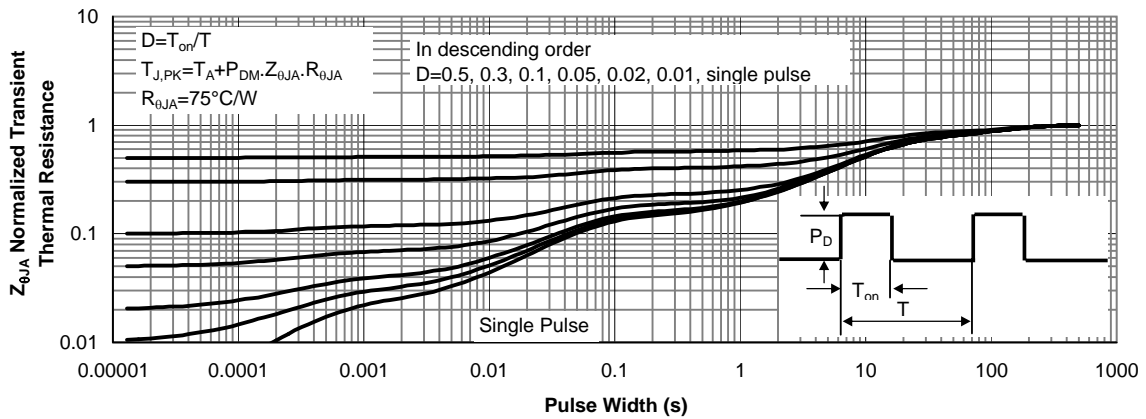

**Figure 11: Normalized Maximum Transient Thermal Impedance**

**LOW VOLTAGE MOSFET (N-CHANNEL)**

**TYPICAL ELECTRICAL AND THERMAL CHARACTERISTICS**

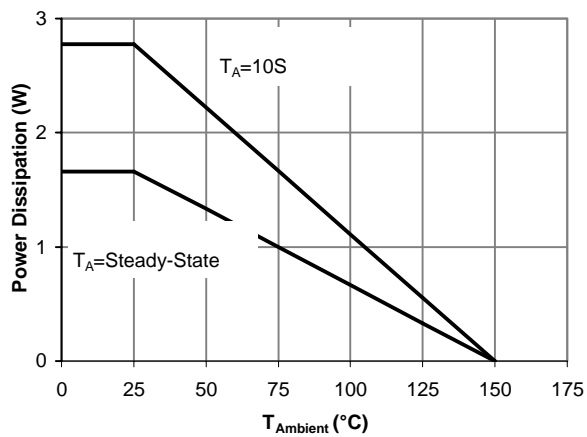

**Figure 12: Power De-rating**

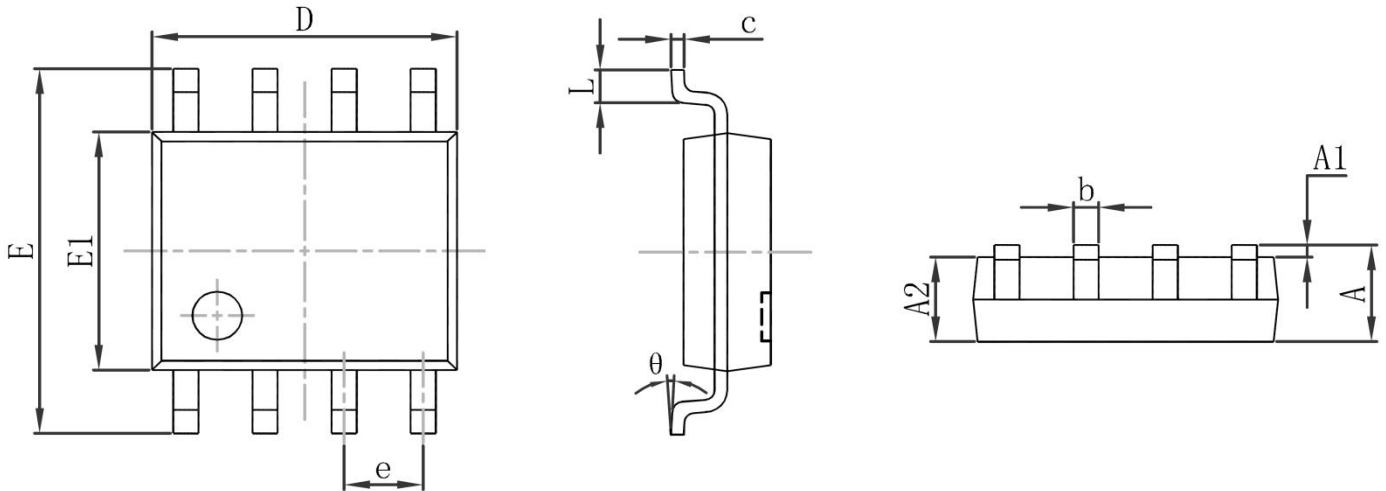
**LOW VOLTAGE MOSFET (N-CHANNEL)**
**SOP-8 Package Outline Dimensions**

Symbol	Dimensions In Millimeters		Dimensions In Inches	
	Min.	Max.	Min.	Max.
A	1.350	1.750	0.053	0.069
A1	0.100	0.250	0.004	0.010
A2	1.350	1.550	0.053	0.061
b	0.330	0.510	0.013	0.020
c	0.170	0.250	0.007	0.010
D	4.800	5.000	0.189	0.197
e	1.270(BSC)		0.050 (BSC)	
E	5.800	6.200	0.228	0.244
E1	3.800	4.000	0.150	0.157
L	0.400	1.270	0.016	0.050
$\theta$	0°	8°	0°	8°

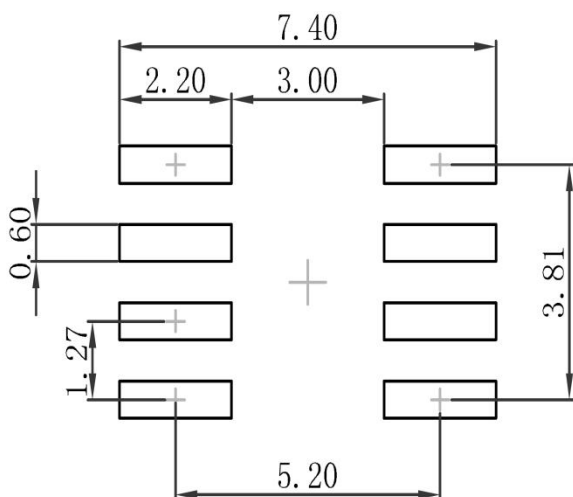
**SOP-8 Suggested Pad Layout**

**Note:**

1. Controlling dimension: in millimeters
2. General tolerance:  $\pm 0.05\text{mm}$
3. The pad layout is for reference purposes only

LOW VOLTAGE MOSFET (N-CHANNEL)

SOP-8 Tape and Reel

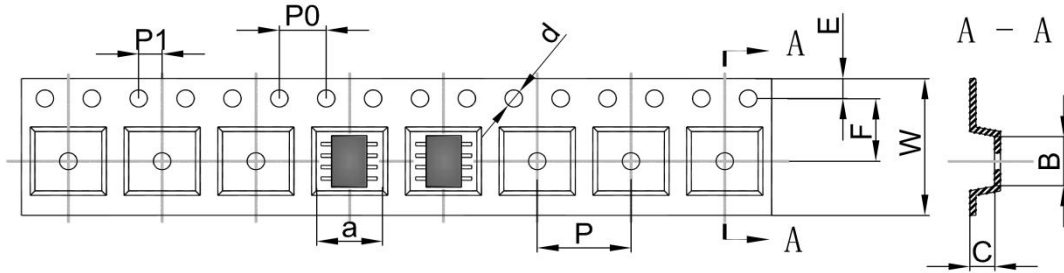
SOP-8 Embossed Carrier Tape



DIMENSIONS ARE IN MILLIMETER										
TYPE	A	B	C	d	E	F	P0	P	P1	W
SOP-8	6.40	5.40	2.10	Ø1.50	1.75	5.50	4.00	8.00	2.00	12.00
TOLERANCE	±0.1	±0.1	±0.1	±0.1	±0.1	±0.1	±0.1	±0.1	±0.1	±0.1

SOP-8 Tape Leader and Trailer

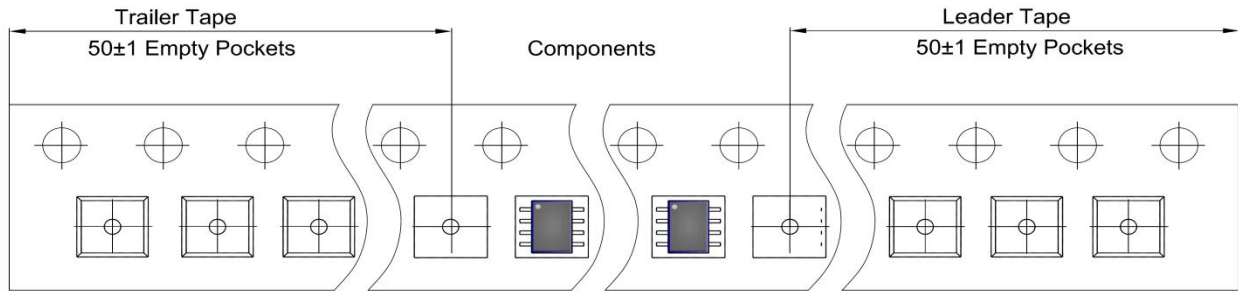

SOP-8 Reel

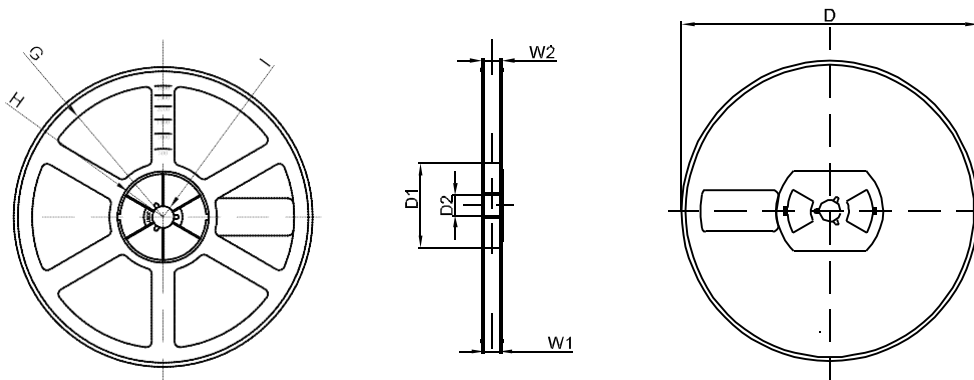

DIMENSIONS ARE IN MILLIMETER								
REEL OPTION	D	D1	D2	G	H	I	W1	W2
13" DIA	Ø330.00	100.00	13.00	R151.00	R56.00	R6.50	12.40	17.60
TOLERANCE	±2	±1	±1	±1	±1	±1	±1	±1