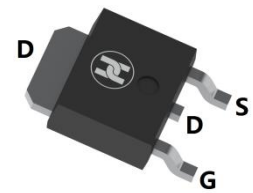
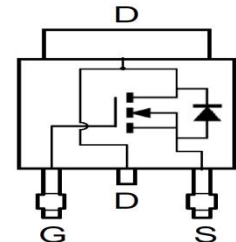

N-CHANNEL HIGH VOLTAGE MOSFET
FEATURES

- $V_{DS}=100V, R_{DS(ON)} \leq 28m\Omega @ V_{GS}=10V, I_D=55A$
- Low $R_{DS(ON)}$ – – Minimises Power Losses
- Low Q_g – Minimises Switching Losses
- For Power Management Functions and DC-DC Converters Applications
- Surface Mount device

TO-252

MECHANICAL DATA

- Case: TO-252
- Case Material: Molded Plastic. UL flammability
- Classification Rating: 94V-0
- Moisture Sensitivity: Level 1 per J-STD-020
- Weight: 0.33 grams (approximate)

MAXIMUM RATINGS ($T_A = 25^\circ C$ unless otherwise noted)

Parameter	Symbol	Value	Unit
Drain-source voltage	V_{DS}	100	V
Gate-source voltage	V_{GS}	± 20	V
Continuous drain current, $V_{GS} = 10V$	I_D	$T_C = +25^\circ C$	55
		$T_C = +100^\circ C$	39
Pulsed drain current (10 μ s Pulse, Duty Cycle = 1%)	I_{DM}	58	A
Maximum Continuous Body Diode Forward Current (1)	I_S	2.2	A
Avalanche Current, L = 0. 1mH	I_{AS}	29	A
Avalanche Energy, L = 0. 1mH	E_{AS}	43	mJ
Power dissipation(1)	P_D	2.0	W
Power dissipation(2)		3.7	
Thermal resistance from Junction to ambient (1)	$R_{\theta JA}$	74	$^\circ C/W$
Thermal resistance from Junction to ambient (2)		40	
Thermal Resistance, Junction to Case (1)	$R_{\theta JC}$	1.2	$^\circ C/W$
Operating and Storage temperature	T_J, T_{STG}	-55 ~ +175	$^\circ C$

ELECTRICAL CHARACTERISTICS ($T_A = 25^\circ C$ unless otherwise specified)

Parameter	Symbol	Min	Typ	Max	Unit	Conditions
Drain-Source breakdown voltage(3)	$V_{(BR)DSS}$	100			V	$V_{GS}=0V, I_D=250\mu A$
Zero gate voltage drain current(3)	I_{DSS}			1	μA	$V_{DS}=100V, V_{GS}=0V$
Gate-body leakage current(3)	I_{GSS}			± 100	nA	$V_{DS}=0V, V_{GS}=\pm 20V$
Gate-threshold voltage (3)	$V_{GS(th)}$	2.0	2.5	3.3	V	$V_{DS}=V_{GS}, I_D=250\mu A$
Drain-source on-resistance (3)	$R_{DS(ON)}$		20	28	m Ω	$V_{GS}=10V, I_D=20A$
Diode forward voltage (3)	V_{SD}		0.7	1.2	V	$I_S=1.0A, V_{GS}=0V$
Input capacitance (4)	C_{iss}		2245		pF	$V_{DS}=50V, V_{GS}=0V, f=1MHz$
Output capacitance(4)	C_{oss}		173		pF	
Reverse transfer capacitance(4)	C_{rss}		68		pF	
Gate Resistance(4)	R_g		1.9		Ω	$V_{DS}=0V, V_{GS}=0V, f=1MHz$
Turn-on delay time(4)	$t_{d(on)}$		6.4		nS	$V_{DS}=50V, V_{GS}=10V$ $I_D=20A, R_g=3.0\Omega$
Turn-on rise time(4)	t_r		5.8		nS	
Turn-off delay time(4)	$t_{d(off)}$		17.8		nS	
Turn-off fall time(4)	t_f		4.8		nS	$V_{DS}=50V, V_{GS}=6V, I_D=20A$
Total Gate Charge(4)	Q_g		22		nC	
Total gate charge(4)	Q_g		36		nC	
Gate-source charge(4)	Q_{gs}		7.3		nC	$V_{DS}=50V, V_{GS}=10V, I_D=20A$
Gate-drain charge(4)	Q_{gd}		9.2		nC	
Body Diode Reverse Recovery Time(4)	t_{rr}		35		nS	$I_S=20A, di/dt= 100A/\mu s$
Body Diode Reverse Recovery Charge(4)	Q_{rr}		47		nC	

- Notes: 1. Device mounted on FR-4 substrate PC board, 2oz copper, with minimum recommended pad layout.
 2. Device mounted on FR-4 substrate PC board, 2oz copper, with 1inch square copper plate.
 3. Short duration pulse test used to minimize self-heating effect.
 4. Guaranteed by design. Not subject to product testing.

N-CHANNEL HIGH VOLTAGE MOSFET

Typical Characteristics

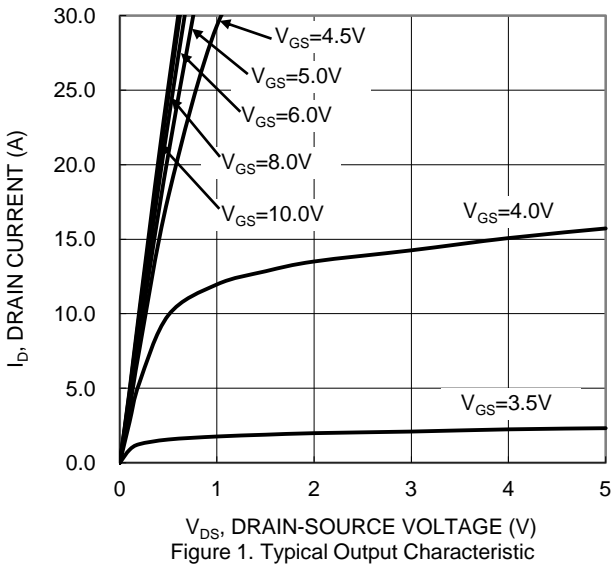

Figure 1. Typical Output Characteristic

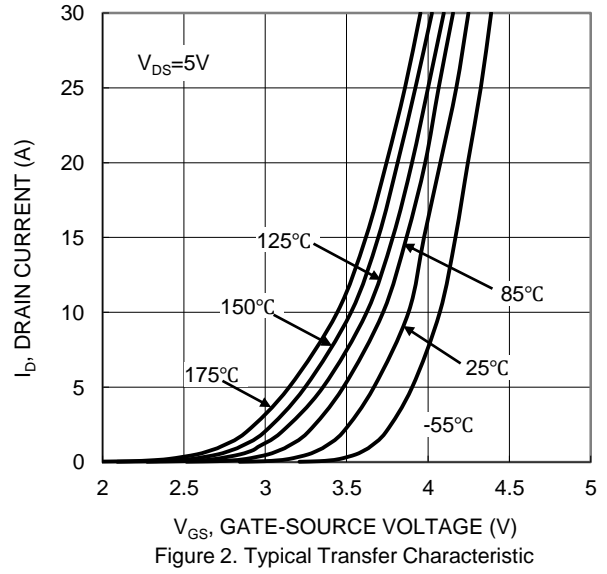

Figure 2. Typical Transfer Characteristic

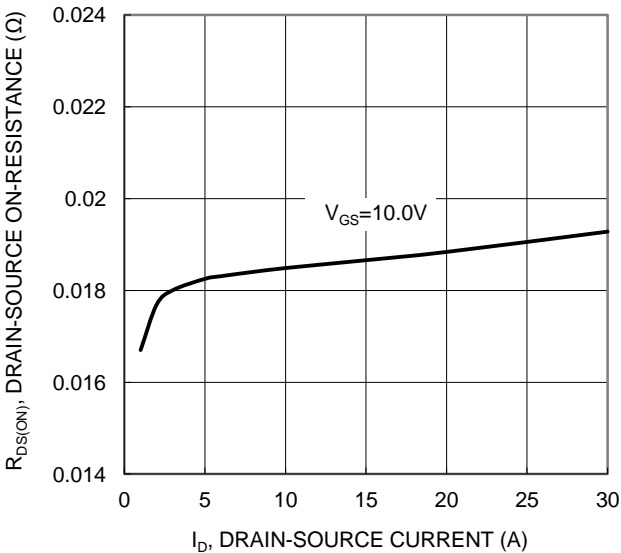

Figure 3. Typical On-Resistance vs. Drain Current and Gate Voltage

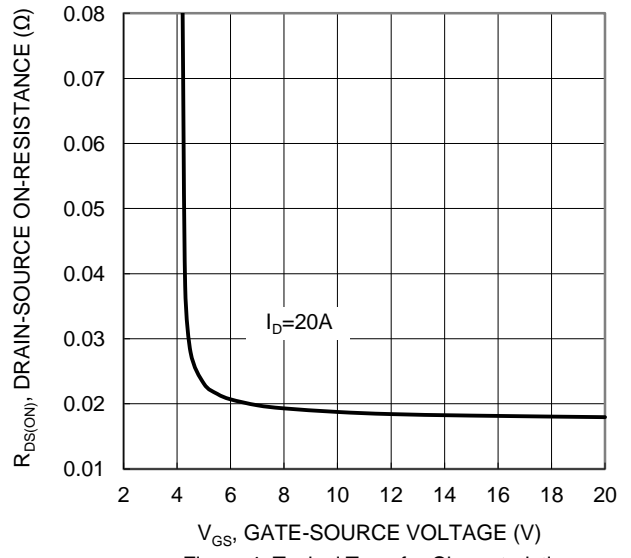

Figure 4. Typical Transfer Characteristic

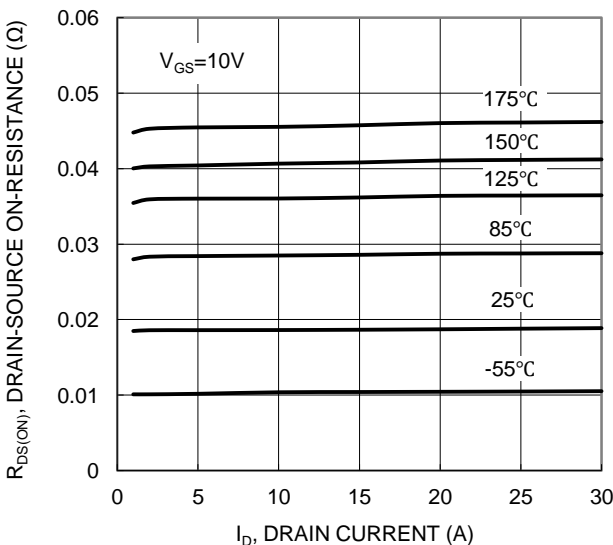

Figure 5. Typical On-Resistance vs. Drain Current and Temperature

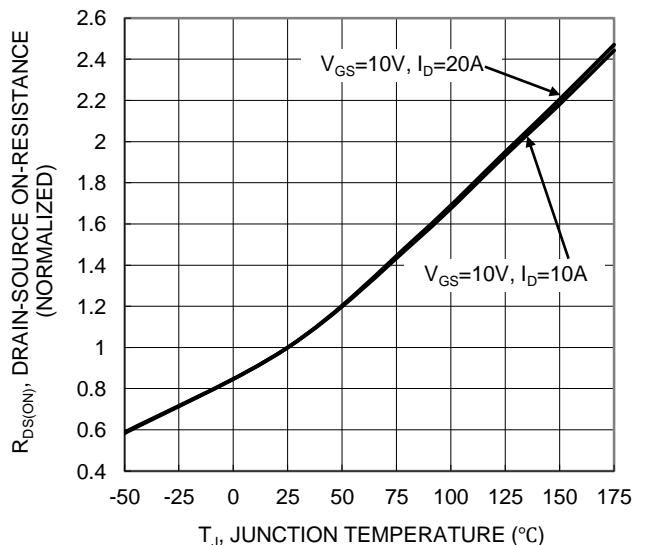

Figure 6. On-Resistance Variation with Temperature

N-CHANNEL HIGH VOLTAGE MOSFET

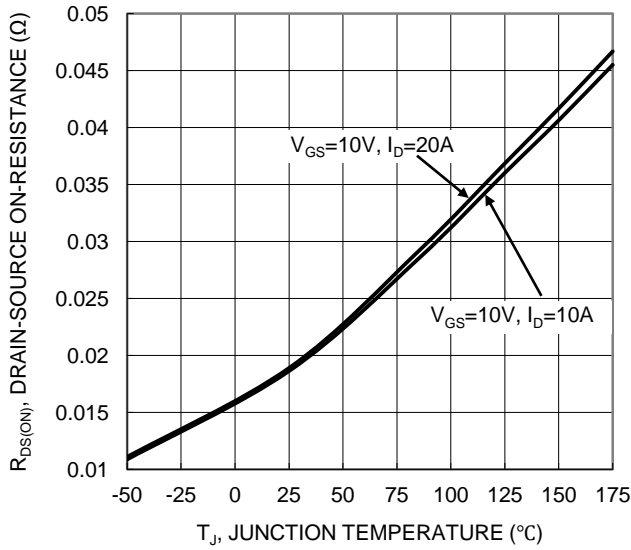

Figure 7. On-Resistance Variation with Temperature

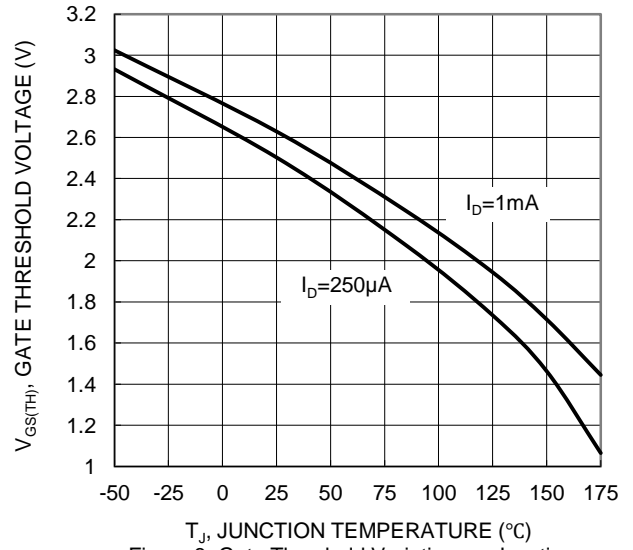

Figure 8. Gate Threshold Variation vs. Junction Temperature

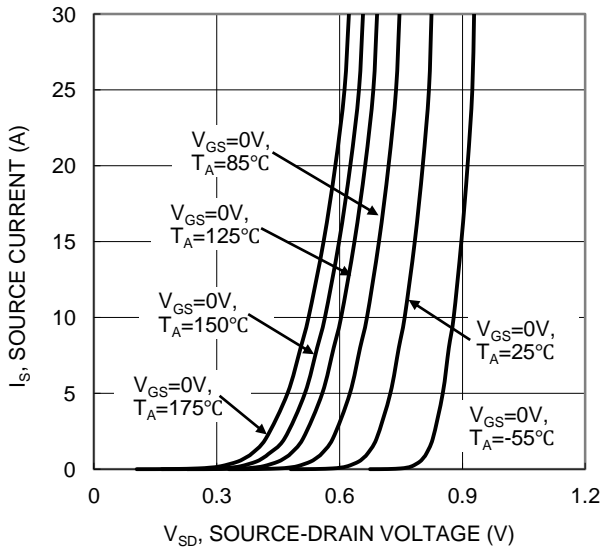

Figure 9. Diode Forward Voltage vs. Current

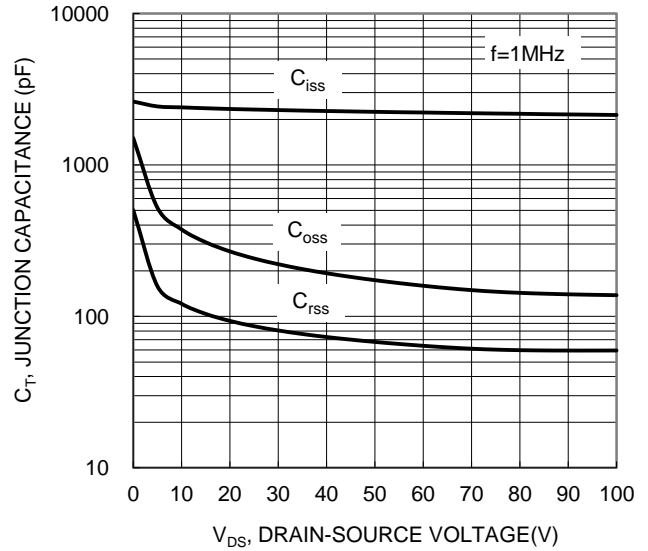

Figure 10. Typical Junction Capacitance

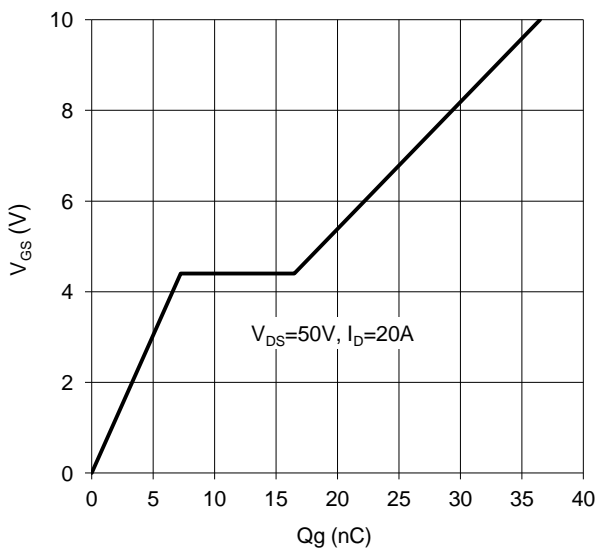

Figure 11. Gate Charge

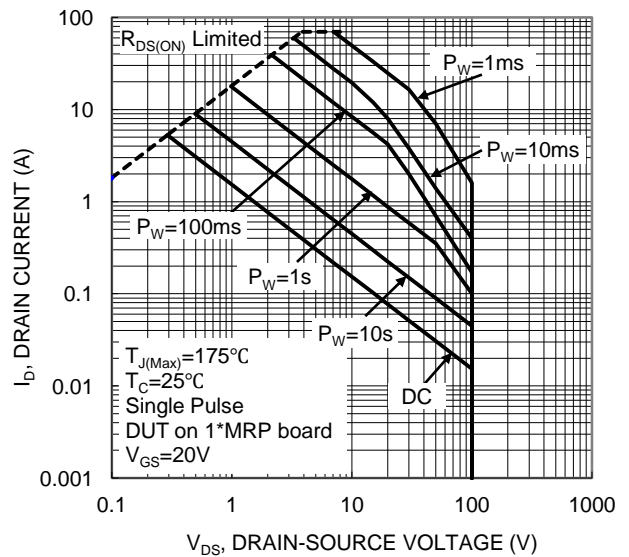

Figure 12. SOA, Safe Operation Area

N-CHANNEL HIGH VOLTAGE MOSFET

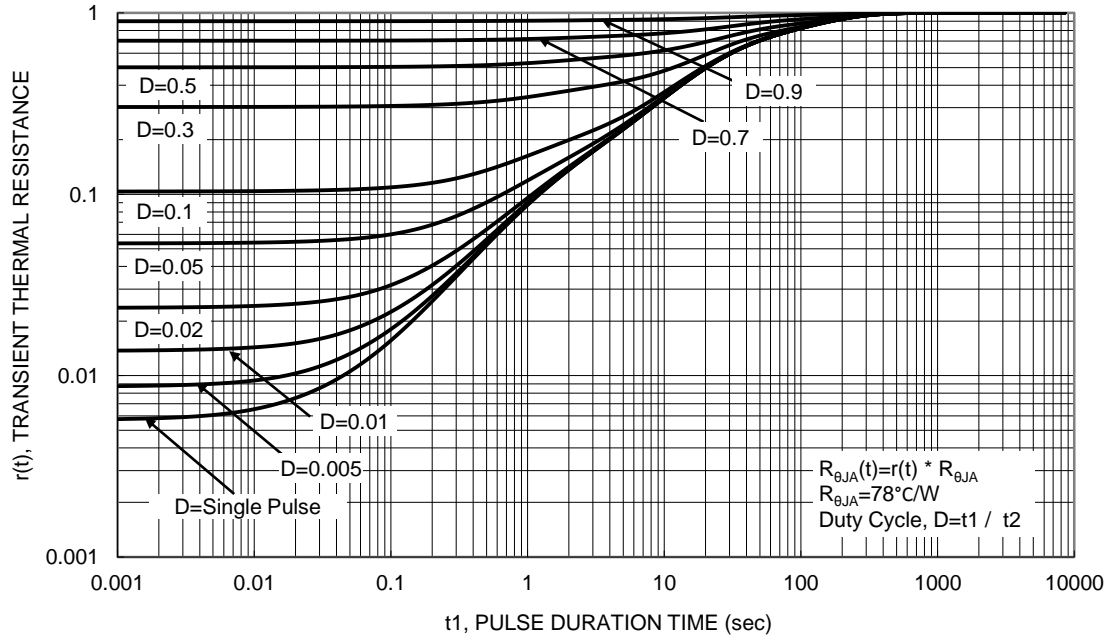
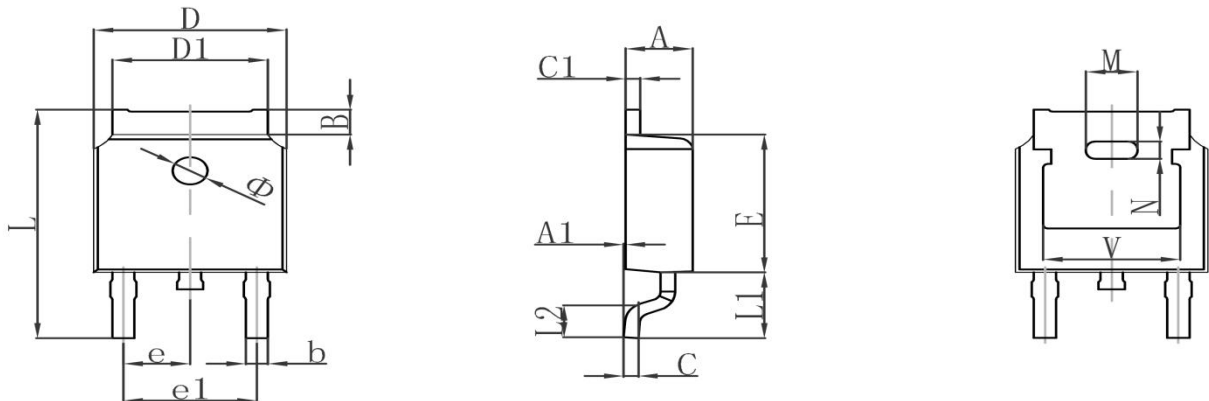
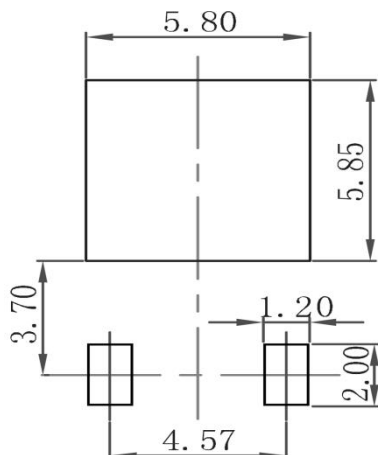

Figure 13. Transient Thermal Resistance

N-CHANNEL HIGH VOLTAGE MOSFET
TO-252 Package Outline Dimensions

Symbol	Dimensions In Millimeters		Dimensions In Inches	
	Min.	Max.	Min.	Max.
A	2.200	2.380	0.087	0.094
A1	0.000	0.100	0.000	0.004
B	0.800	1.400	0.031	0.055
b	0.710	0.810	0.028	0.032
c	0.460	0.560	0.018	0.022
c1	0.460	0.560	0.018	0.022
D	6.500	6.700	0.256	0.264
D1	5.130	5.460	0.202	0.215
E	6.000	6.200	0.236	0.244
e	2.286TYP		0.090TYP	
e1	4.327	4.727	0.170	0.186
M	1.778REF		0.070REF	
N	0.762REF		0.018REF	
L	9.800	10.400	0.386	0.409
L1	2.9REF		0.114REF	
L2	1.400	1.700	0.055	0.067
V	4.830REF		0.190REF	
Φ	1.100	1.300	0.043	0.051

TO-252 Suggested Pad Layout

Note:

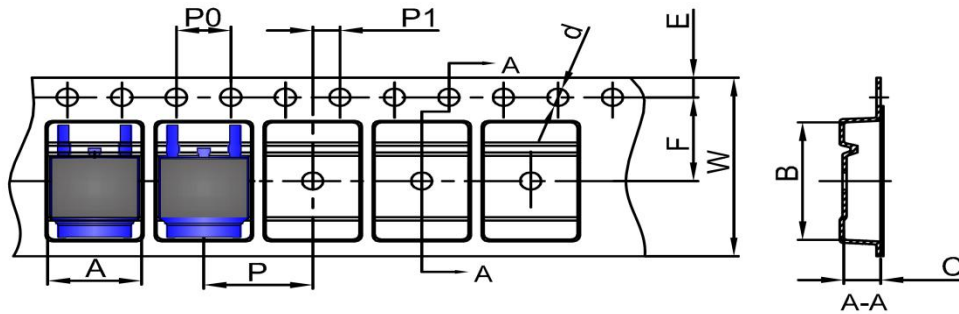
1. Controlling dimension: in millimeters
2. General tolerance: $\pm 0.05\text{mm}$
3. The pad layout is for reference purposes only

N-CHANNEL HIGH VOLTAGE MOSFET
TO-252 Tape and Reel
TO-252 Embossed Carrier Tape

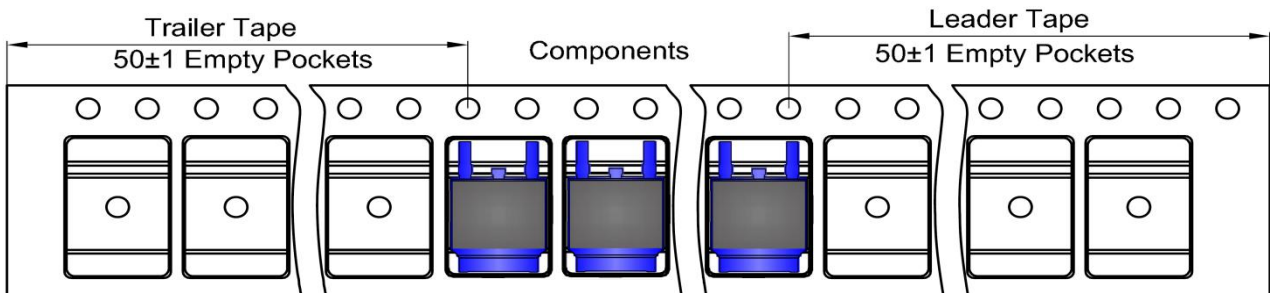
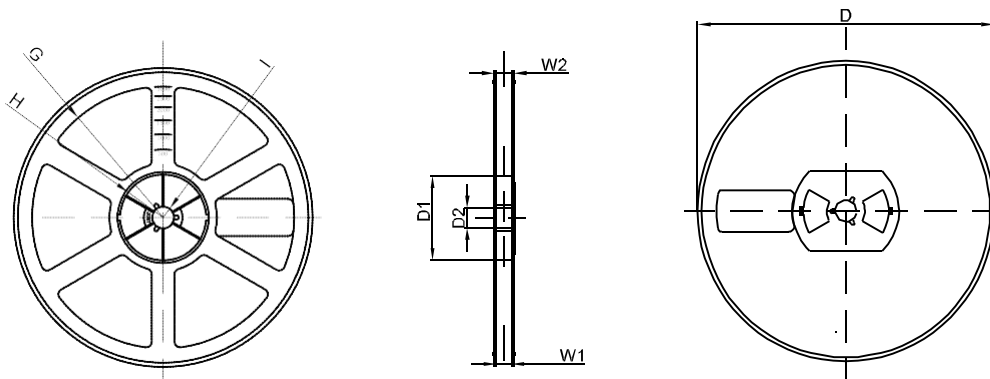
DIMENSIONS ARE IN MILLIMETER										
TYPE	A	B	C	d	E	F	P0	P	P1	W
TO-252	6.90	10.50	2.70	Ø1.55	1.75	7.50	4.00	8.00	2.00	16.00
TOLERANCE	±0.1	±0.1	±0.1	±0.1	±0.1	±0.1	±0.1	±0.1	±0.1	±0.1

TO-252 Tape Leader and Trailer

TO-252 Reel

DIMENSIONS ARE IN MILLIMETER								
REEL OPTION	D	D1	D2	G	H	I	W1	W2
13" DIA	Ø330.00	100.00	Φ21.00	R151.00	R56.00	R6.50	16.40	21.00
TOLERANCE	±2	±1	±1	±1	±1	±1	±1	±1