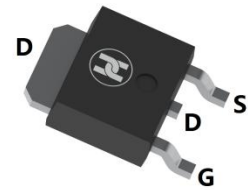
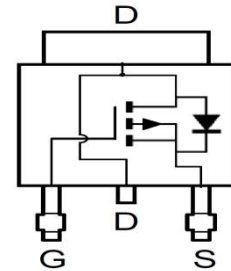

P-CHANNEL HIGH VOLTAGE MOSFET
FEATURES

- $V_{DS}=-100V, R_{DS(ON)}\leq 235m\Omega @ V_{GS}=-10V, I_D=-4.6A$
- Low On-Resistance and Fast switching speed
- Low threshold and Low gate drive
- For Power Management Functions and DC-DC Converters Applications
- For Disconnect switches and Motor control Applications
- Surface Mount device

TO-252

MECHANICAL DATA

- Case: TO-252(DPAK)
- Case Material: Molded Plastic. UL flammability
- Classification Rating: 94V-0
- Moisture Sensitivity: Level 1 per J-STD-020
- Weight: 0.33 grams (approximate)

MAXIMUM RATINGS ($T_A = 25^\circ C$ unless otherwise noted)

Parameter		Symbol	Value	Unit
Drain-source voltage		V_{DS}	-100	V
Gate-source voltage		V_{GS}	± 20	V
Continuous drain current, $V_{GS} = -10V$	$T_A = +25^\circ C$ (Note2)	I_D	-4.6	A
	$T_A = +100^\circ C$ (Note2)		-3.7	
	$T_A = +25^\circ C$ (Note1)		-3	
Pulsed drain current	(Note3)	I_{DM}	-15.4	A
Maximum Body Diode Forward Current	(Note2)	I_S	-10.6	A
Pulsed source current (body diode)	(Note3)	I_{SM}	-15.4	A
Power dissipation	$T_A = +25^\circ C$ (Note1)	P_D	4.24	W
	$T_A = +25^\circ C$ (Note2)		9.76	
	$T_A = +25^\circ C$ (Note4)		2.15	
Thermal resistance from Junction to ambient	(Note1)	$R_{\theta JA}$	29.45	$^\circ C/W$
	(Note2)		12.8	
	(Note4)		58.1	
Operating and Storage temperature		T_J, T_{STG}	-55 ~ +150	$^\circ C$

NOTES: (1) For a device surface mounted on 50mm x 50mm x 1.6mm FR4 PCB with high coverage of single sided 2oz copper, in still air conditions.

(2) For a device surface mounted on FR4 PCB measured at $t \leq 10$ sec.

(3) Repetitive rating 50mm x 50mm x 1.6mm FR4 PCB, $D=0.02$ pulse width=300 μs - pulse width limited by maximum junction temperature.

(4) For a device surface mounted on 25mm x 25mm x 1.6mm FR4 PCB with high coverage of single sided 1oz copper, in still air conditions.

P-CHANNEL HIGH VOLTAGE MOSFET
ELECTRICAL CHARACTERISTICS (T_A = 25°C unless otherwise specified)

Parameter	Symbol	Min	Typ	Max	Unit	Conditions
Static characteristics						
Drain-Source breakdown voltage	V _{(BR)DSS}	-100			V	V _{GS} =0V, I _D =-250μA
Zero gate voltage drain current	I _{DSS}			-1	μA	V _{DS} =-100V, V _{GS} =0V
Gate-body leakage current	I _{GSS}			±100	nA	V _{DS} =0V, V _{GS} =±20V
Gate-threshold voltage	V _{GS(th)}	-2.0		-4.0	V	V _{DS} =V _{GS} , I _D =-250μA
Drain-source on-resistance (Note5)	R _{DS(ON)}			235	mΩ	V _{GS} =-10V, I _D =-2.1A
				285	mΩ	V _{GS} =-6V, I _D =-1.9A
Forward trans-conductance(Note5&7)	g _{fs}		4.7		S	V _{DS} =-15V, I _D =-2.1A
Dynamic characteristics(Note7)						
Input capacitance	C _{iss}		717		pF	V _{DS} =-50V, V _{GS} =0V, f=1MHz
Output capacitance	C _{oss}		55.3		pF	
Reverse transfer capacitance)	C _{rss}		46.4		pF	
Switching characteristics (Note6&7)						
Turn-on delay time	t _{d(on)}		4.3		nS	V _{DD} =-50V, I _D =-1A, R _g =6.0Ω, V _{GS} =-10V
Turn-on rise time	t _r		5.2		nS	
Turn-off delay time	t _{d(off)}		20		nS	
Turn-off fall time	t _f		12.1		nS	
Total gate charge	Q _g		16.5		nC	V _{DS} =-50V, V _{GS} =-10V I _D =-2.1A
Gate-source charge	Q _{gs}		2.47		nC	
Gate-drain charge	Q _{gd}		5.36		nC	
Source-drain diode characteristics						
Diode forward voltage (Note5)	V _{SD}		-0.85	-0.95	V	I _S =-3.35A, V _{GS} =0V, T _J =25°C
Body Diode Reverse Recovery Time(Note7)	t _{rr}		43.3		nS	I _S =-2.4A, T _J =25°C
Body Diode Reverse Recovery Charge(Note7)	Q _{rr}		76.5		nC	di/dt= 100A/μs

Notes: 5. Measured under pulsed conditions. Pulse width≤300μs; duty cycle≤2%.

6. Switching characteristics are independent of operating junction temperature.

7. For design aid only, not subject to production testing.

P-CHANNEL HIGH VOLTAGE MOSFET

Typical Characteristics

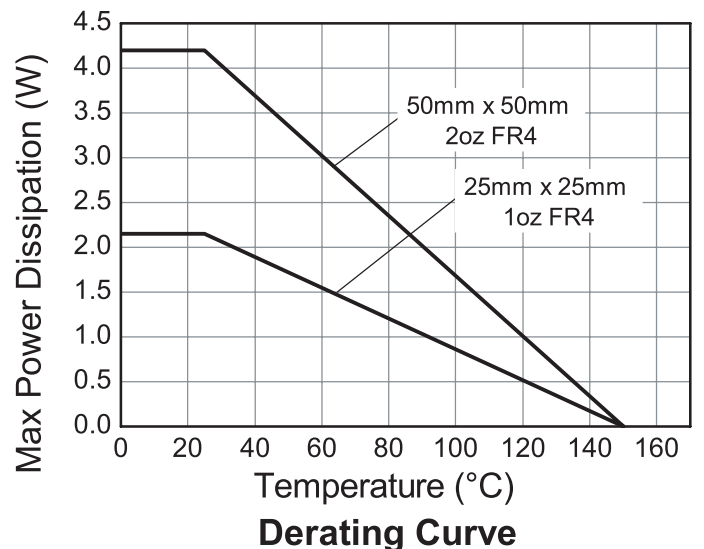
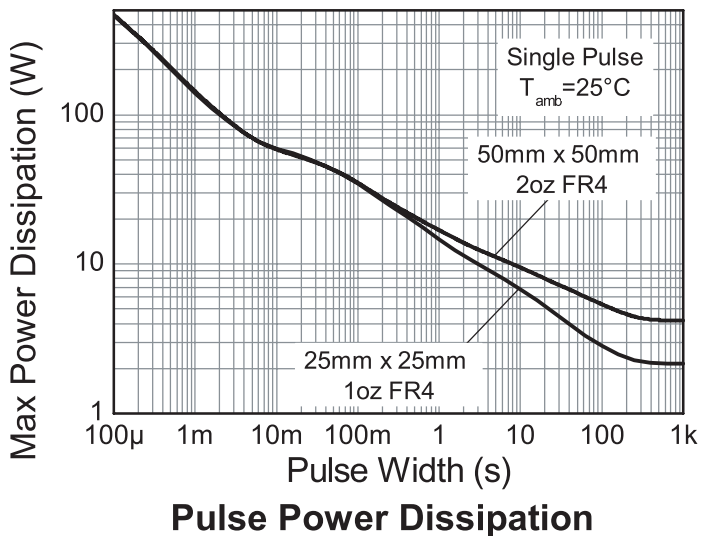
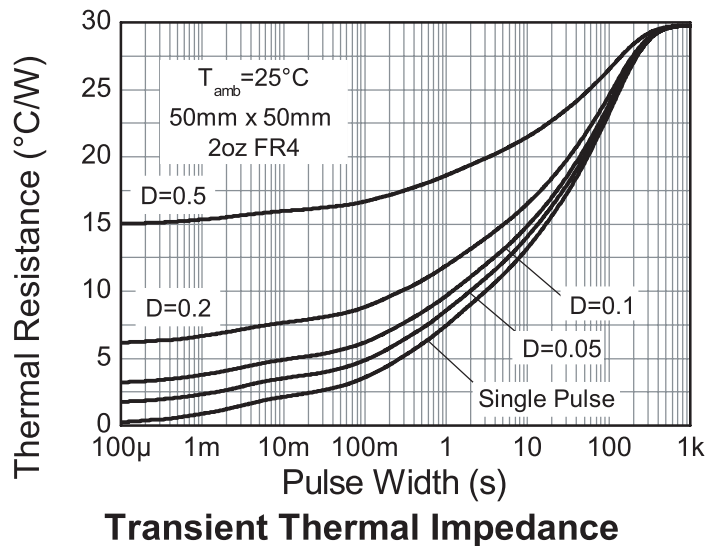
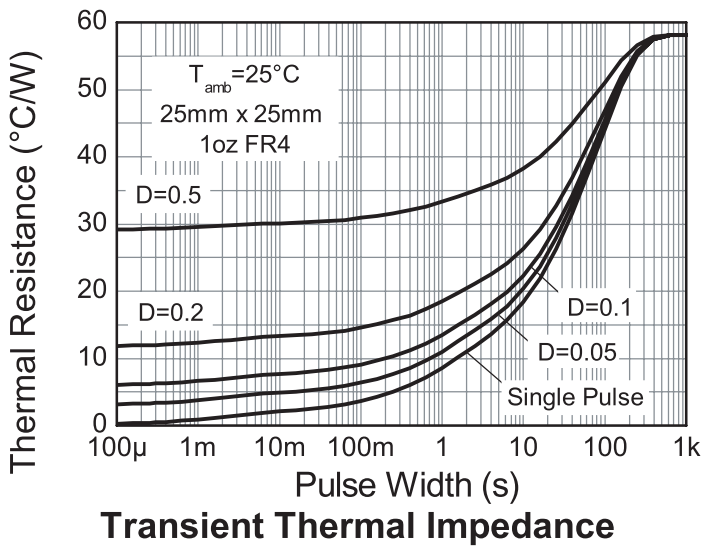
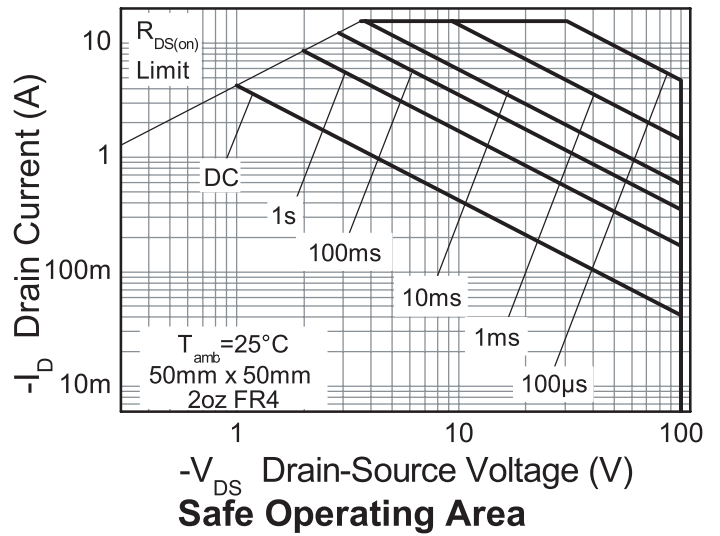
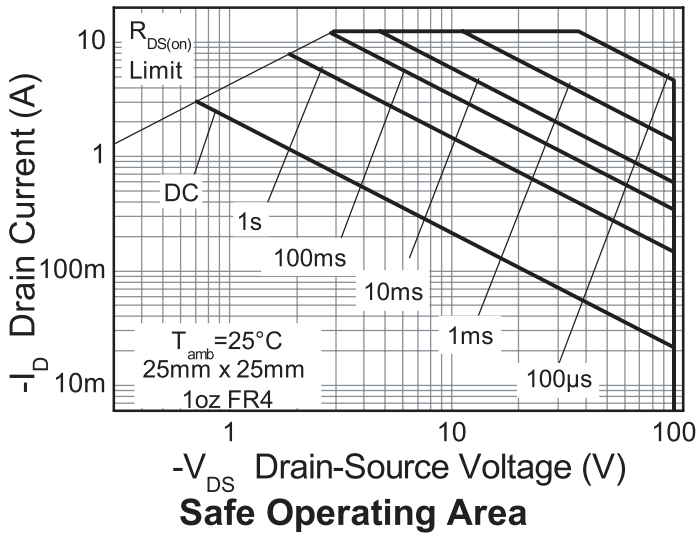

P-CHANNEL HIGH VOLTAGE MOSFET

Typical Characteristics

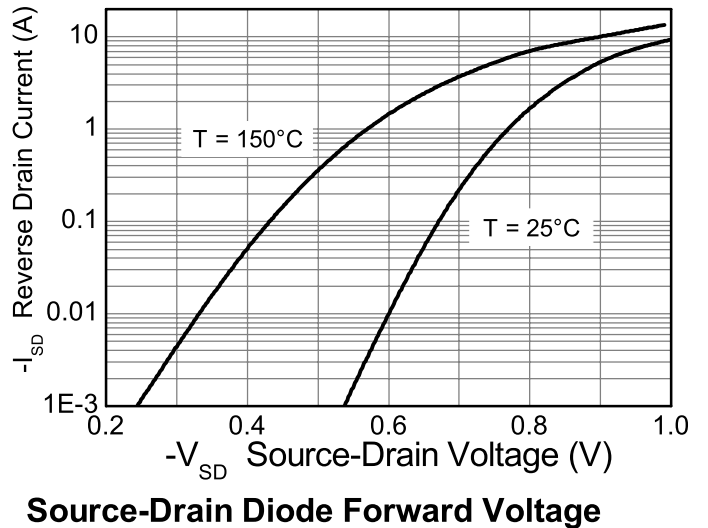
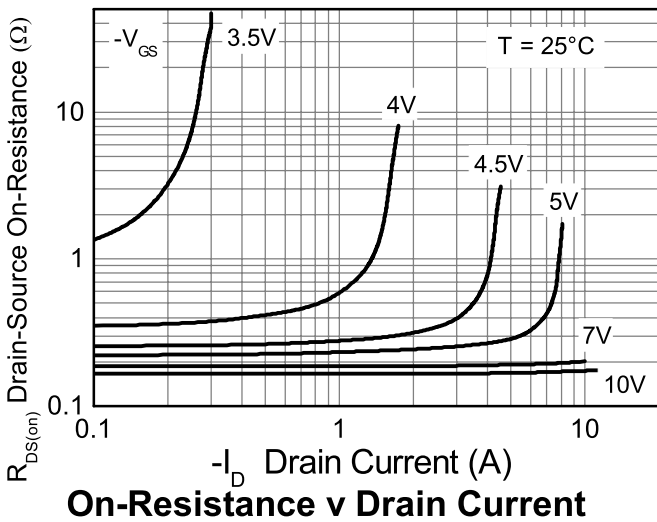
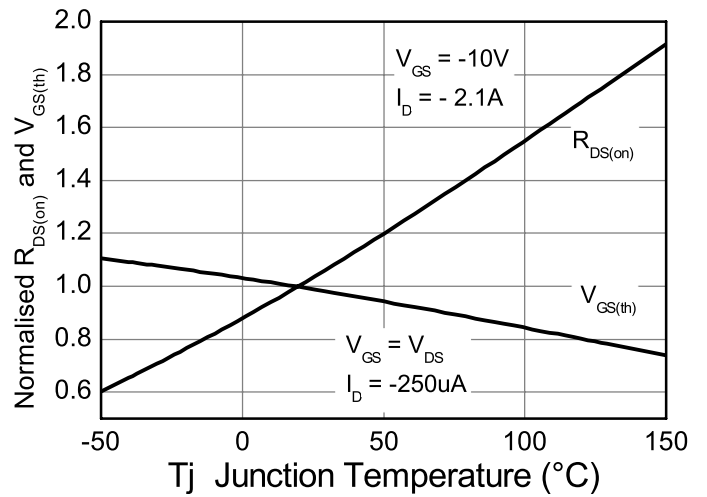
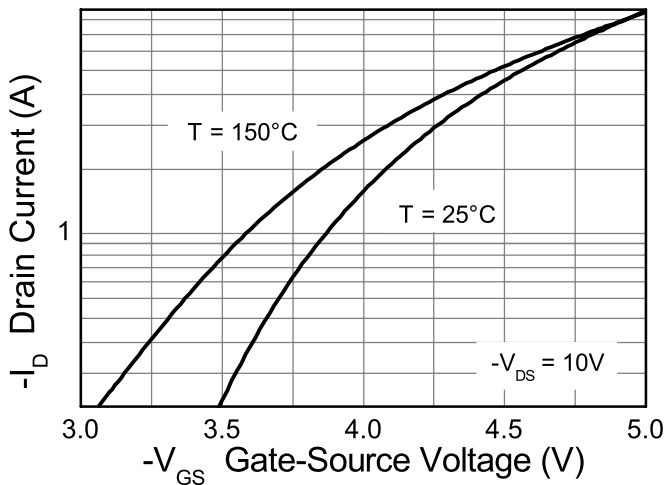
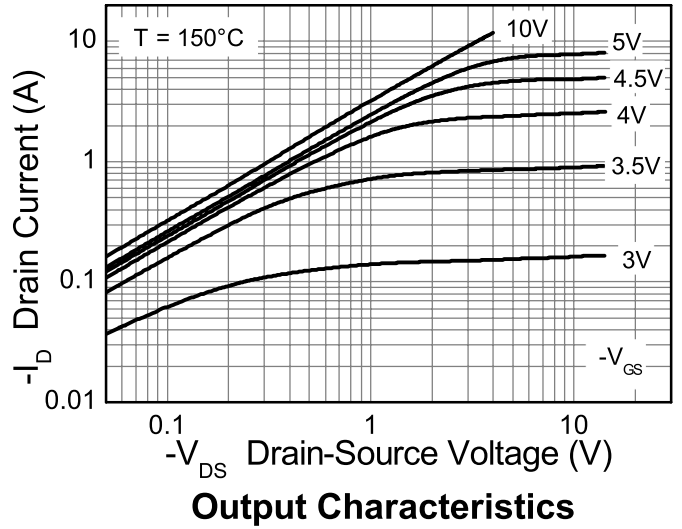
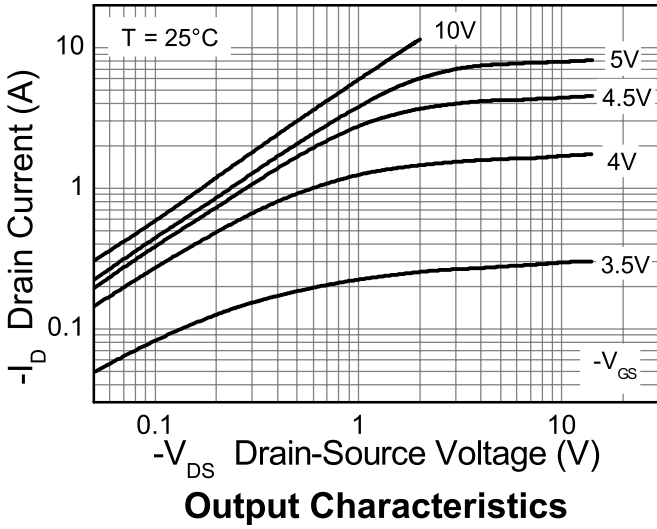

P-CHANNEL HIGH VOLTAGE MOSFET

Typical Characteristics

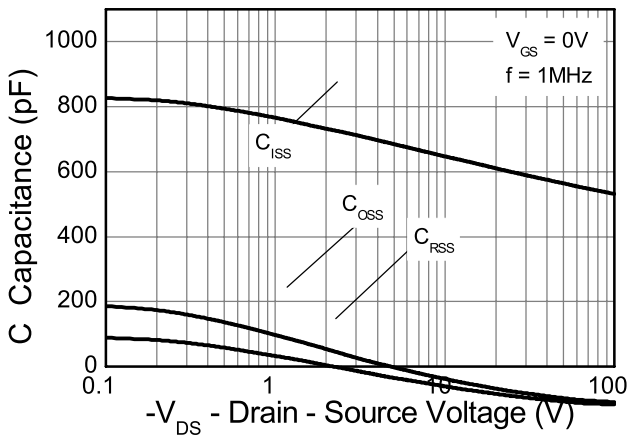

Capacitance v Drain-Source Voltage

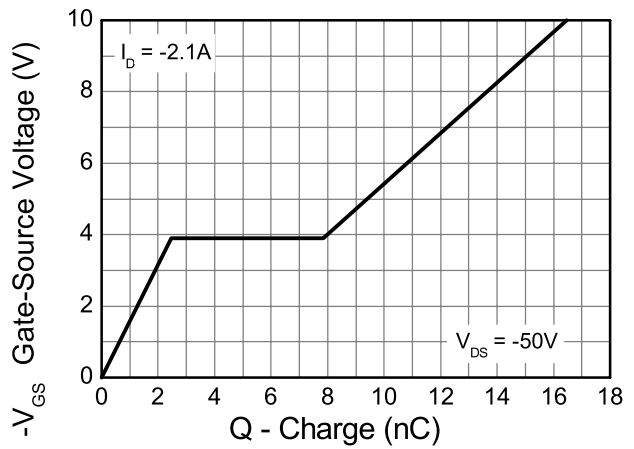

Gate-Source Voltage v Gate Charge

Test Circuit

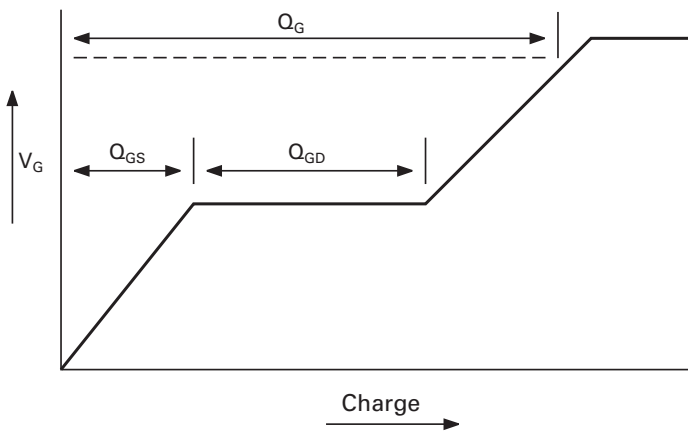

Basic gate charge waveform

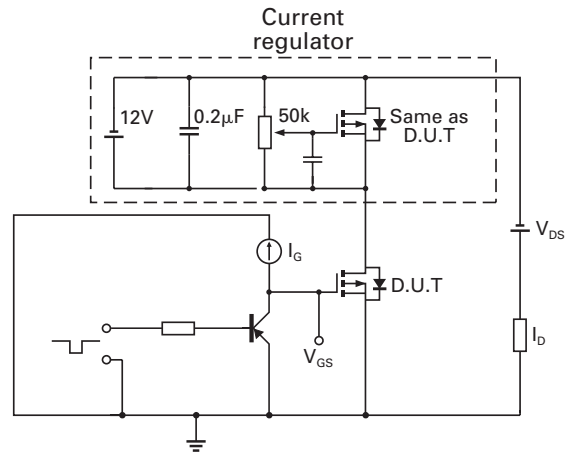

Gate charge test circuit

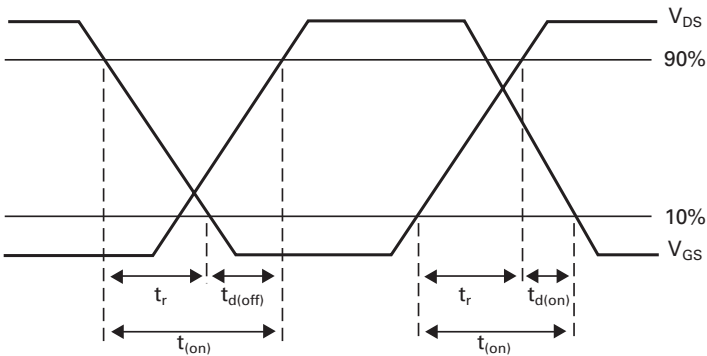

Switching time waveforms

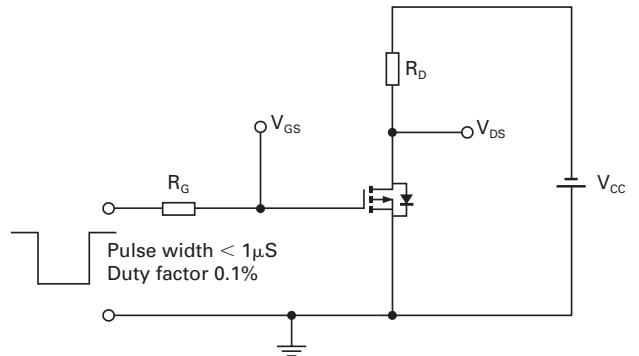

Switching time test circuit

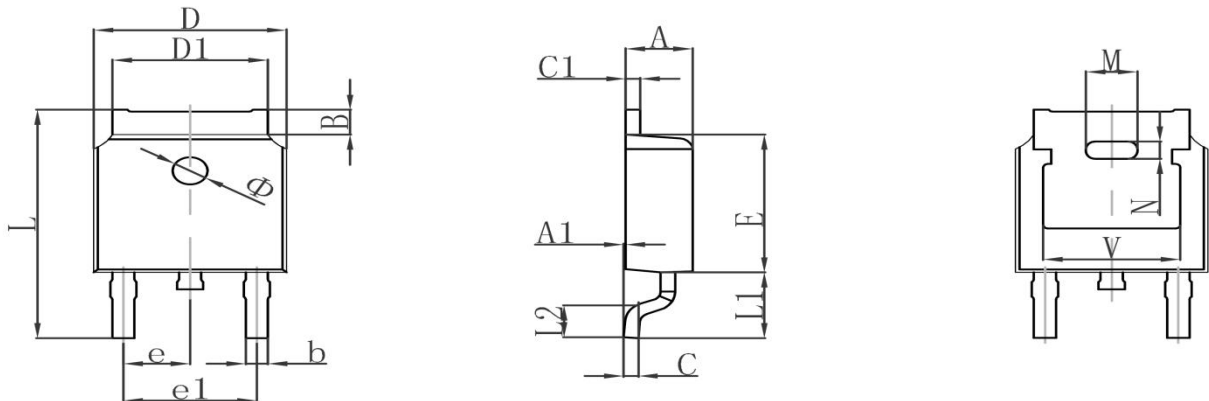
P-CHANNEL HIGH VOLTAGE MOSFET
TO-252 Package Outline Dimensions

Symbol	Dimensions In Millimeters		Dimensions In Inches	
	Min.	Max.	Min.	Max.
A	2.200	2.380	0.087	0.094
A1	0.000	0.100	0.000	0.004
B	0.800	1.400	0.031	0.055
b	0.710	0.810	0.028	0.032
c	0.460	0.560	0.018	0.022
c1	0.460	0.560	0.018	0.022
D	6.500	6.700	0.256	0.264
D1	5.130	5.460	0.202	0.215
E	6.000	6.200	0.236	0.244
e	2.286TYP		0.090TYP	
e1	4.327	4.727	0.170	0.186
M	1.778REF		0.070REF	
N	0.762REF		0.018REF	
L	9.800	10.400	0.386	0.409
L1	2.9REF		0.114REF	
L2	1.400	1.700	0.055	0.067
V	4.830REF		0.190REF	
Φ	1.100	1.300	0.043	0.051

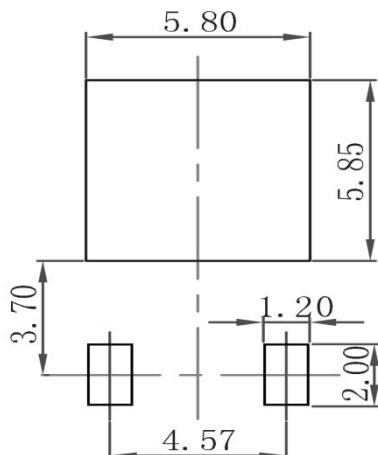
TO-252 Suggested Pad Layout

Note:

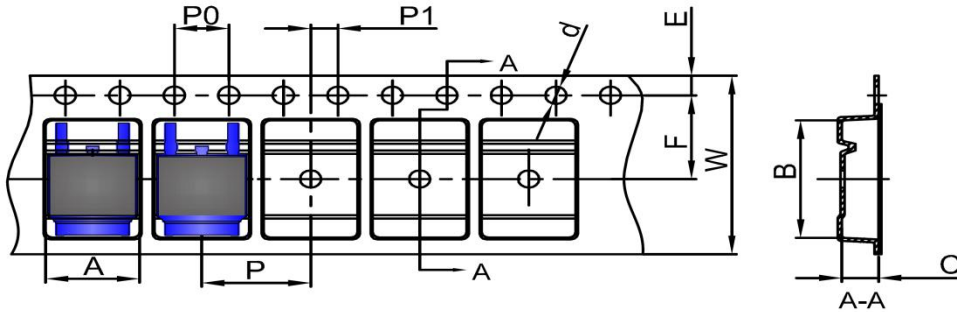
1. Controlling dimension: in millimeters
2. General tolerance: $\pm 0.05\text{mm}$
3. The pad layout is for reference purposes only

P-CHANNEL HIGH VOLTAGE MOSFET
TO-252 Tape and Reel
TO-252 Embossed Carrier Tape

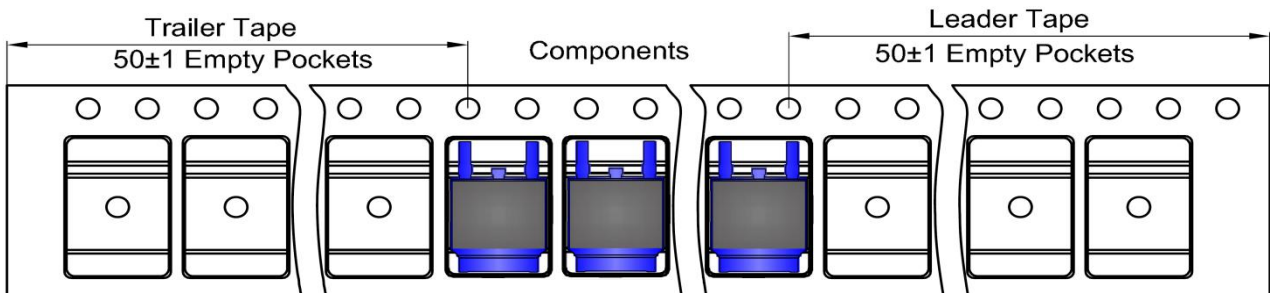
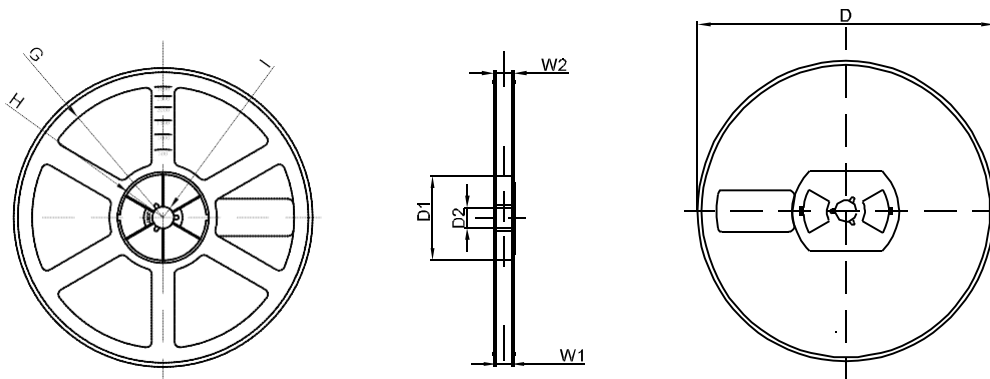
DIMENSIONS ARE IN MILLIMETER										
TYPE	A	B	C	d	E	F	P0	P	P1	W
TO-252	6.90	10.50	2.70	Ø1.55	1.75	7.50	4.00	8.00	2.00	16.00
TOLERANCE	±0.1	±0.1	±0.1	±0.1	±0.1	±0.1	±0.1	±0.1	±0.1	±0.1

TO-252 Tape Leader and Trailer

TO-252 Reel

DIMENSIONS ARE IN MILLIMETER								
REEL OPTION	D	D1	D2	G	H	I	W1	W2
13" DIA	Ø330.00	100.00	Φ21.00	R151.00	R56.00	R6.50	16.40	21.00
TOLERANCE	±2	±1	±1	±1	±1	±1	±1	±1