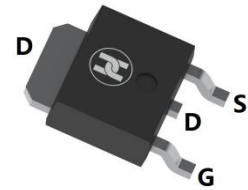
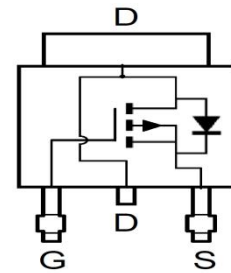

P-CHANNEL HIGH VOLTAGE MOSFET
FEATURES

- $V_{DS}=-100V, R_{DS(ON)} \leq 240m\Omega @ V_{GS}=-10V, I_D=-9A$
- Low On-Resistance
- Low Input Capacitance
- For Analog Switch and DC-DC Converters Applications
- For Power Management Functions Applications
- Surface Mount device

TO-252

MECHANICAL DATA

- Case: TO-252(DPAK)
- Case Material: Molded Plastic. UL flammability
- Classification Rating: 94V-0
- Moisture Sensitivity: Level 1 per J-STD-020
- Weight: 0.33 grams (approximate)

MAXIMUM RATINGS ($T_A = 25^\circ C$ unless otherwise noted)

Parameter	Symbol	Value	Unit
Drain-source voltage	V_{DS}	-100	V
Gate-source voltage	V_{GS}	± 20	V
Continuous drain current, $V_{GS} = -10V(1)$	I_D	$T_C = +25^\circ C$	-9
		$T_C = +100^\circ C$	-5.5
Pulsed drain current (10 μs Pulse, Duty Cycle = 1%)	I_{DM}	-15	A
Maximum Body Diode Forward Current (1)	I_S	-4	A
Power dissipation(1)	P_D	$T_C = +25^\circ C$	42
		$T_C = +100^\circ C$	17
Thermal resistance from Junction to ambient (1)	$R_{\theta JA}$	44	$^\circ C/W$
Thermal Resistance, Junction to Case (1)	$R_{\theta JC}$	3	$^\circ C/W$
Operating and Storage temperature	T_J, T_{STG}	-55 ~ +150	$^\circ C$

ELECTRICAL CHARACTERISTICS ($T_A = 25^\circ C$ unless otherwise specified)

Parameter	Symbol	Min	Typ	Max	Unit	Conditions
Drain-Source breakdown voltage(2)	$V_{(BR)DSS}$	-100			V	$V_{GS}=0V, I_D=-250\mu A$
Zero gate voltage drain current(2)	I_{DSS}			-1	μA	$V_{DS}=-80V, V_{GS}=0V$
Gate-body leakage current(2)	I_{GSS}			± 100	nA	$V_{DS}=0V, V_{GS}=\pm 20V$
Gate-threshold voltage (2)	$V_{GS(th)}$	-1.0		-3.0	V	$V_{DS}=V_{GS}, I_D=-250\mu A$
Drain-source on-resistance (2)	$R_{DS(ON)}$		190		m Ω	$V_{GS}=-10V, I_D=-5A$
			210		m Ω	$V_{GS}=-4.5V, I_D=-5A$
Diode forward voltage (2)	V_{SD}		-0.7		V	$I_S=-5A, V_{GS}=0V$
Input capacitance (3)	C_{iss}		1239		pF	$V_{DS}=-25V, V_{GS}=0V, f=1MHz$
Output capacitance(3)	C_{oss}		42		pF	
Reverse transfer capacitance(3)	C_{rss}		28		pF	
Gate Resistance(3)	R_g		13		Ω	$V_{DS}=0V, V_{GS}=0V, f=1MHz$
Turn-on delay time(3)	$t_{d(on)}$		9.1		nS	$V_{DD}=-50V, I_D=-5A, R_g=9.1\Omega$
Turn-on rise time(3)	t_r		14.9		nS	
Turn-off delay time(3)	$t_{d(off)}$		57.4		nS	
Turn-off fall time(3)	t_f		34.4		nS	
Total Gate Charge(3)	Q_g		8.4		nC	$V_{DS}=-60V, V_{GS}=-4.5V, I_D=-5A$
Total gate charge(3)	Q_g		17.5		nC	$V_{DD}=-60V, V_{GS}=-10V, I_D=-5A$
Gate-source charge(3)	Q_{gs}		2.8		nC	
Gate-drain charge(3)	Q_{gd}		3.2		nC	
Body Diode Reverse Recovery Time(3)	t_{rr}		25.2		nS	$V_{GS}=0V, I_S=-5A,$
Body Diode Reverse Recovery Charge(3)	Q_{rr}		24.5		nC	$dI/dt= 100A/\mu s$

Notes:1. Device mounted on FR-4 substrate PC board, 2oz copper, with 1inch square copper plate.

2. Short duration pulse test used to minimize self-heating effect.

3. Guaranteed by design. Not subject to production testing.

P-CHANNEL HIGH VOLTAGE MOSFET

Typical Characteristics

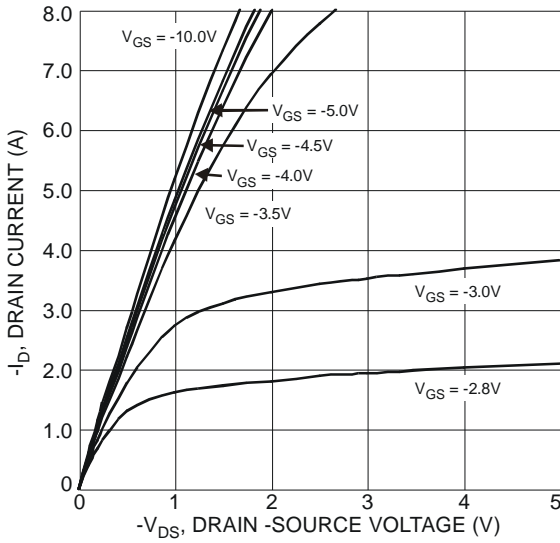

Fig. 1 Typical Output Characteristics

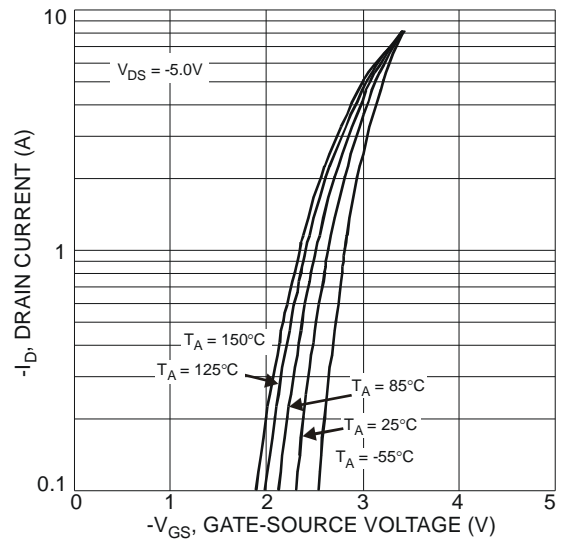

Fig. 2 Typical Transfer Characteristics

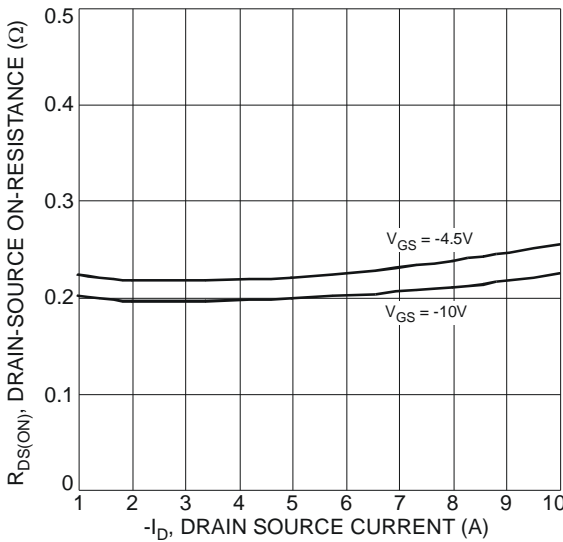

Fig. 3 Typical On-Resistance vs. Drain Current and Gate Voltage

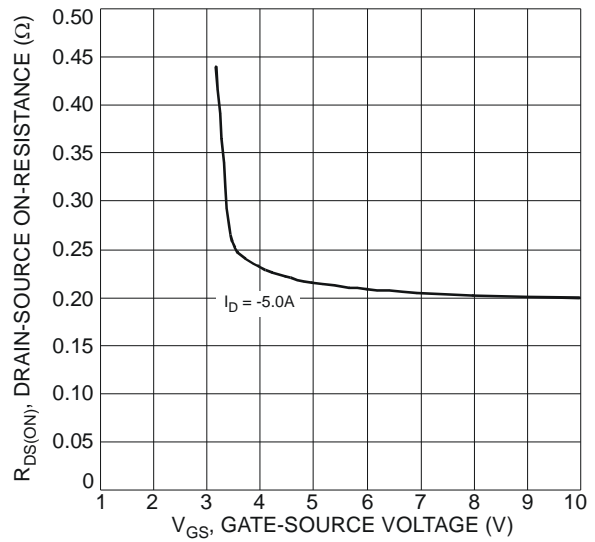

Fig. 4 Typical Drain-Source On-Resistance vs. Gate-Source Voltage

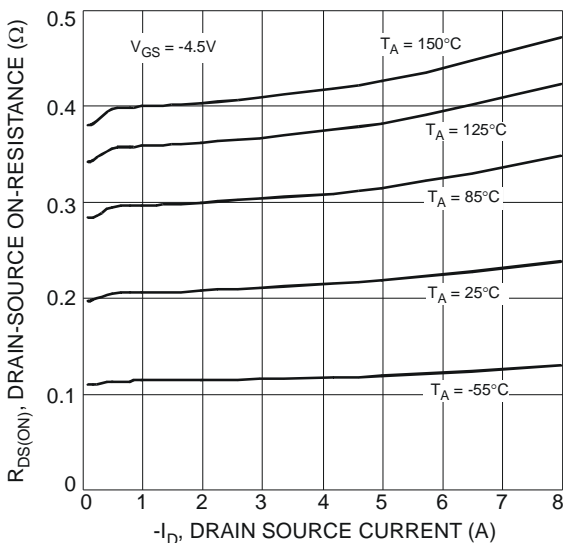

Fig. 5 Typical On-Resistance vs. Drain Current and Temperature

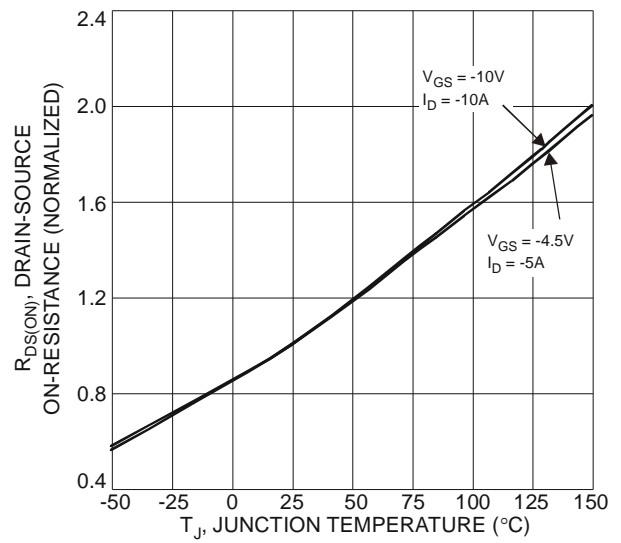

Fig. 6 On-Resistance Variation with Temperature

P-CHANNEL HIGH VOLTAGE MOSFET

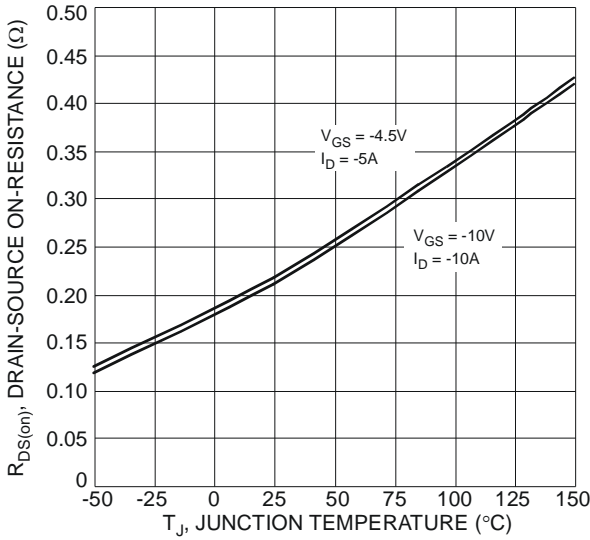

Fig. 7 On-Resistance Variation with Temperature

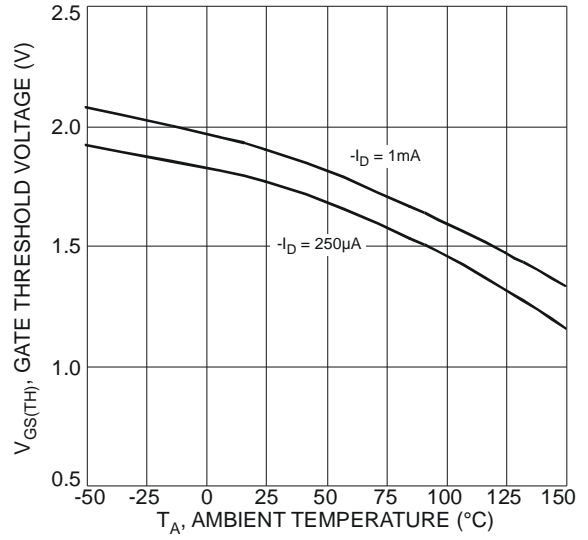

Fig. 8 Gate Threshold Variation vs. Ambient Temperature

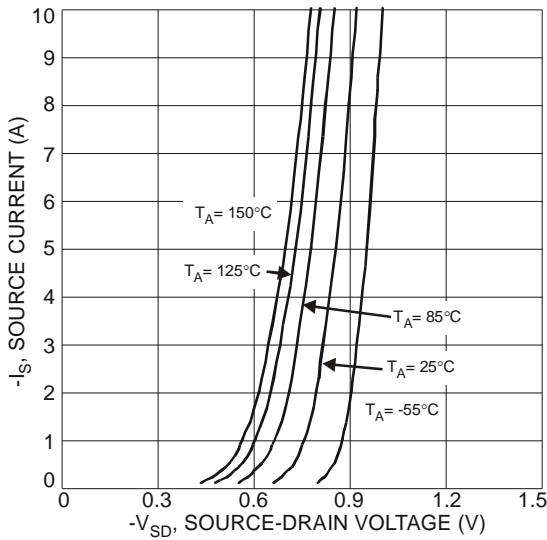

Fig. 9 Diode Forward Voltage vs. Current

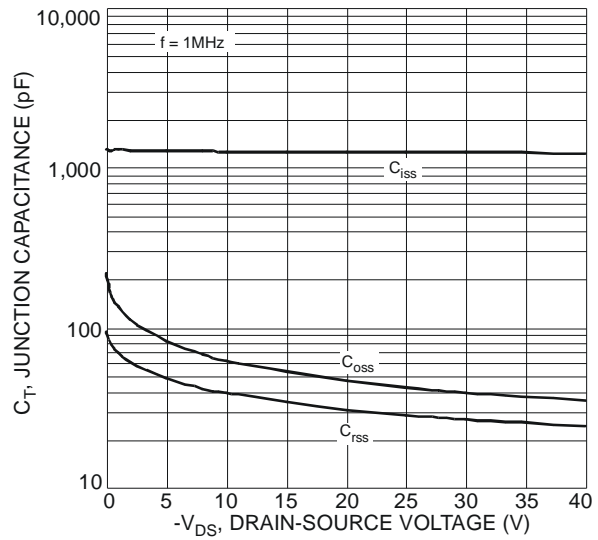

Fig. 10 Typical Junction Capacitance

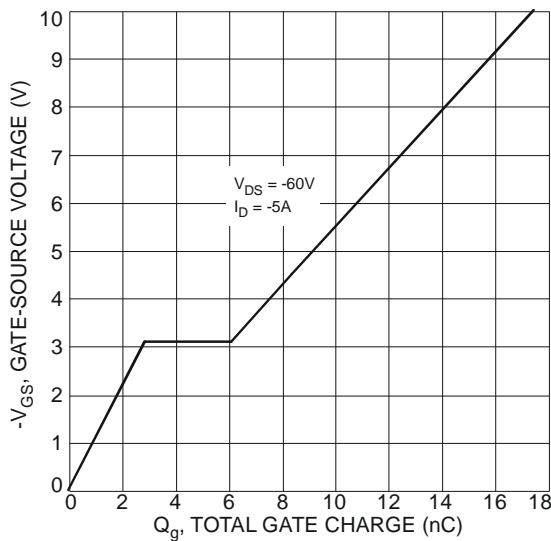

Fig. 11 Gate-Charge Characteristics

P-CHANNEL HIGH VOLTAGE MOSFET

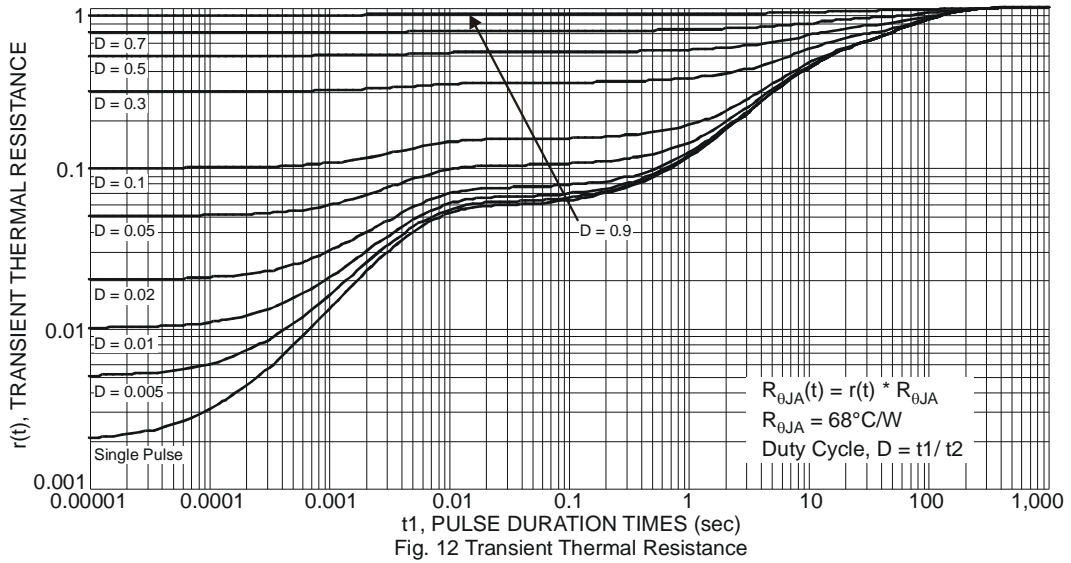
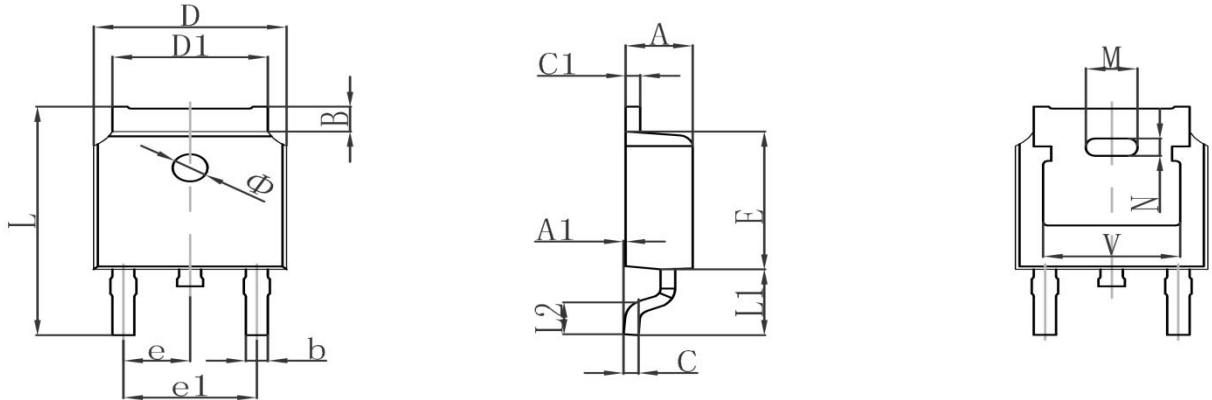
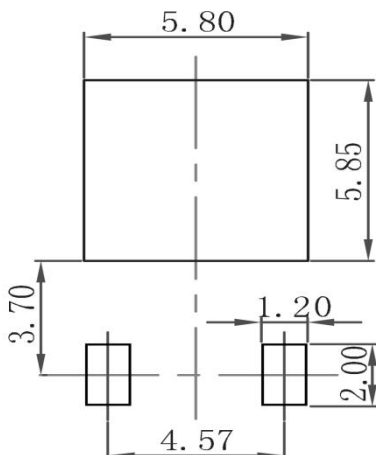

Fig. 12 Transient Thermal Resistance

P-CHANNEL HIGH VOLTAGE MOSFET
TO-252 Package Outline Dimensions

Symbol	Dimensions In Millimeters		Dimensions In Inches	
	Min.	Max.	Min.	Max.
A	2.200	2.380	0.087	0.094
A1	0.000	0.100	0.000	0.004
B	0.800	1.400	0.031	0.055
b	0.710	0.810	0.028	0.032
c	0.460	0.560	0.018	0.022
c1	0.460	0.560	0.018	0.022
D	6.500	6.700	0.256	0.264
D1	5.130	5.460	0.202	0.215
E	6.000	6.200	0.236	0.244
e	2.286TYP		0.090TYP	
e1	4.327	4.727	0.170	0.186
M	1.778REF		0.070REF	
N	0.762REF		0.018REF	
L	9.800	10.400	0.386	0.409
L1	2.9REF		0.114REF	
L2	1.400	1.700	0.055	0.067
V	4.830REF		0.190REF	
Φ	1.100	1.300	0.043	0.051

TO-252 Suggested Pad Layout

Note:

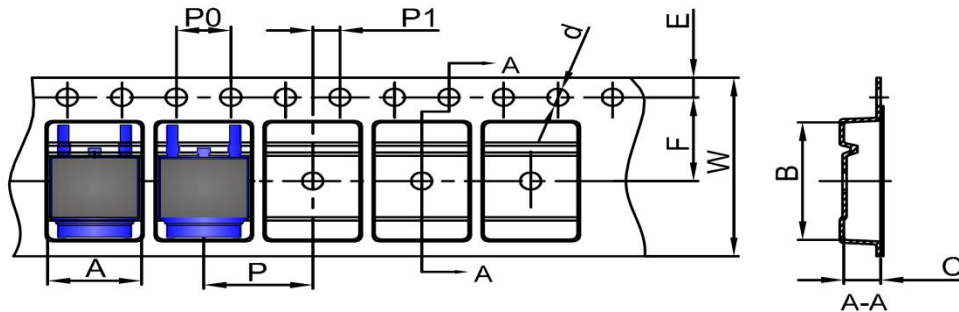
1. Controlling dimension: in millimeters
2. General tolerance: $\pm 0.05\text{mm}$
3. The pad layout is for reference purposes only

P-CHANNEL HIGH VOLTAGE MOSFET
TO-252 Tape and Reel
TO-252 Embossed Carrier Tape

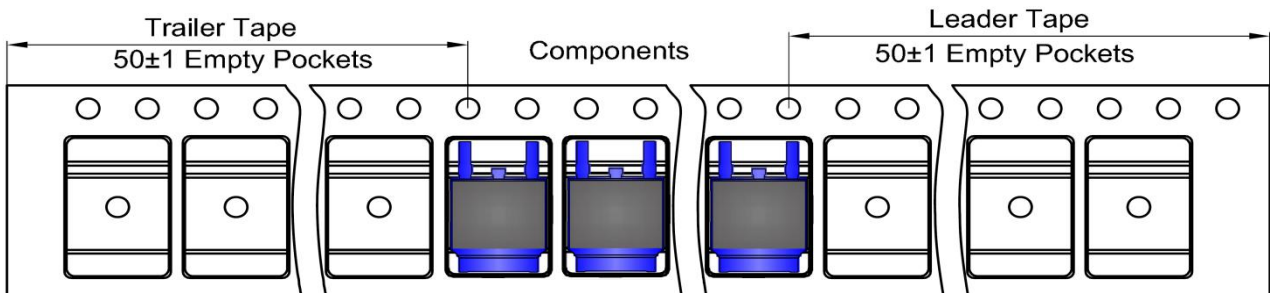
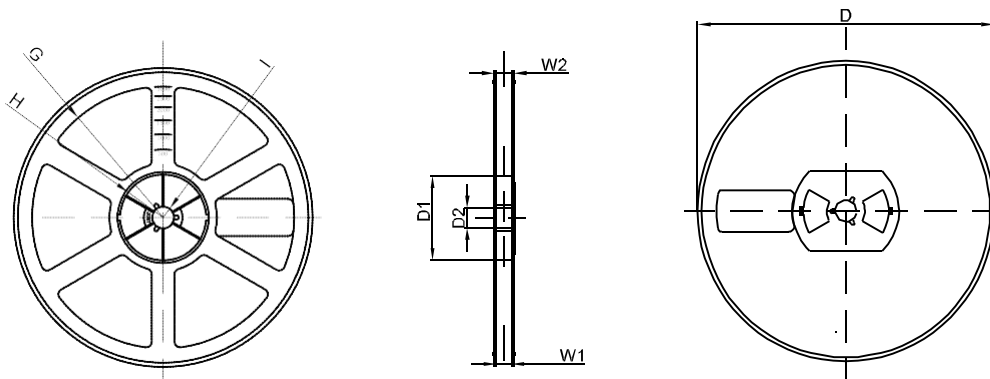
DIMENSIONS ARE IN MILLIMETER										
TYPE	A	B	C	d	E	F	P0	P	P1	W
TO-252	6.90	10.50	2.70	Ø1.55	1.75	7.50	4.00	8.00	2.00	16.00
TOLERANCE	±0.1	±0.1	±0.1	±0.1	±0.1	±0.1	±0.1	±0.1	±0.1	±0.1

TO-252 Tape Leader and Trailer

TO-252 Reel

DIMENSIONS ARE IN MILLIMETER								
REEL OPTION	D	D1	D2	G	H	I	W1	W2
13" DIA	Ø330.00	100.00	Φ21.00	R151.00	R56.00	R6.50	16.40	21.00
TOLERANCE	±2	±1	±1	±1	±1	±1	±1	±1