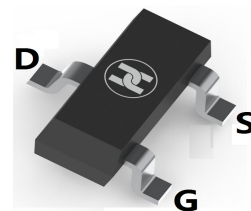
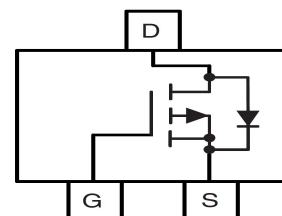

**LOW VOLTAGE MOSFET (P-CHANNEL)**
**FEATURES**

- $V_{DS}=-30V, R_{DS(ON)} \leq 190m\Omega @ V_{GS}=-10V, I_D=-1.9A$
- Low on-resistance
- For Low power DC to DC converter and Load switch applications
- Surface Mount device

**SOT-23**

**MECHANICAL DATA**

- Case: SOT-23
- Case Material: Molded Plastic. UL flammability
- Classification Rating: 94V-0
- Moisture Sensitivity: Level 1 per J-STD-020
- Weight: 0.008 grams (approximate)

**MAXIMUM RATINGS ( $T_A = 25^\circ\text{C}$  unless otherwise noted)**

Parameter	Symbol	Value	Unit
Drain-source voltage	$V_{DS}$	-30	V
Gate-source voltage	$V_{GS}$	$\pm 20$	V
Continuous drain current	$I_D$	-1.9	A
Continuous source-drain diode current	$I_S$	-0.83	A
Power dissipation	$P_D$	0.35	W
Thermal resistance from Junction to ambient	$R_{\theta JA}$	357	$^\circ\text{C/W}$
Junction temperature	$T_J$	150	$^\circ\text{C}$
Storage temperature	$T_{STG}$	-55 ~ +150	$^\circ\text{C}$

**ELECTRICAL CHARACTERISTICS ( $T_A = 25^\circ\text{C}$  unless otherwise specified)**

Parameter	Symbol	Min	Typ	Max	Unit	Conditions
Drain-Source breakdown voltage	$V_{(BR)DSS}$	-30			V	$V_{GS}=0V, I_D=-250\mu A$
Zero gate voltage drain current	$I_{DSS}$			-1	$\mu A$	$V_{DS}=-30V, V_{GS}=0V$
Gate-body leakage current	$I_{GSS}$			$\pm 100$	nA	$V_{DS}=0V, V_{GS}=\pm 20V$
Gate-threshold voltage (note 1)	$V_{GS(th)}$	-1	-1.6	-3	V	$V_{DS}=V_{GS}, I_D=-250\mu A$
Drain-source on-resistance (note 1)	$R_{DS(ON)}$		75	190	m $\Omega$	$V_{GS}=-10V, I_D=-1.9A$
			115	330	m $\Omega$	$V_{GS}=-4.5V, I_D=-1.4A$
Forward transconductance (note 1)	$g_{FS}$	1			S	$V_{DS}=-5V, I_D=-1.9A$
Gate resistance	$R_g$	1.7	8.5	17	$\Omega$	$f=1\text{MHz}$
Input capacitance	$C_{iss}$		155		pF	$V_{DS}=-15V, V_{GS}=0V, f=1\text{MHz}$
Output capacitance	$C_{oss}$		35		pF	
Reverse transfer capacitance	$C_{rss}$		25		pF	
Turn-on delay time	$t_{d(on)}$		4	8	nS	$V_{DD}=-15V, I_D=-1.5A, V_{GEN}=-10V, R_g=1\Omega, R_L=10\Omega$
Turn-on rise time	$t_r$		11	18	nS	
Turn-off delay time	$t_{d(off)}$		11	18	nS	
Turn-off fall time	$t_f$		8	16	nS	
Turn-on delay time	$t_{d(on)}$		36	44	nS	$V_{DD}=-15V, I_D=-1.5A, V_{GEN}=-4.5V, R_g=1\Omega, R_L=10\Omega$
Turn-on rise time	$t_r$		37	45	nS	
Turn-off delay time	$t_{d(off)}$		12	18	nS	
Turn-off fall time	$t_f$		9	14	nS	
Total gate charge	$Q_g$		4	8	nC	$V_{DD}=-15V, V_{GS}=-10V, I_D=-1.9A$
			2	4	nC	
Gate-source charge	$Q_{gs}$		0.6		nC	$V_{DD}=-15V, V_{GS}=-4.5V, I_D=-1.9A$
Gate-drain charge	$Q_{gd}$		1		nC	
Diode forward voltage (note 1)	$V_{SD}$		-0.8	-1.2	V	$I_S=-1.5A, V_{GS}=0V$
Diode forward current	$I_S$			-1.3	A	$T_C = 25^\circ\text{C}$
Pulse diode forward current	$I_{SM}$			-10	A	

Note:1. Pulse test ; Pulse width  $\leq 300\mu s$ , Duty cycle  $\leq 2\%$  .

**LOW VOLTAGE MOSFET (P-CHANNEL)**

**Typical Characteristics**

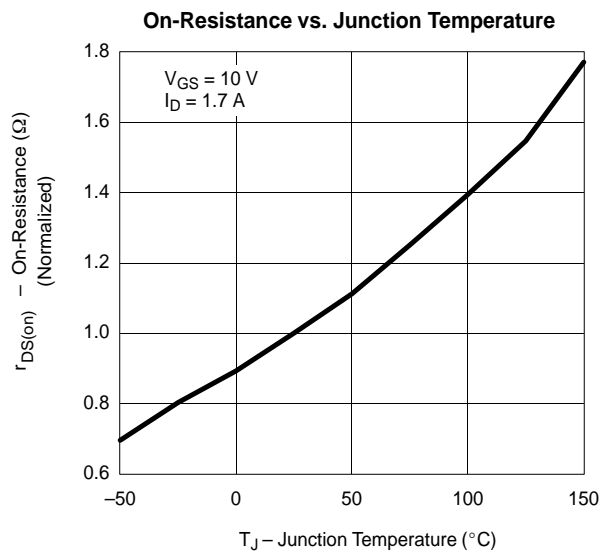
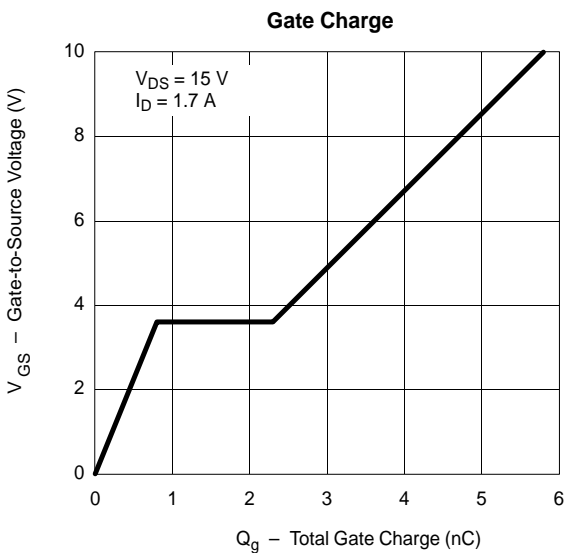
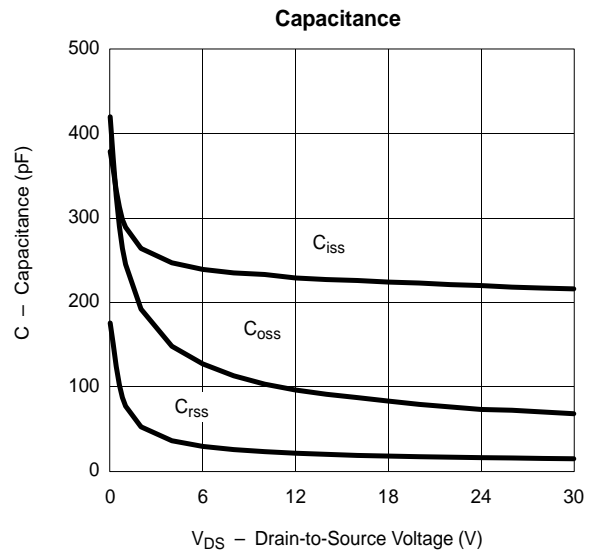
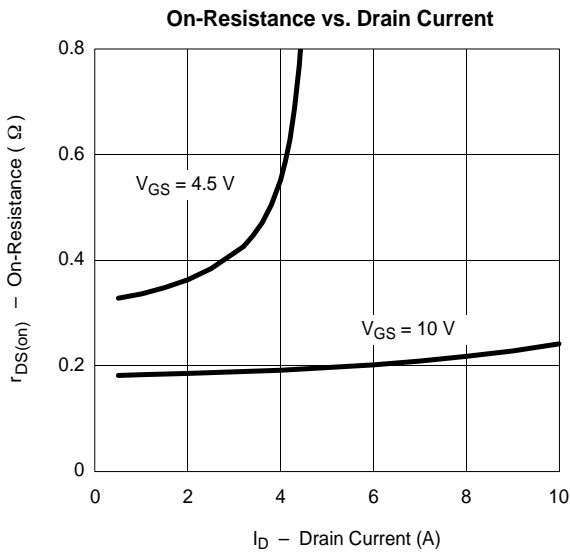
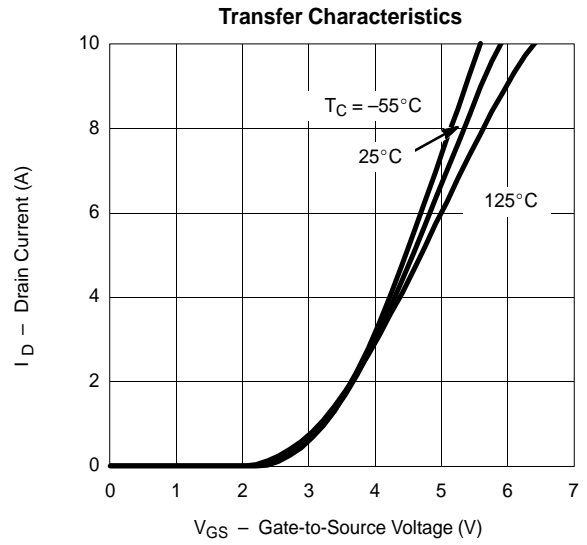
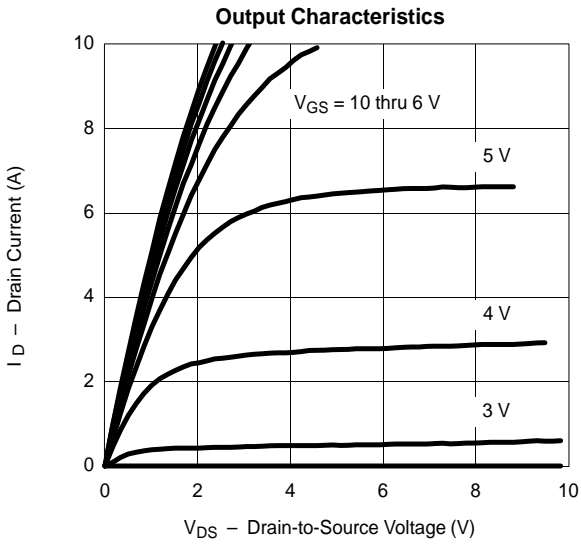

**LOW VOLTAGE MOSFET (P-CHANNEL)**

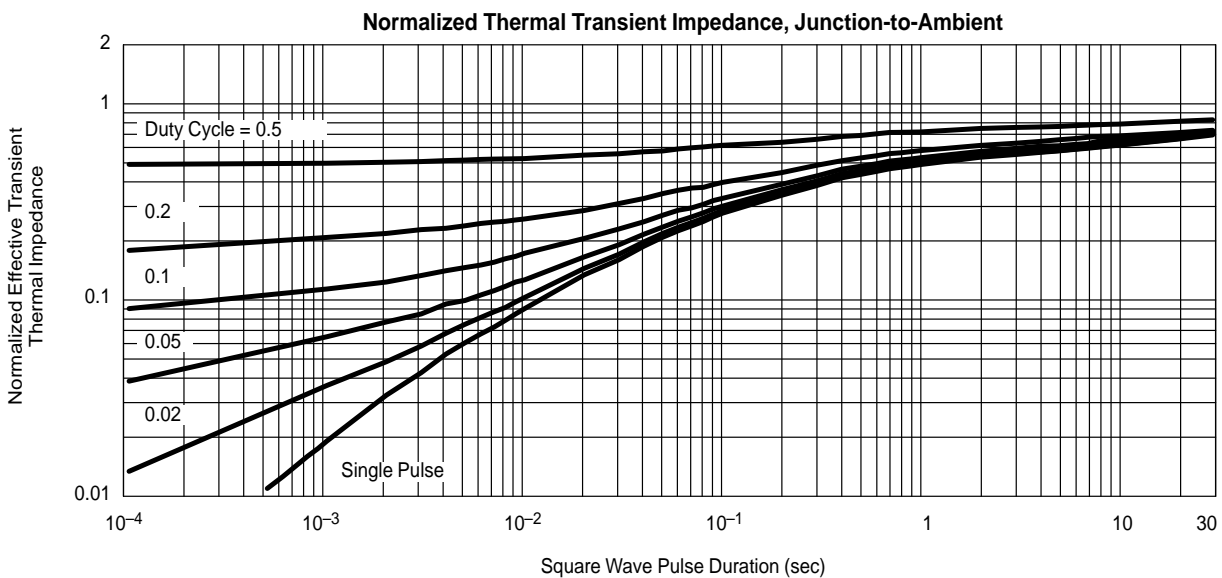
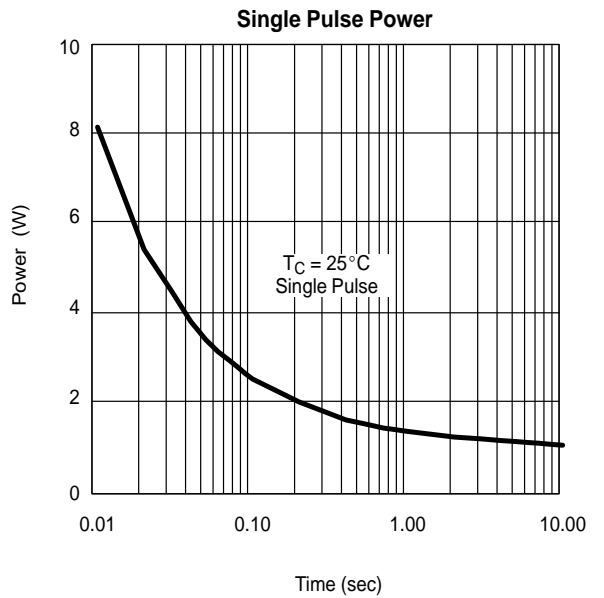
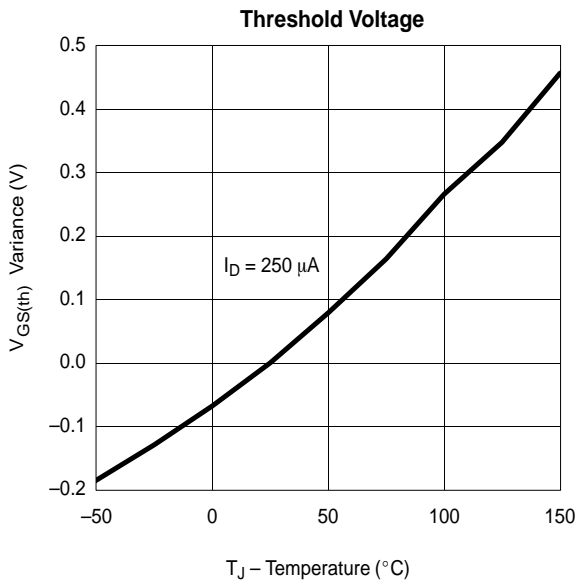
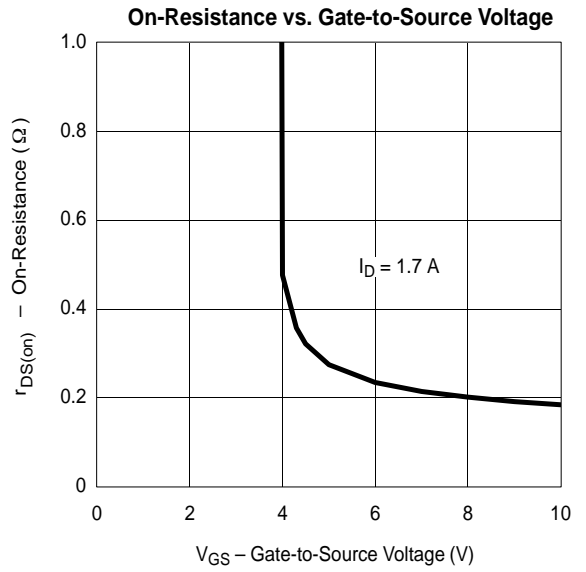
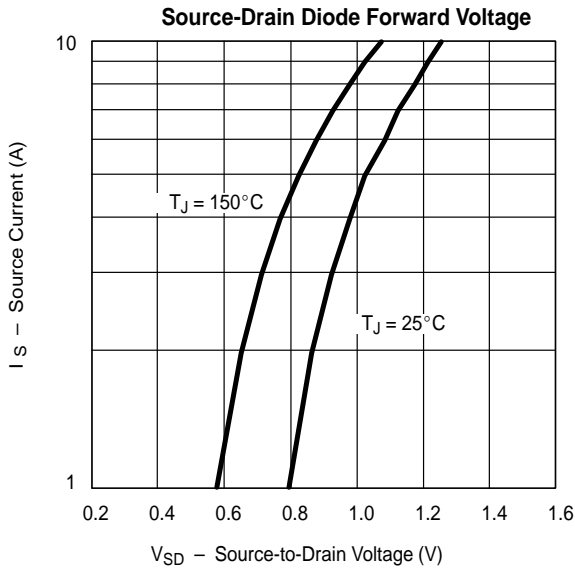

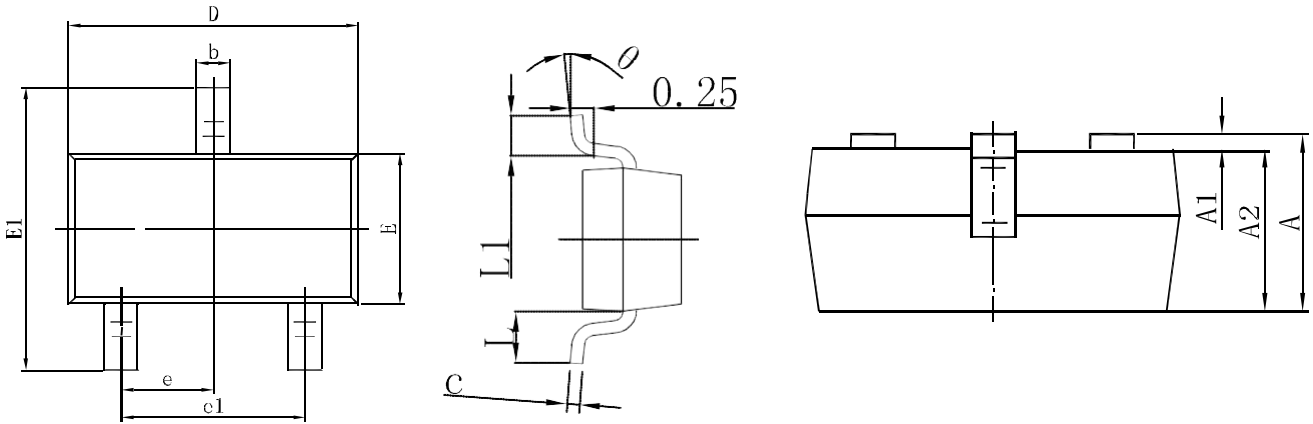
**LOW VOLTAGE MOSFET (P-CHANNEL)**
**SOT-23 Package Outline Dimensions**

Symbol	Dimensions In Millimeters		Dimensions In Inches	
	Min.	Max.	Min.	Max.
A	0.900	1.150	0.035	0.045
A1	0.000	0.100	0.000	0.004
A2	0.900	1.050	0.035	0.041
b	0.300	0.500	0.012	0.020
c	0.080	0.150	0.003	0.006
D	2.800	3.000	0.110	0.118
E	1.200	1.400	0.047	0.055
E1	2.250	2.550	0.089	0.100
e	0.950 TYP		0.037 TYP	
e1	1.800	2.000	0.071	0.079
L	0.550 REF		0.022 REF	
L1	0.300	0.500	0.012	0.020
$\theta$	0°	8°	0°	8°

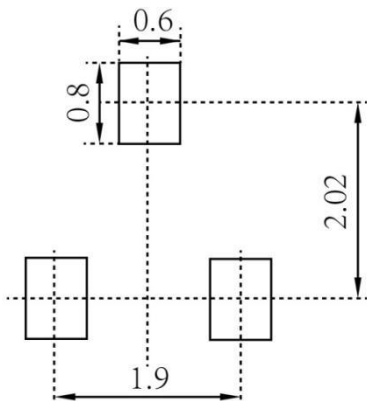
**SOT-23 Suggested Pad Layout**

**Note:**

1. Controlling dimension: in millimeters
2. General tolerance:  $\pm 0.05\text{mm}$
3. The pad layout is for reference purposes only

LOW VOLTAGE MOSFET (P-CHANNEL)

SOT-23 Tape and Reel

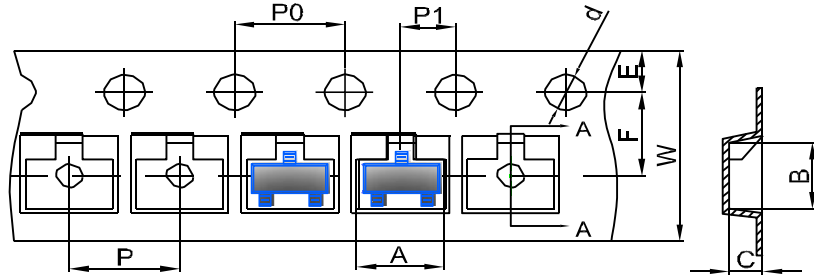
SOT-23 Embossed Carrier Tape



DIMENSIONS ARE IN MILLIMETER										
TYPE	A	B	C	d	E	F	P0	P	P1	W
SOT-23	3.15	2.77	1.22	Ø1.50	1.75	3.50	4.00	4.00	2.00	8.00
TOLERANCE	±0.1	±0.1	±0.1	±0.1	±0.1	±0.1	±0.1	±0.1	±0.1	±0.1

SOT-23 Tape Leader and Trailer

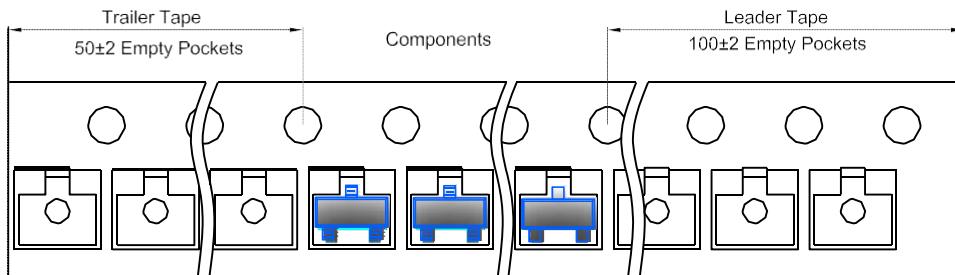

SOT-23 Reel

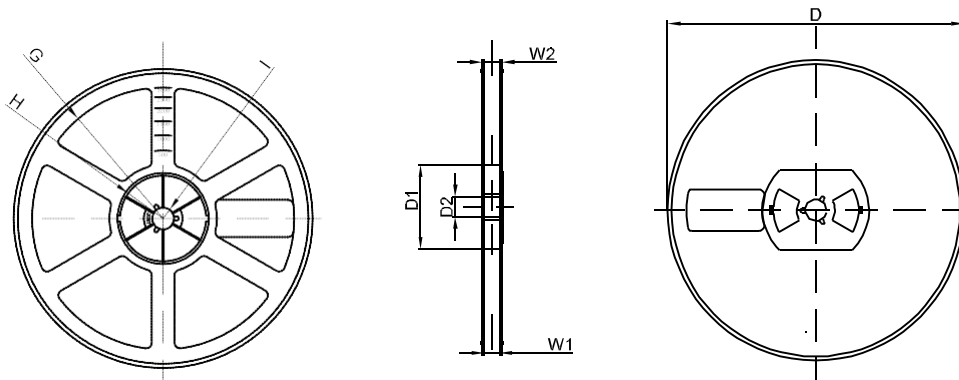

DIMENSIONS ARE IN MILLIMETER								
REEL OPTION	D	D1	D2	G	H	I	W1	W2
7" DIA	Ø178	54.40	13.00	R78	R25.60	R6.50	9.50	12.30
TOLERANCE	±2	±1	±1	±1	±1	±1	±1	±1