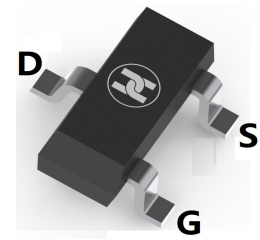
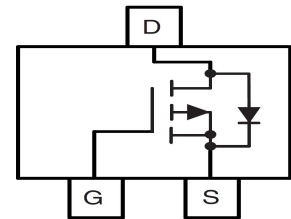

LOW VOLTAGE MOSFET (P-CHANNEL)
FEATURES

- $V_{DS}=-30V, R_{DS(ON)} \leq 88m\Omega @ V_{GS}=-10V, I_D=-2.7A$
- Low on-resistance
- For DC to DC converter and Load switch applications
- Surface Mount device

SOT-23

MECHANICAL DATA

- Case: SOT-23
- Case Material: Molded Plastic. UL flammability
- Classification Rating: 94V-0
- Moisture Sensitivity: Level 1 per J-STD-020
- Weight: 0.008 grams (approximate)

MAXIMUM RATINGS ($T_A = 25^\circ\text{C}$ unless otherwise noted)

Parameter	Symbol	Value	Unit
Drain-source voltage	V_{DS}	-30	V
Gate-source voltage	V_{GS}	± 20	V
Continuous drain current	I_D	-2.7	A
Continuous Source-Drain Diode current	I_S	-0.91	A
Power dissipation	P_D	1.1	W
Thermal resistance from Junction to ambient	$R_{\theta JA}$	114	$^\circ\text{C/W}$
Junction temperature	T_J	150	$^\circ\text{C}$
Storage temperature	T_{STG}	-55 ~ +150	$^\circ\text{C}$

ELECTRICAL CHARACTERISTICS ($T_A = 25^\circ\text{C}$ unless otherwise specified)

Parameter	Symbol	Min	Typ	Max	Unit	Conditions
Drain-Source breakdown voltage	$V_{(BR)DSS}$	-30			V	$V_{GS}=0V, I_D=-250\mu A$
Zero gate voltage drain current	I_{DSS}			-1	μA	$V_{DS}=-30V, V_{GS}=0V$
				-10	μA	$V_{DS}=-30V, V_{GS}=0V, T_J=55^\circ\text{C}$
Gate-body leakage current	I_{GSS}			± 100	nA	$V_{DS}=0V, V_{GS}=\pm 20V$
Gate-threshold voltage (note 1)	$V_{GS(th)}$	-1		-3	V	$V_{DS}=V_{GS}, I_D=-250\mu A$
Drain-source on-resistance (note 1)	$R_{DS(ON)}$		110	138	m Ω	$V_{GS}=-4.5V, I_D=-2.8A$
			73	88	m Ω	$V_{GS}=-10V, I_D=-3.5A$
Forward transconductance (note 1)	g_{FS}		7		S	$V_{DS}=-10V, I_D=-3.5A$
Gate resistance	R_g		10		Ω	$f=1\text{MHz}$
Input capacitance	C_{iss}		340		pF	$V_{DS}=-15V, V_{GS}=0V, f=1\text{MHz}$
Output capacitance	C_{oss}		67		pF	
Reverse transfer capacitance	C_{rss}		51		pF	
Turn-on delay time	$t_{d(on)}$		40	60	nS	$V_{DD}=-15V, I_D=-1A, V_{GEN}=-4.5V, R_g=1\Omega, R_L=15\Omega$
Turn-on rise time	t_r		40	60	nS	
Turn-off delay time	$t_{d(off)}$		20	40	nS	
Turn-off fall time	t_f		17	30	nS	
Total gate charge	Q_g		4.1	6.2	nC	$V_{DS}=-15V, V_{GS}=-4.5V, I_D=-2.5A$
Gate-source charge	Q_{gs}		0.7		nC	
Gate-drain charge	Q_{gd}		1.3		nC	
Diode forward voltage (note 1)	V_{SD}		-0.8	-1.2	V	$I_S=-0.75A, V_{GS}=0V$

Note: 1. Pulse test ; Pulse width $\leq 300\mu s$, Duty cycle $\leq 2\%$.

LOW VOLTAGE MOSFET (P-CHANNEL)

Typical Characteristics

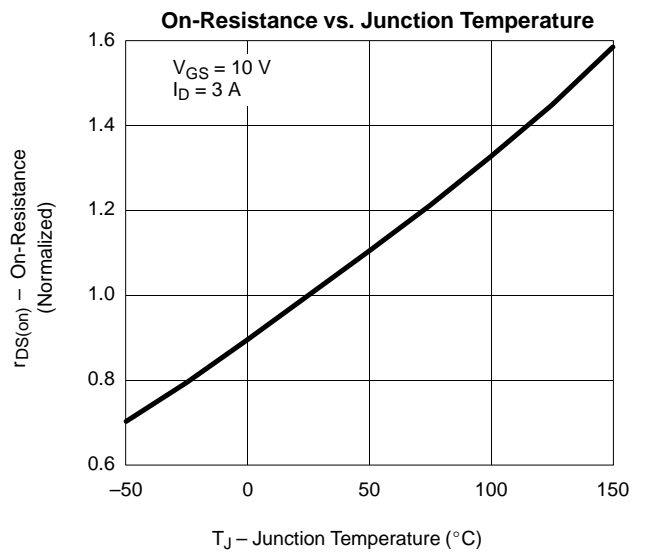
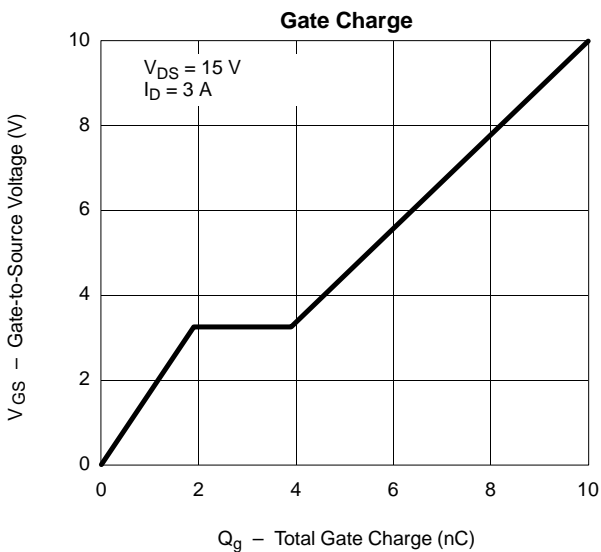
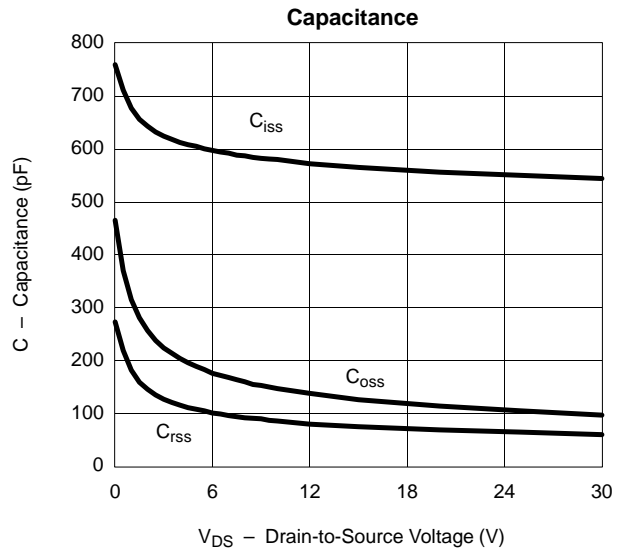
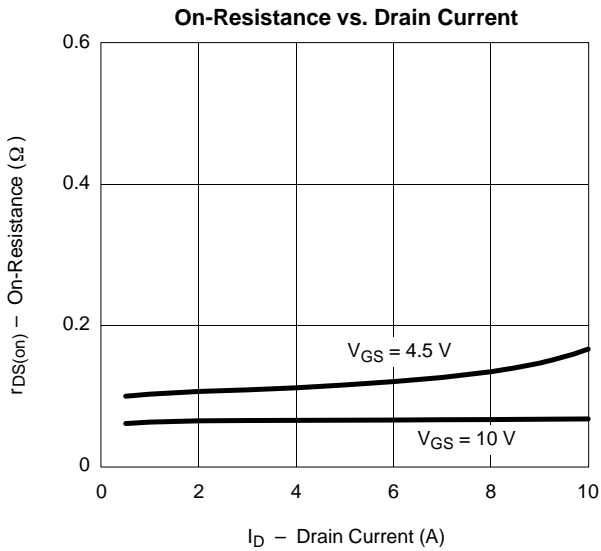
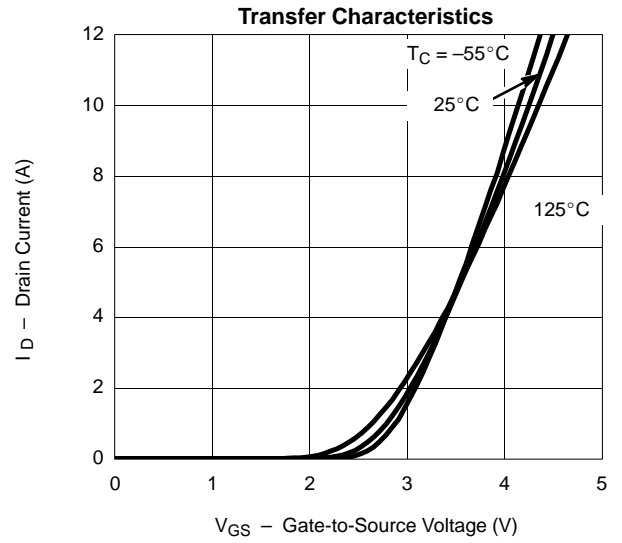
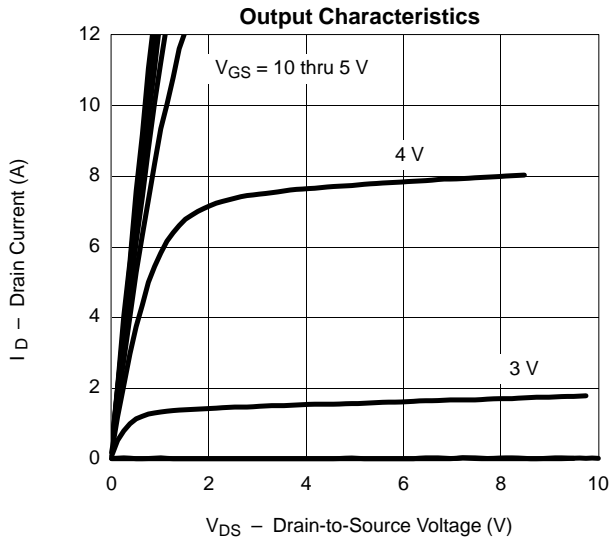

LOW VOLTAGE MOSFET (P-CHANNEL)

Source-Drain Diode Forward Voltage

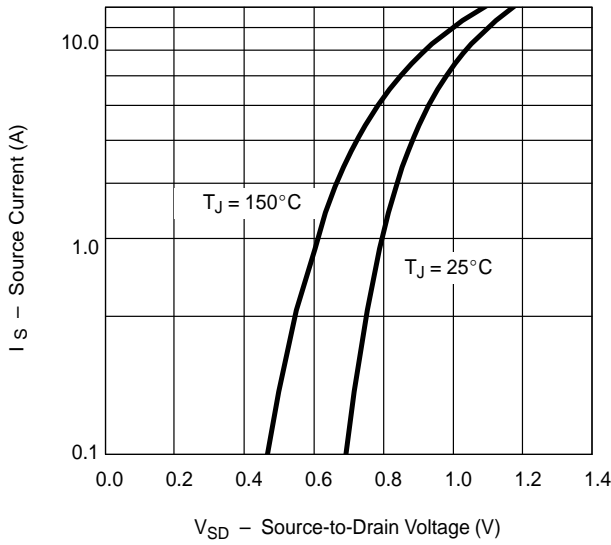

On-Resistance vs. Gate-to-Source Voltage

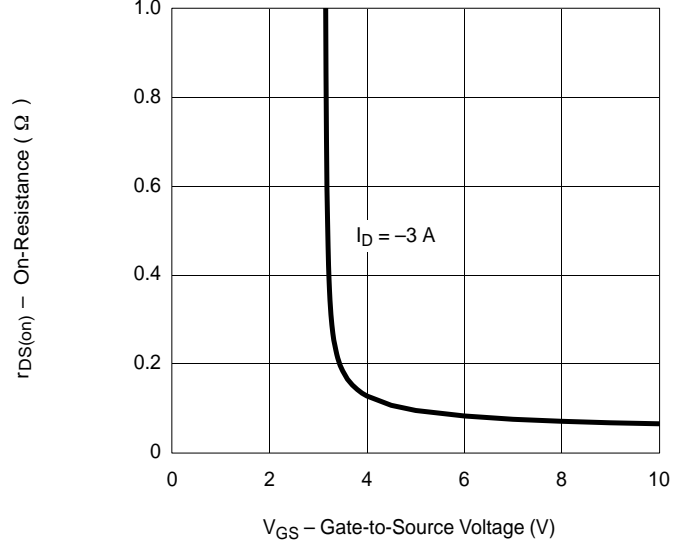

Threshold Voltage

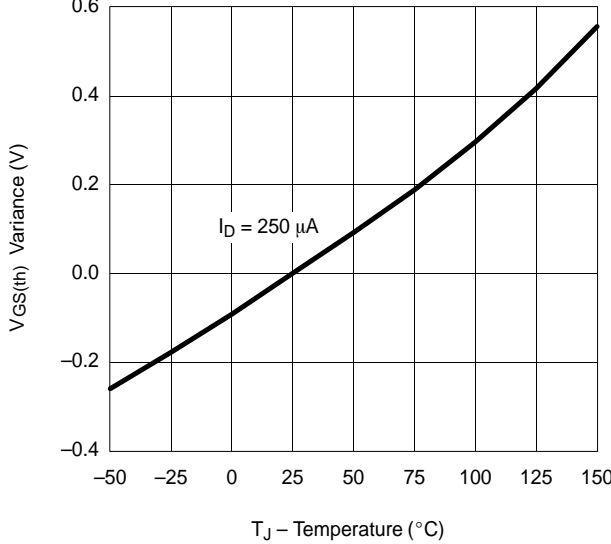

Single Pulse Power

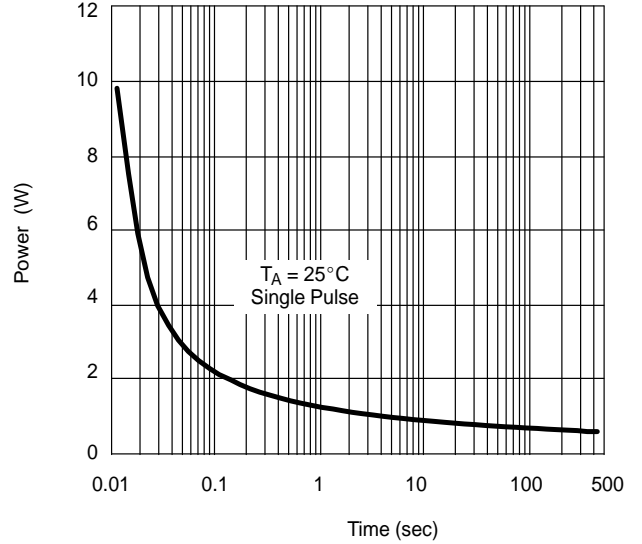

Normalized Thermal Transient Impedance, Junction-to-Ambient

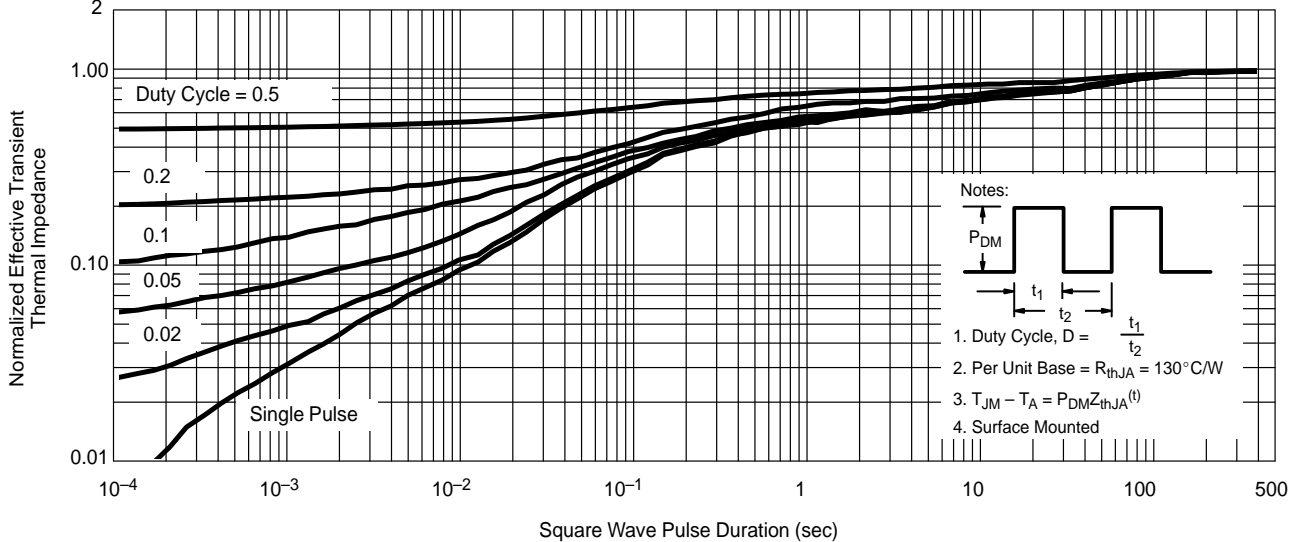

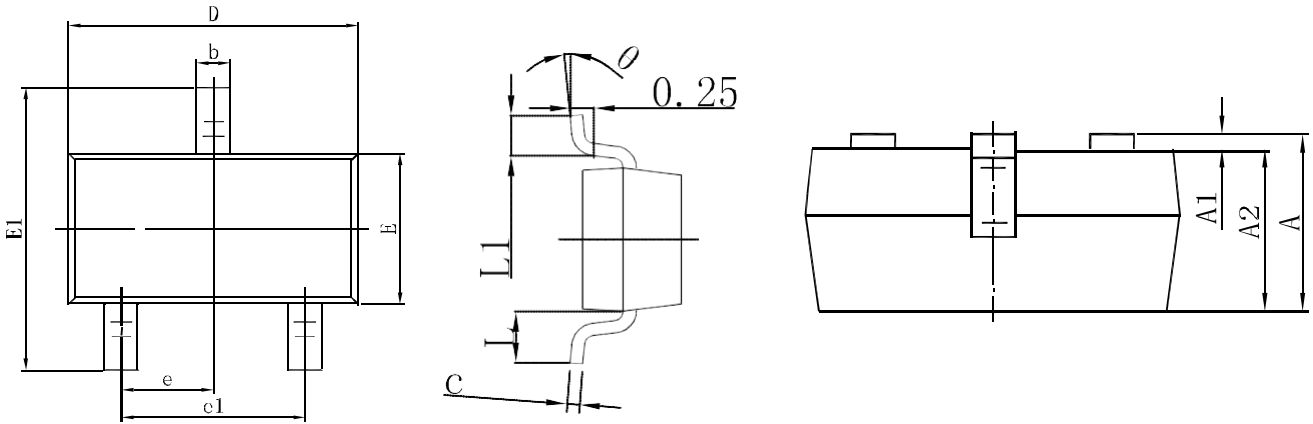
LOW VOLTAGE MOSFET (P-CHANNEL)
SOT-23 Package Outline Dimensions

Symbol	Dimensions In Millimeters		Dimensions In Inches	
	Min.	Max.	Min.	Max.
A	0.900	1.150	0.035	0.045
A1	0.000	0.100	0.000	0.004
A2	0.900	1.050	0.035	0.041
b	0.300	0.500	0.012	0.020
c	0.080	0.150	0.003	0.006
D	2.800	3.000	0.110	0.118
E	1.200	1.400	0.047	0.055
E1	2.250	2.550	0.089	0.100
e	0.950 TYP		0.037 TYP	
e1	1.800	2.000	0.071	0.079
L	0.550 REF		0.022 REF	
L1	0.300	0.500	0.012	0.020
θ	0°	8°	0°	8°

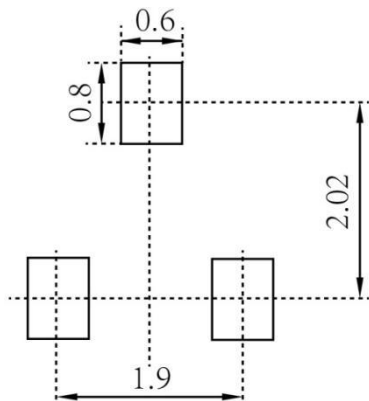
SOT-23 Suggested Pad Layout

Note:

1. Controlling dimension: in millimeters
2. General tolerance: $\pm 0.05\text{mm}$
3. The pad layout is for reference purposes only

LOW VOLTAGE MOSFET (P-CHANNEL)

SOT-23 Tape and Reel

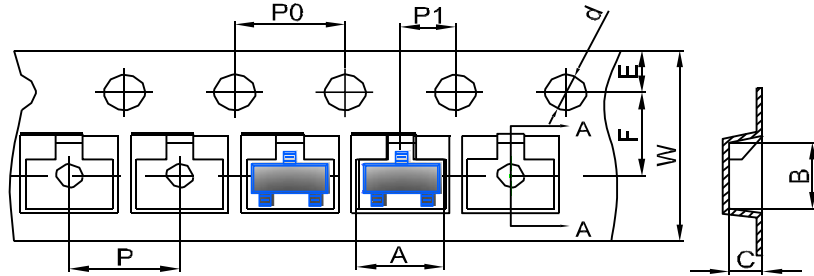
SOT-23 Embossed Carrier Tape



DIMENSIONS ARE IN MILLIMETER										
TYPE	A	B	C	d	E	F	P0	P	P1	W
SOT-23	3.15	2.77	1.22	Ø1.50	1.75	3.50	4.00	4.00	2.00	8.00
TOLERANCE	±0.1	±0.1	±0.1	±0.1	±0.1	±0.1	±0.1	±0.1	±0.1	±0.1

SOT-23 Tape Leader and Trailer

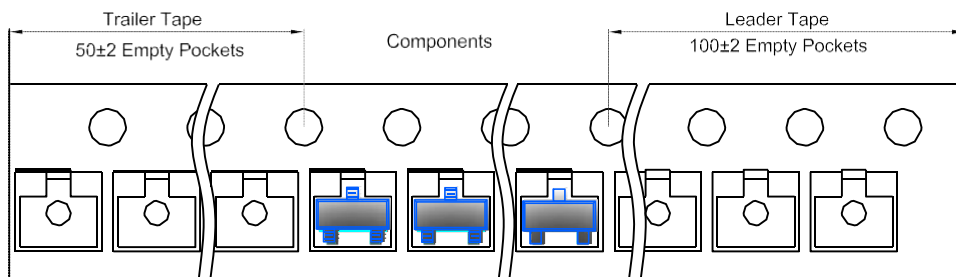

SOT-23 Reel

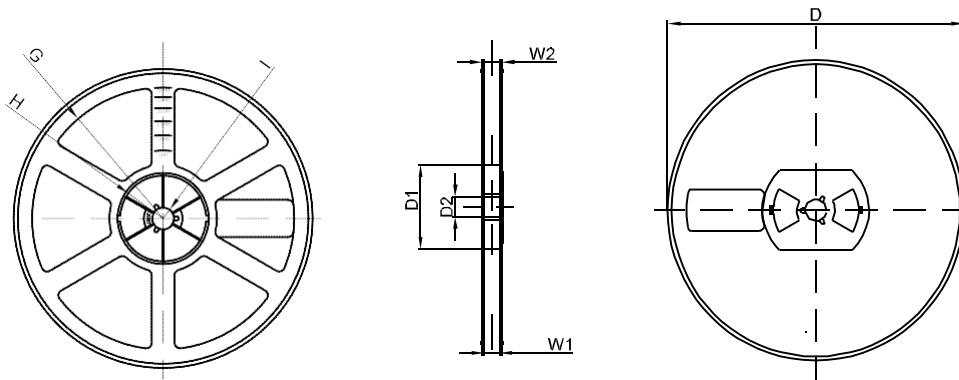

DIMENSIONS ARE IN MILLIMETER								
REEL OPTION	D	D1	D2	G	H	I	W1	W2
7" DIA	Ø178	54.40	13.00	R78	R25.60	R6.50	9.50	12.30
TOLERANCE	±2	±1	±1	±1	±1	±1	±1	±1