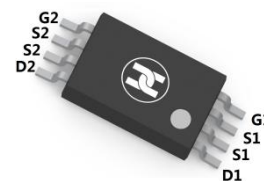
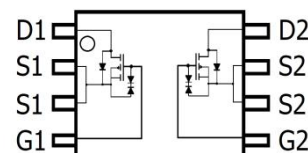

**DUAL P-CHANNEL ENHANCEMENT MODE FET**
**FEATURES**

- Ultra low on-resistance:  $V_{DS}=-20V, I_D=-4.7A, R_{DS(ON)} \leq 42m\Omega @ V_{GS}=-4.5V$
- Low gate charge
- ESD protected
- Surface Mount device

**TSSOP-8**

**MECHANICAL DATA**

- Case: TSSOP-8
- Case Material: Molded Plastic. UL flammability
- Classification Rating: 94V-0
- Moisture Sensitivity: Level 1 per J-STD-020
- Weight: not available

**MAXIMUM RATINGS ( $T_A = 25^\circ\text{C}$  unless otherwise noted)**

Parameter	Symbol	Value	Unit	
Drain-source voltage	$V_{DS}$	-20	V	
Gate-source voltage	$V_{GS}$	$\pm 8$	V	
Continuous drain current	$I_D$	$T_A = 25^\circ\text{C}$	-4.7	A
		$T_A = 70^\circ\text{C}$	-3.7	A
Pulsed drain current	$I_{DM}$	-30	A	
Power dissipation	$P_D$	$T_A = 25^\circ\text{C}$	1.4	W
		$T_A = 70^\circ\text{C}$	0.9	W
Thermal resistance from Junction to ambient	$R_{\theta JA}$	125	$^\circ\text{C/W}$	
Thermal resistance from Junction to Lead	$R_{\theta JL}$	75	$^\circ\text{C/W}$	
Junction temperature	$T_J$	150	$^\circ\text{C}$	
Storage temperature	$T_{STG}$	-55 ~ +150	$^\circ\text{C}$	

**ELECTRICAL CHARACTERISTICS ( $T_A = 25^\circ\text{C}$  unless otherwise specified)**

Parameter	Symbol	Min	Typ	Max	Unit	Conditions
Drain-Source breakdown voltage	$V_{(BR)DSS}^*$	-20			V	$V_{GS}=0V, I_D=250\mu A$
Zero gate voltage drain current	$I_{DSS}^*$			-1	$\mu A$	$V_{DS}=-16V, V_{GS}=0V$
Gate-body leakage current	$I_{GSS}^*$			$\pm 1$	$\mu A$	$V_{DS}=0V, V_{GS}=\pm 4.5V$
				$\pm 10$	$\mu A$	$V_{DS}=0V, V_{GS}=\pm 8V$
Gate-threshold voltage	$V_{GS(th)}^*$	-0.3	-0.55	-1	V	$V_{DS}=V_{GS}, I_D=-250\mu A$
On-State Drain Current	$I_{D(ON)}^*$	-25			A	$V_{DS}=-5V, V_{GS}=-4.5V$
Drain-source on-resistance	$R_{DS(ON)}^*$		35	42	$m\Omega$	$V_{GS}=-4.5V, I_D=-4.7A$
			47	57	$m\Omega$	$V_{GS}=-4.5V, I_D=-4.7A, T_J=125^\circ\text{C}$
			44	53	$m\Omega$	$V_{GS}=-2.5V, I_D=-4A$
			54	70	$m\Omega$	$V_{GS}=-1.8V, I_D=-2A$
Forward transconductance	$g_{FS}$	8	16		S	$V_{DS}=-5V, I_D=-4.7A$
Diode forward voltage	$V_{SD}$		-0.78	-1	V	$I_S=-1A, V_{GS}=0V$
Diode forward current	$I_S$			-2.2	A	
Input capacitance	$C_{iss}$		1450		pF	$V_{DS}=-10V, V_{GS}=0V, f=1\text{MHz}$
Output capacitance	$C_{oss}$		205		pF	
Reverse transfer capacitance	$C_{rss}$		160		pF	
Gate resistance	$R_g$		6.5		$\Omega$	$V_{DS}=0V, V_{GS}=0V, f=1\text{MHz}$
Total gate charge	$Q_g$		17.2		nC	$V_{GS}=-4.5V, V_{DS}=-10V, I_D=-4A$
Gate-source charge	$Q_{gs}$		1.3		nC	
Gate-drain charge	$Q_{gd}$		4.5		nC	
Turn-on delay time	$t_{d(on)}$		9.5		nS	$V_{GS}=-4.5V, V_{DS}=-10V, R_{GEN}=3\Omega, R_L=2.5\Omega$
Turn-on rise time	$t_r$		17		nS	
Turn-off delay time	$t_{d(off)}$		94		nS	
Turn-off fall time	$t_f$		35		nS	
Body Diode Reverse Recovery Time	$t_{rr}$		31		nS	$I_F=-4A, dI/dt=100A/\mu S$
Body Diode Reverse Recovery Charge	$Q_{rr}$		13.8		nC	$I_F=-4A, dI/dt=100A/\mu S$

\*Pulse test ; Pulse width  $\leq 80\mu s$ , Duty cycle  $\leq 0.5\%$  .

**DUAL P-CHANNEL ENHANCEMENT MODE FET**

TYPICAL ELECTRICAL AND THERMAL CHARACTERISTICS

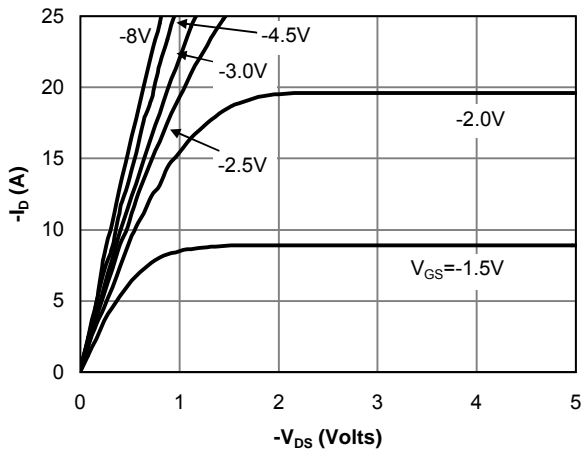

Fig 1: On-Region Characteristics

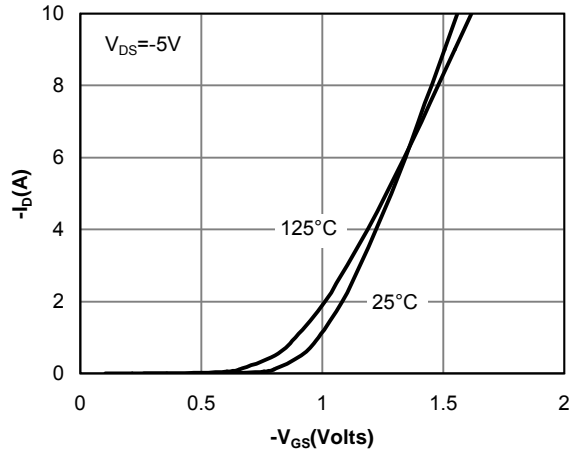

Figure 2: Transfer Characteristics

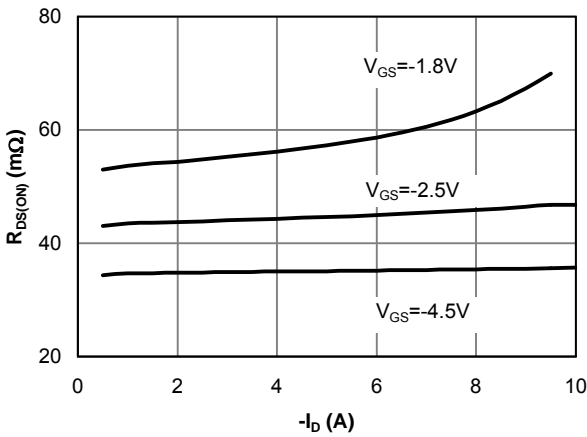

Figure 3: On-Resistance vs. Drain Current and Gate Voltage

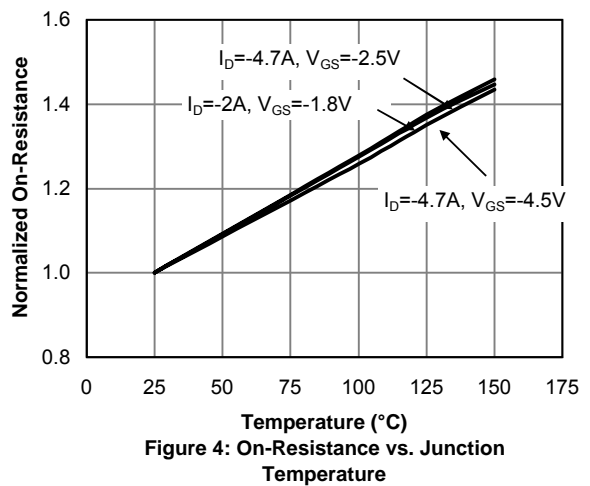

Figure 4: On-Resistance vs. Junction Temperature

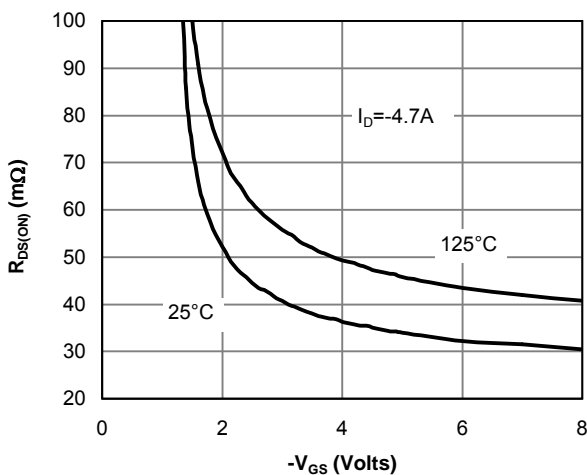

Figure 5: On-Resistance vs. Gate-Source Voltage

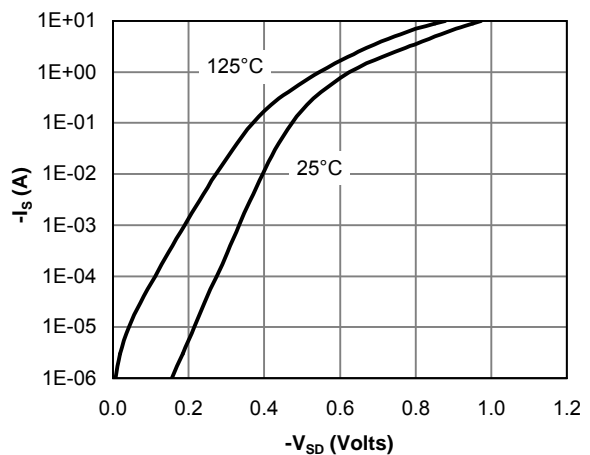
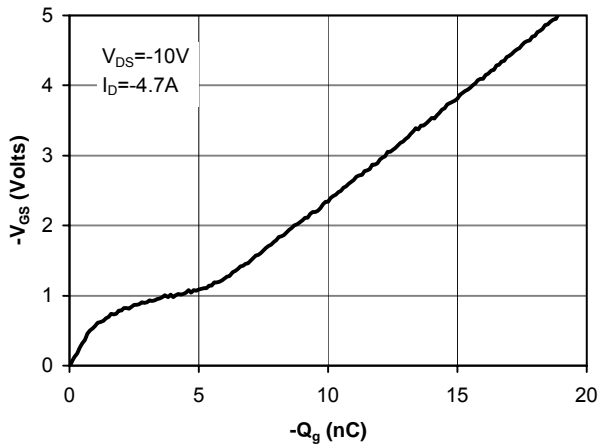

Figure 6: Body-Diode Characteristics

**DUAL P-CHANNEL ENHANCEMENT MODE FET**

**TYPICAL ELECTRICAL AND THERMAL CHARACTERISTICS**



**Figure 7: Gate-Charge Characteristics**

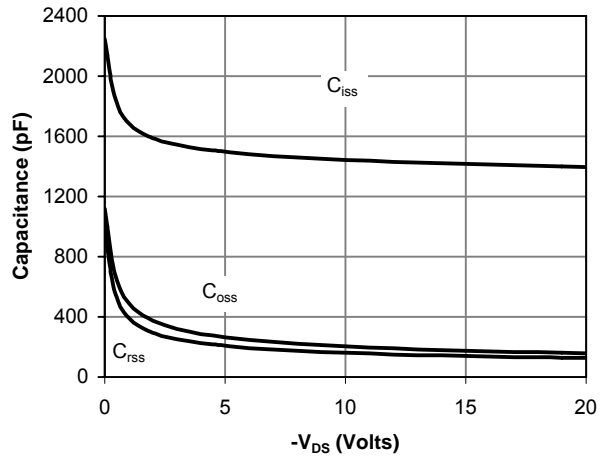

**Figure 8: Capacitance Characteristics**

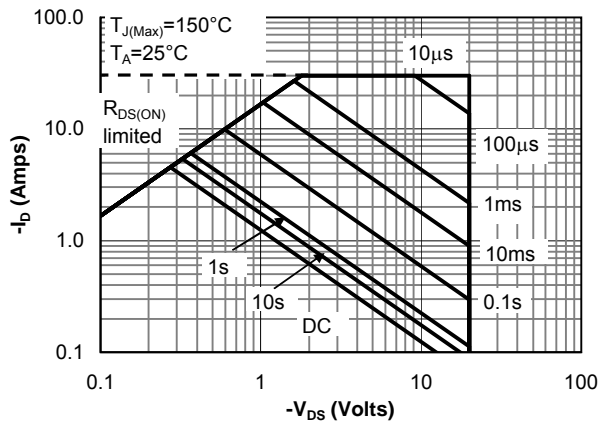

**Figure 9: Maximum Forward Biased Safe Operating Area**

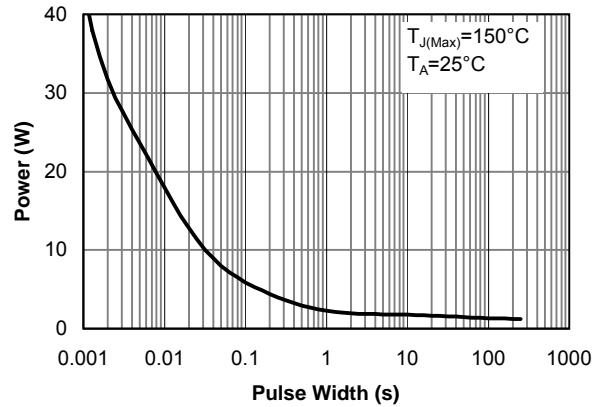

**Figure 10: Single Pulse Power Rating Junction-to-Ambient**

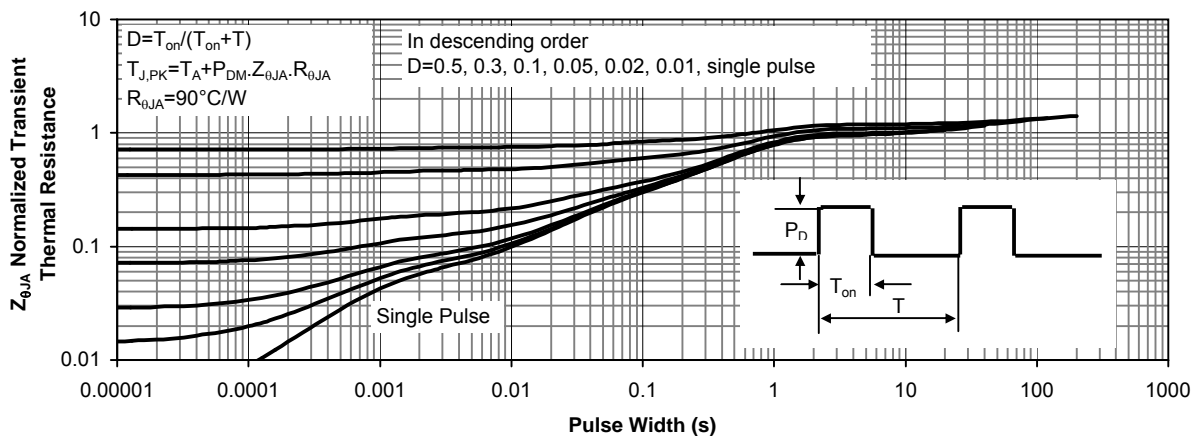

**Figure 11: Normalized Maximum Transient Thermal Impedance**

**DUAL P-CHANNEL ENHANCEMENT MODE FET**

**SOP-8 Package Outline Dimensions**

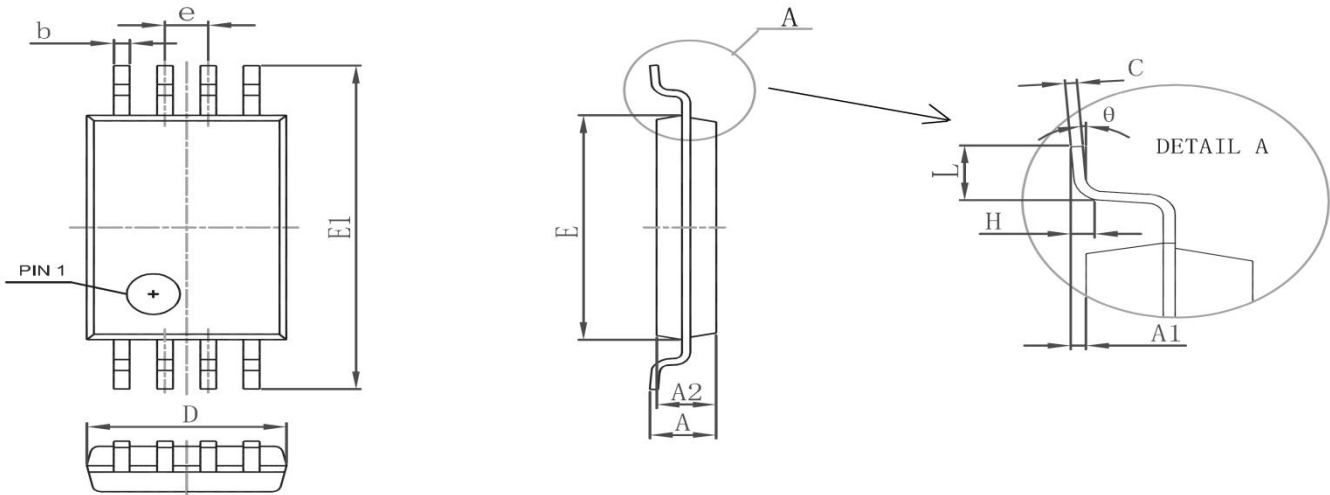

Symbol	Dimensions In Millimeters		Dimensions In Inches	
	Min.	Max.	Min.	Max.
D	2.900	3.100	0.114	0.122
E	4.300	4.500	0.169	0.177
b	0.190	0.300	0.007	0.012
c	0.090	0.200	0.004	0.008
E1	6.250	6.550	0.246	0.258
A		1.200		0.047
A2	0.800	1.000	0.031	0.039
A1	0.050	0.150	0.002	0.006
e	0.65(BSC)		0.026(BSC)	
L	0.500	0.700	0.020	0.028
H	0.25(TYP)		0.01(TYP)	
θ	1°	7°	1°	7°

**SOP-8 Suggested Pad Layout**

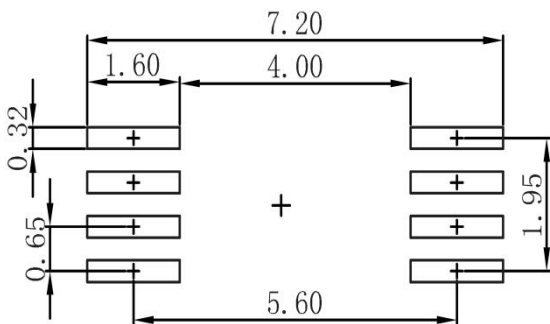

**Note:**

1. Controlling dimension: in millimeters
2. General tolerance: ±0.05mm
3. The pad layout is for reference purposes only

## DUAL P-CHANNEL ENHANCEMENT MODE FET

### SOP-8 Tape and Reel

#### SOP-8 Embossed Carrier Tape

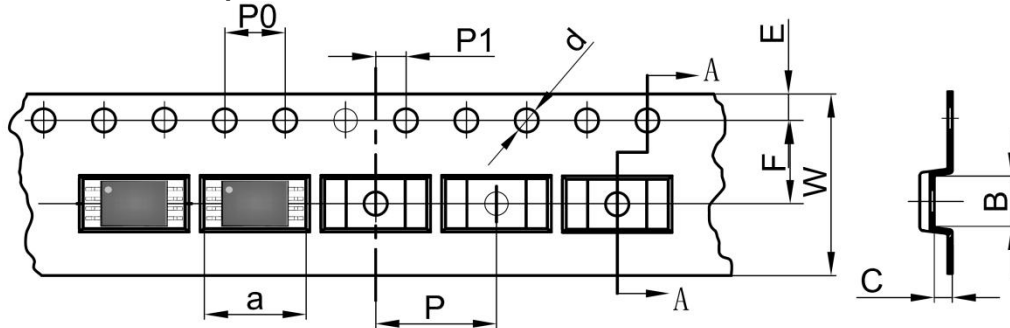

DIMENSIONS ARE IN MILLIMETER										
TYPE	a	B	C	d	E	F	P0	P	P1	W
SOP-8	6.76	3.30	1.20	Ø1.50	1.75	5.50	4.00	8.00	2.00	12.00
TOLERANCE	±0.1	±0.1	±0.1	±0.1	±0.1	±0.1	±0.1	±0.1	±0.1	±0.1

#### SOP-8 Tape Leader and Trailer

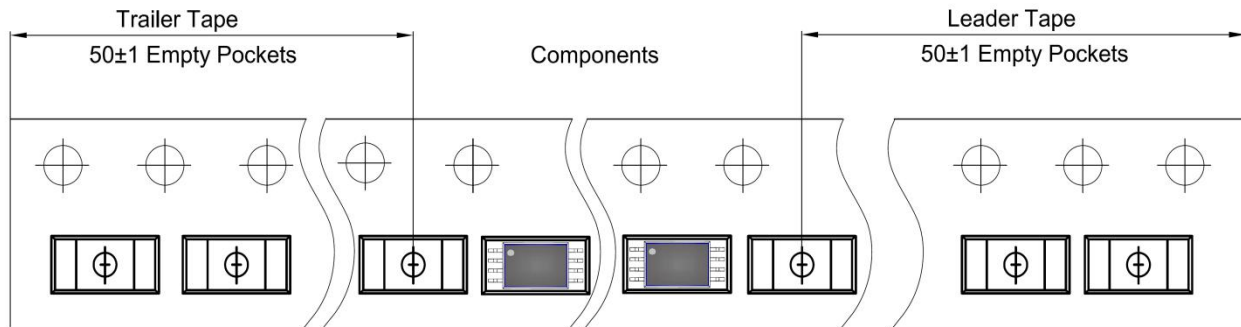

#### SOP-8 Reel

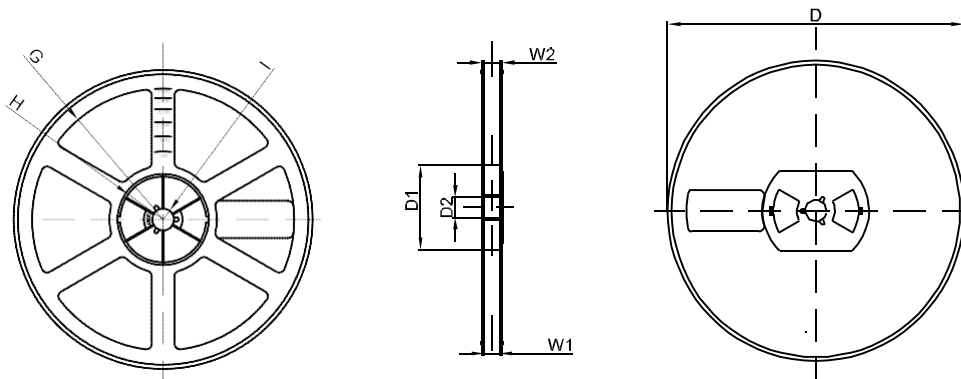

DIMENSIONS ARE IN MILLIMETER								
REEL OPTION	D	D1	D2	G	H	I	W1	W2
13" DIA	Ø330.00	100.00	13.00	R151.00	R56.00	R6.50	12.40	17.60
TOLERANCE	±2	±1	±1	±1	±1	±1	±1	±1