

TCXO, VCTCXO

Temperature Compensated Crystal Oscillator

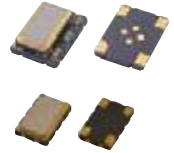

Application

- For GSM & CDMA Mobile

Features

- Stable Frequency Stability over Temperature
- Low Phase Noise & Low Power Supply
- Miniature Size

Specification

Model	TCXO, VCTCXO
Frequency Range, MHz	10.0 ~ 26.0
Dimensions, mm	7.2x5.2x1.9
	5.1x3.3x1.4
	3.2x2.5x1.3
Frequency Stability, ppm	±1.0 ~ ±3.0
Supply Voltage, V	+2.7 ~ +5.5
Supply current, mA	2.0 max
Operating Temp, °C	-30 ~ +75
Storage Temp, °C	-40 ~ +85
Start Up Time, ms	3 max
Frequency Adjustment	None ±8ppm min, +1.5V ±1.0V
Aging, PPM	±1.0 max first year
Stability 24hrs after reflow, ppm	±1.0 max

Standart Frequencies

Standart Frequencies in MHz	
12.80000	19.20000
13.00000	19.44000
14.40000	19.68000
15.36000	19.80000
16.00000	26.00000

Other frequencies available. Please consult our sales office.

Surface Mount Dimension, mm

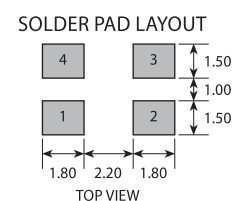
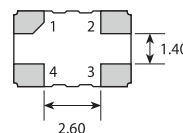
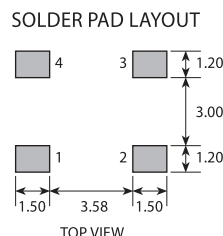
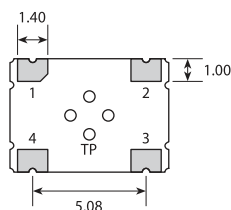
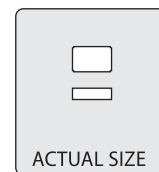
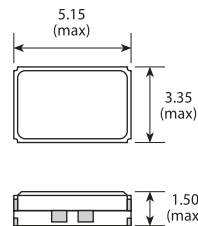
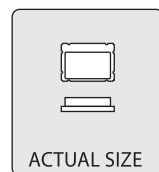
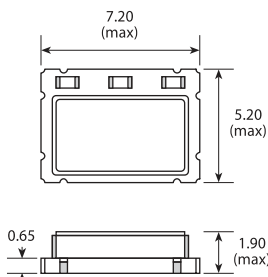

PAD	CONNECTION
1	Ground or Freq adjustment
2	Ground
3	Output
4	Supply

TP - Test Points

PAD	CONNECTION
1	Ground or Freq adjustment
2	Ground
3	Output
4	Supply

TCXO, VCTCXO

Temperature Compensated Crystal Oscillator

Construction

- Ceramic body with gold-plated pads
- Metal lid, seam sealed

Packing & Handling

Production quantities supplied on T & R,
1k pcs per reel.
Small quantities may be supplied on tape
(no reel), or in bulk.

Soldering Profile

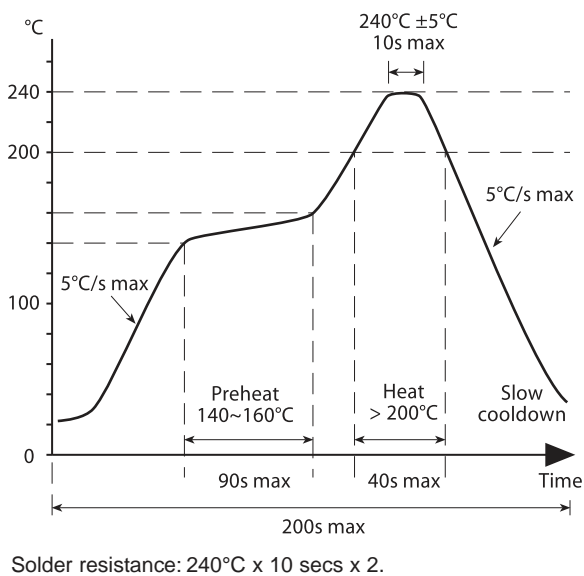

Tape & Reel Specification

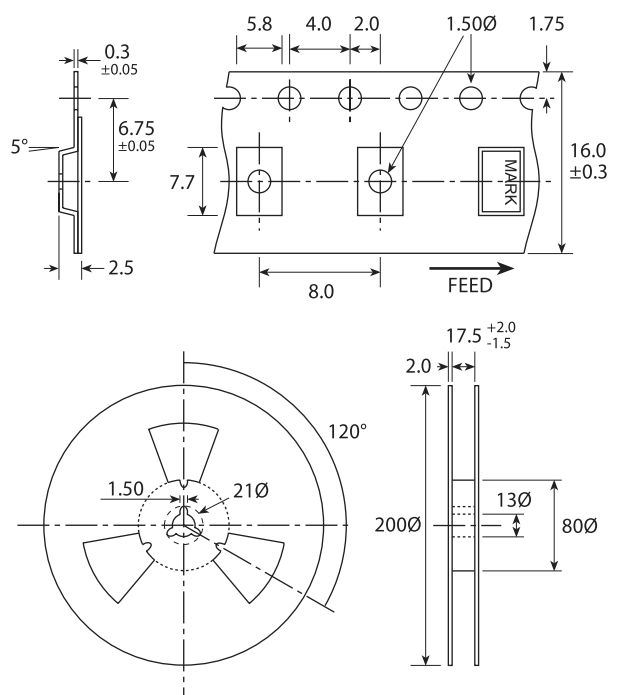

Not to scale. Dimensions in mm. Tolerances ±0.1mm unless otherwise stated