

建议PCB尺寸

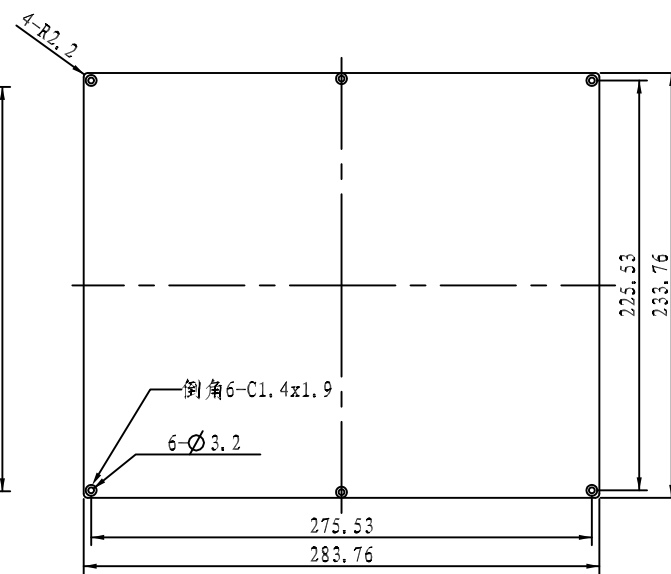

面板

安装说明 (Installation instructions)

型号Code: 11-191
尺寸Size: 319x294x130mm
防护等级ProtectionClass: IP65

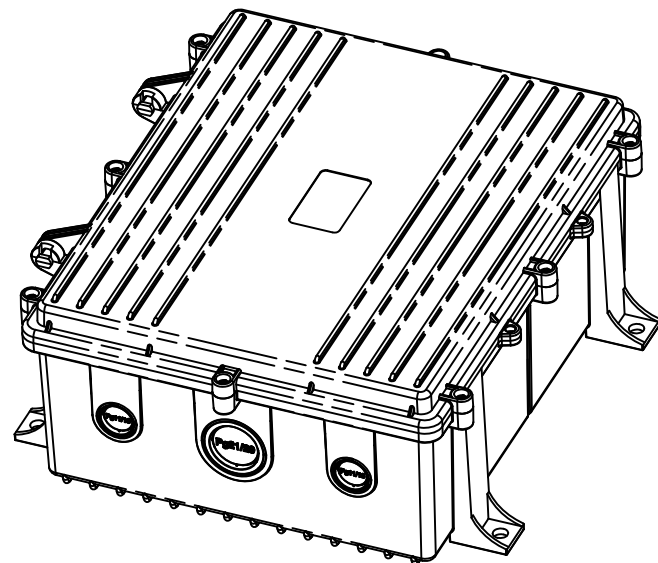
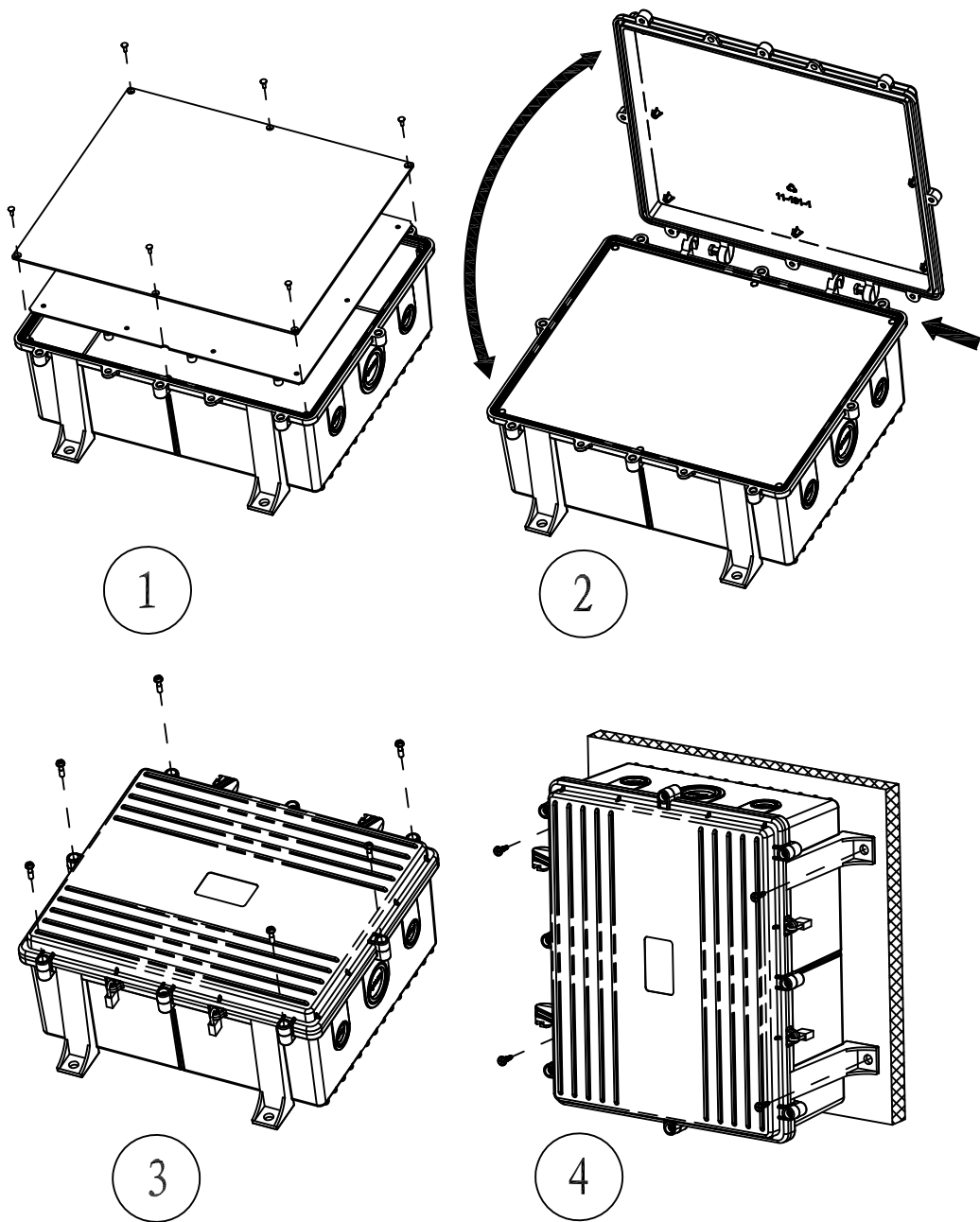

宁波三和壳体公司
NINGBO SANHE ENCLOSURE CORPORATION

<http://www.china-mould.com>