

剖面 A-A

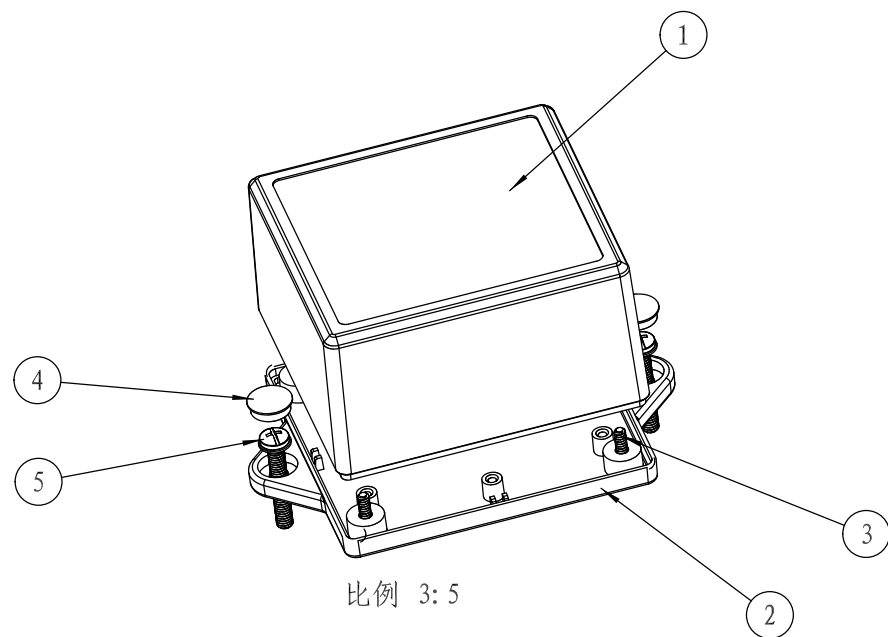

比例 3:5

5						
4	19-81-3	螺丝盖子	2	普通ABS		
3	PT3X8	PT3x8十字圆头自攻螺钉	4	铁		
2	19-85-2	下壳	1	普通ABS		
1	19-85-1	上壳	1	普通ABS		
<u>序号</u> Number	<u>产品编号</u> Product Code	<u>零件名称</u> Part Name	<u>数量</u> Quantity	<u>材料</u> Material	<u>重量(g)</u> Weight	<u>备注</u> Remarks
<u>制图</u> Drawing	<u>审核</u> Auditing	<u>批准</u> Confirm	<u>客户名称</u> Custom Name	<u>材料</u> Material		
			<u>产品名称</u> Product Name	装配图	<u>图纸比例</u> Drawing Scale	1:1 A3
			<u>产品编号</u> Product Code	19-85	<u>视图</u> Project View	(mm)
共 页 第 页			宁波三和壳体公司 NINGBO SANHE ENCLOSURE CORPORATION		中国·宁波慈溪 TEL:+86(574)63226910 FAX:+86(574)63226900	