

比例 1:1

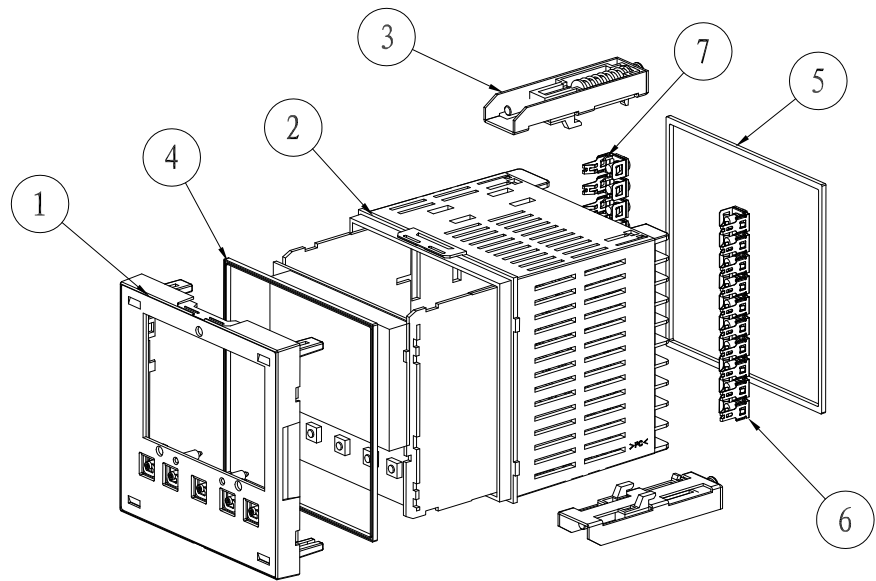

比例 1:2

10	96122-XLB3	线路板	1			
9	96122-XLB2	线路板	1			
8	96122-XLB1	线路板	1			
7	4990-7	铜插件	20	黄铜 (0.8MM)		
6	4990-6	弹片	20	皮青铜 (0.2MM)	M3.5*7 (20个) (二组合螺丝7*7)	
5	96122-4	大密封圈	1	橡胶		
4	96122-3	小密封圈	1	橡胶		
3	4990-3	安装架	2			
2	96122-2	壳体	1	PC		
1	96122-1	面框	1	PC		
序号	编号	名称	数量	材料	单重 (g)	备注
制图	审核	批准	客户名称	材料		1:1 A3 (mm)
Drawing	Auditing	Confirm	Custom Name	Material		
			产品名称	图纸比例		
			Product Name	Drawing Scale		
			产品编号	视图		
			Product Code	Project View		
共 1 页			第 1 页		宁波三和壳体公司 NINGBO SANHE ENCLOSURE CORPORATION 中国宁波慈溪 TEL: +86(574)63226910 FAX: +86(574)63226900	

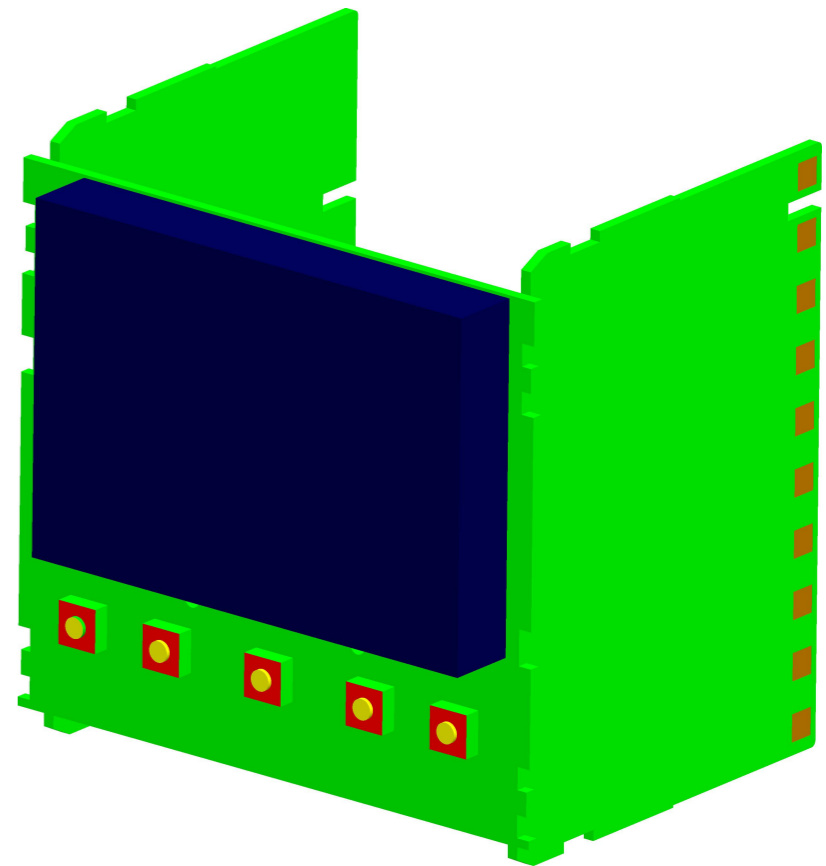
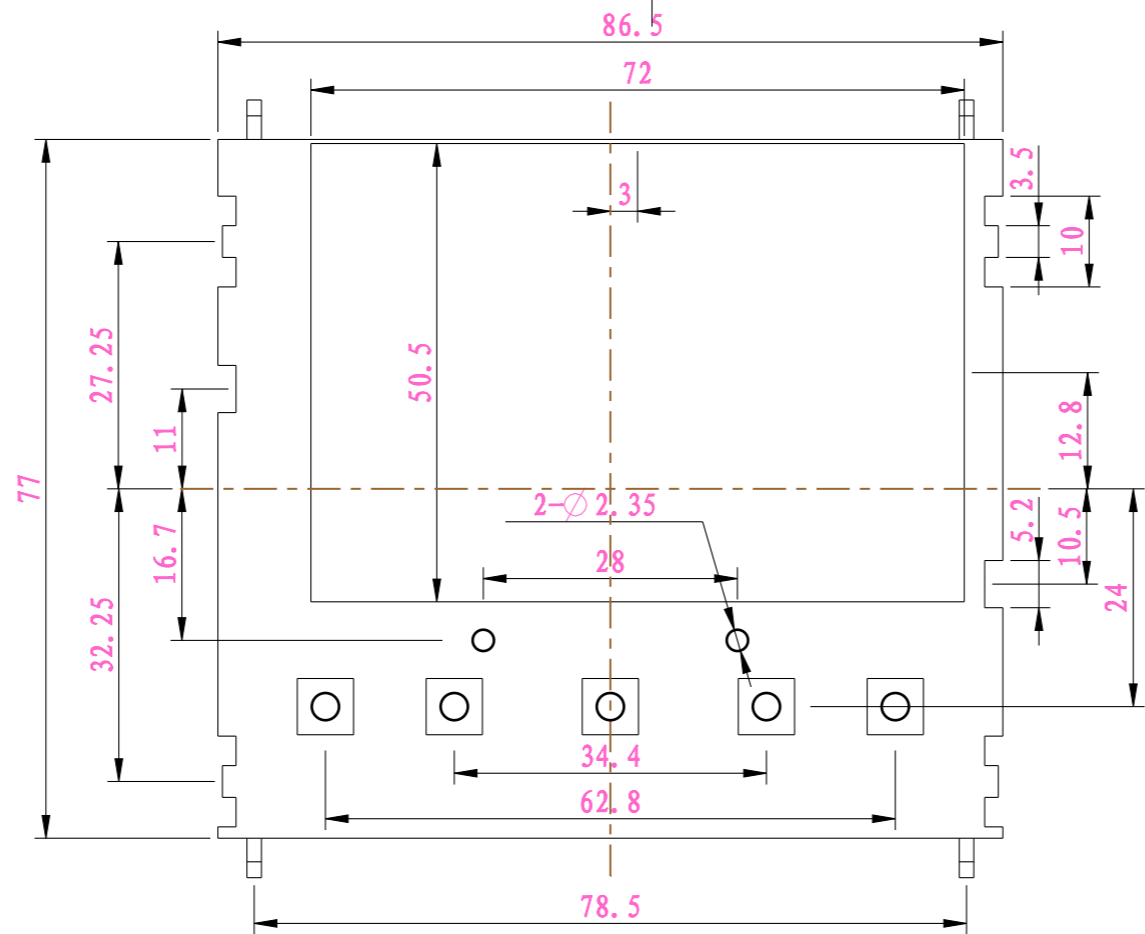

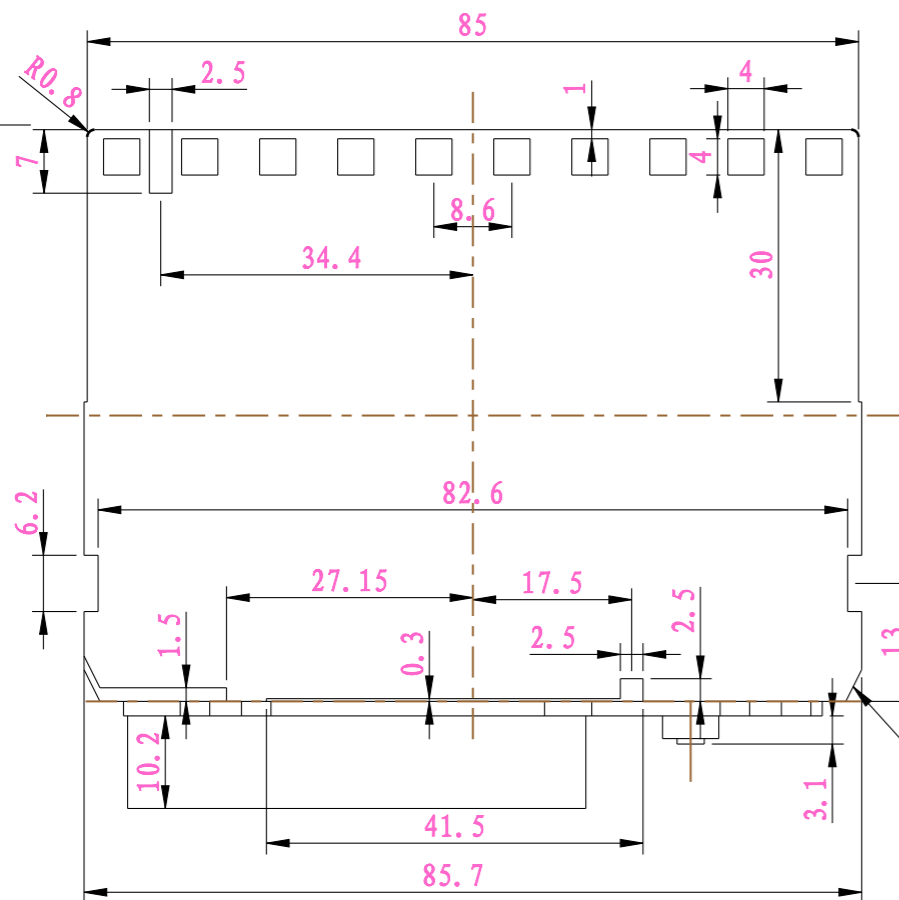

比例 1:1

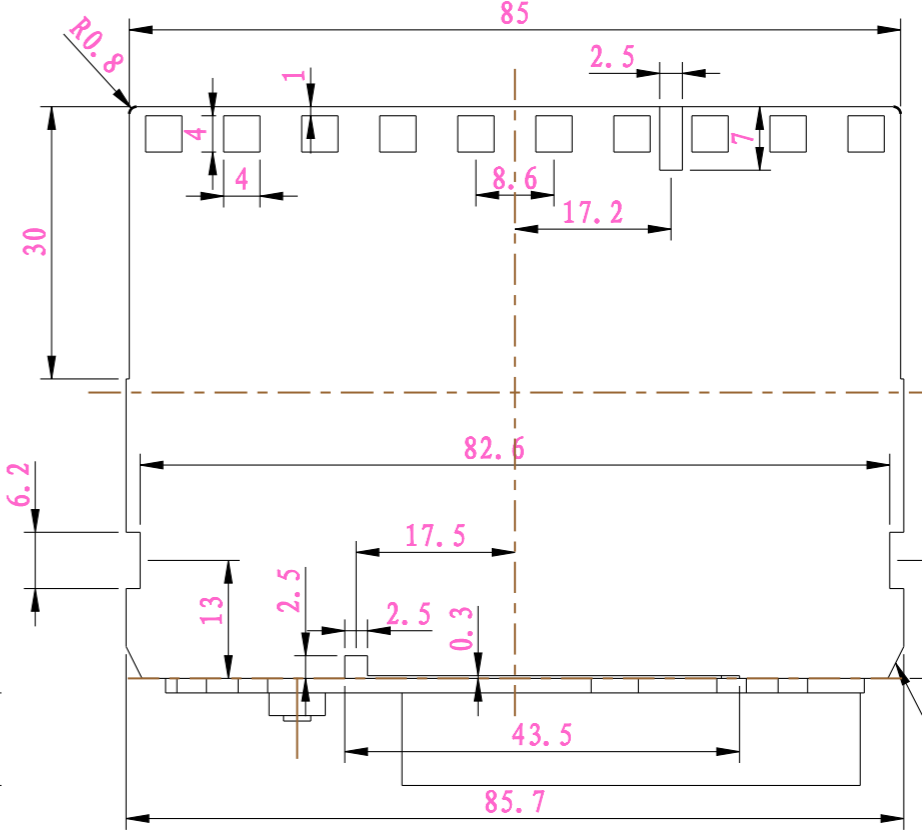

倒角1.75*3.5

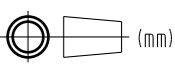

倒角1.75*3.5

制图 Drawing	审核 Auditing	批准 Confirm	客户名称 Custom Name	本厂开发	材料 Material		
胡鑫波			产品名称 Product Name	线路板	图纸比例 Drawing Scale	6:5	A3
11-09-09			产品编号 Product Code	96122-XLB	视图 Project View	 (mm)	
共 1 页		第 1 页		 宁波三和壳体公司 NINGBO SANHE ENCLOSURE CORPORATION		中国宁波慈溪 TEL: +86(574)63226910 FAX: +86(574)63226900	