



SENSOR SWITCH

Item #	RBS3303 Series	Description	TILT SWITCH	Version	V99.0
Page	1 of 10		Date	April 9, 2010	

● FUNCTIONS

1. Tilt Detecting within a 360° radius
2. Slight Vibration Detecting



● APPLICATIONS

1. LCD monitor rotation
2. Home appliance tilt-off function
3. Earthquake alarm
4. Automotive devices
5. Visual devices
6. Information devices
7. Communication devices

● FEATURES

1. Housing made of high insulation plastic material, free from electric conduction and rust problem.
2. Detecting with photo transistors, generating highly reliable and stable signals.
3. All plastic materials subject to industrial purpose, resist high temperature and meet fireproof function.
4. Simple ON and OFF signals, easy for design.
5. Suitable to horizontal PCB.
6. Tilt Angles: 15°, 20°, 30°, and 45° within a 360 ° radius.
7. RoHS compliance, an ideal substitute for mercury switch.
8. A more economical tilt and vibration detection option than IC design solution.
9. All made in Taiwan and examined before shipment.

● PATENTS

1. TAIWAN Patent NO. 181431
2. CHINA Patent NO. ZL 01 2 60920.X
3. U.S.A. Patent NO. US 6,800,841 B1



SENSOR SWITCH

Item #	RBS3303 Series	Description	TILT SWITCH	Version	V99.0
Page	2 of 10		Date	April 9, 2010	

● DIMENSIONS / OPERATION / P.C.B. LAYOUT (Unit: mm, Tolerance: $\pm 0.25\text{mm}$)

<p>RBS 33 03 10</p>	<p>Tilt Angle For $45^\circ \pm 10^\circ$</p>	<p>P.C.B. Layout (DIP)/Top View</p>
<p>Installation Position</p>	<p>Application Circuit</p>	
	<p>1. $V_{ce} = 5\text{V}$ 2. $R_D = 430\text{ohm}$ 3. $R_L = 33\text{Kohm}$</p>	



SENSOR SWITCH

Item #	RBS3303 Series	Description	TILT SWITCH	Version	V99.0
Page	3 of 10		Date	April 9, 2010	

<p>RBS 33 03 11</p>	<p>Tilt Angle For $30^{\circ} \pm 10^{\circ}$</p>	<p>P.C.B. Layout (DIP)/Top View</p>
<p>Installation Position</p>	<p>Application Circuit</p>	
	<ul style="list-style-type: none"> 1. $V_{ce} = 5V$ 2. $R_D = 430\Omega$ 3. $R_L = 33K\Omega$ 	



SENSOR SWITCH

Item #	RBS3303 Series	Description	TILT SWITCH	Version	V99.0
Page	4 of 10		Date	April 9, 2010	

<p>RBS 33 03 12</p>	<p>Tilt Angle For $20^{\circ} \pm 10^{\circ}$</p> <p> ■ Uncertain ($10^{\circ} \sim 30^{\circ}$) ($-10^{\circ} \sim -30^{\circ}$) ▨ Lo district ($0^{\circ} \sim 10^{\circ}$) ($0^{\circ} \sim -10^{\circ}$) □ Hi district ($30^{\circ} \sim 180^{\circ}$) ($-30^{\circ} \sim -180^{\circ}$) </p>	<p>P.C.B. Layout (DIP)/Top View</p>
<p>Installation Position</p>	<p>Application Circuit</p>	
	<p> 1. $V_{ce} = 5V$ 2. $R_D = 430\Omega$ 3. $R_L = 33K\Omega$ </p>	



SENSOR SWITCH

Item #	RBS3303 Series	Description	TILT SWITCH	Version	V99.0
Page	5 of 10		Date	April 9, 2010	

<p>RBS 33 03 13</p>	<p>Tilt Angle For $15^\circ \pm 10^\circ$</p> <ul style="list-style-type: none"> Uncertain ($5^\circ \sim 25^\circ$) ($-5^\circ \sim -25^\circ$) Lo district ($0^\circ \sim 5^\circ$) ($0^\circ \sim -5^\circ$) Hi district ($25^\circ \sim 180^\circ$) ($-25^\circ \sim -180^\circ$) 	<p>P.C.B. Layout (DIP)/Top View</p>
<p>Installation Position</p>	<p>Application Circuit</p>	
	<ul style="list-style-type: none"> 1. $V_{ce} = 5V$ 2. $R_D = 430\Omega$ 3. $R_L = 33K\Omega$ 	

● Device Selection Guide

Input Current (mA)	Operating Voltage (V)
10	5



SENSOR SWITCH

Item #	RBS3303 Series	Description	TILT SWITCH	Version	V99.0
Page	6 of 10		Date	April 9, 2010	

● Absolute Maximum Rating (Ta=25°C)

	Item	Symbol	Rating	Unit
Input	Power Dissipation	Pd	75	mW
	Reverse Voltage	Vr	5	V
	Forward Current	I _F	50	mA
	Peak Forward Current (*1)	I _{FP}	1	A
Output	Collector Power Dissipation	Pc	100	mW
	Collector Current	Ic	20	mA
	C-E Voltage	V _{CEO}	30	V
	E-C Voltage	V _{ECO}	5	V
Operating Temperature		Topr	-25~+85	°C
Storage Temperature		Tstg	-40~+100	°C
Soldering Temperature (*2)		Tsol	260	°C

(*1) tw=100 uSec. 、T=10 mSec.

(*2) t=5 Sec

● MECHANICAL CHARACTERISTICS

1.	Temperature Range	Operating: -25°C to +85°C Storage: -40°C to +85°C
2.	Pull Force of Terminal	500 gf for 1 minute
3.	Operation Life	30,000 hrs.
4.	Humidity	95% RH, 40°C for 96 hrs.
5.	Solder Ability	After flux 260±5°C for 5±0.5 seconds 95% coverage



SENSOR SWITCH

Item #	RBS3303 Series	Description	TILT SWITCH	Version	V99.0
Page	7 of 10		Date	April 9, 2010	

● **Electrical Optical Characteristics (Ta=25°C)**

Parameter	Symbol	Condition	Min.	Typ.	Max.	Unit
Forward Voltage	V_F	$I_F=20mA$	—	—	1.5	V
Reverse Current	I_R	$V_R=5V$	—	—	10	μA
Peak Wavelength	λ_p	$I_F=10mA$		940		nm
Dark Current	I_D	$V_{CE}=10V$	—	—	2	μA
C-E Saturation Voltage	$V_{CE(sat)}$	$I_C=0.25mA$ $I_F=20mA$	—	—	0.4	V
Light Current	I_L	$V_{CE}=5V$ $I_F=20mA$	0.5	5	—	mA
Rise Time	T_r	$I_C=0.8mA$ $V_{CC}=30v$	—	5	—	μsec
Fall Time	T_f	$R_L=1K\Omega$	—	5	—	μsec

● **BILL OF MATERIAL**

1.	Housing	Polyamide + Glass-Fiber
2.	Base	Polyamide + Glass-Fiber
3.	Ball	Stainless Steel
4.	Infrared Emitting Diodes	
5.	Silicon Photo Transistors	
6.	Inside Part	Copper Alloy, Nickel Plated



SENSOR SWITCH

Item #	RBS3303 Series	Description	TILT SWITCH	Version	V99.0
Page	8 of 10		Date	April 9, 2010	

● Typical Electrical / Optical Characteristics Curves (Ta=25°C)

Fig.1 Power Dissipation vs. Ambient Temperature

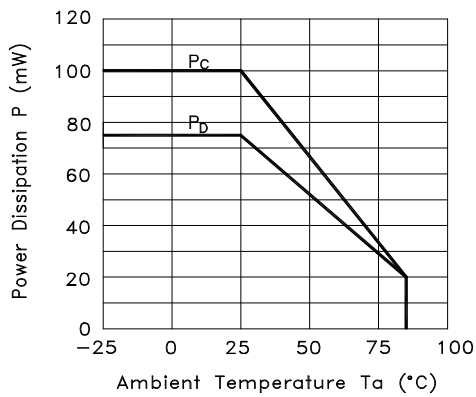

Fig.2 Forward Current vs. Forward Voltage

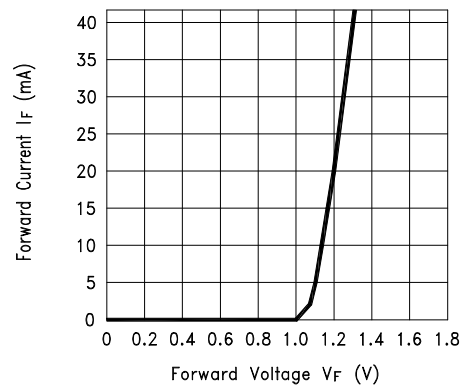

Fig.3 Collector Current vs. Collector-emitter Voltage

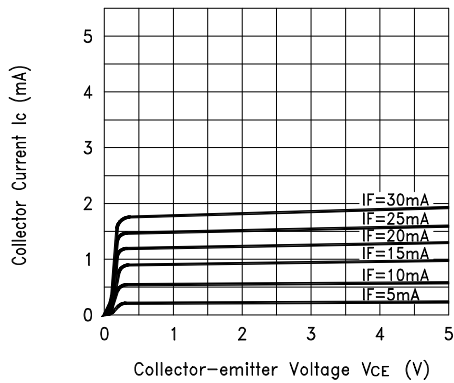
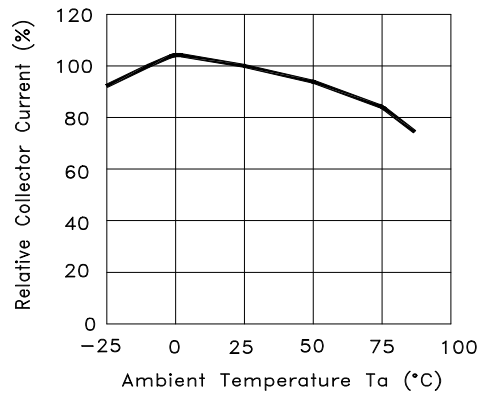

Fig.4 Collector Current vs. Ambient Temperature





SENSOR SWITCH

Item #	RBS3303 Series	Description	TILT SWITCH	Version	V99.0
Page	9 of 10		Date	April 9, 2010	

Fig.5 Collector-emitter Saturation Voltage vs. Ambient Temperature

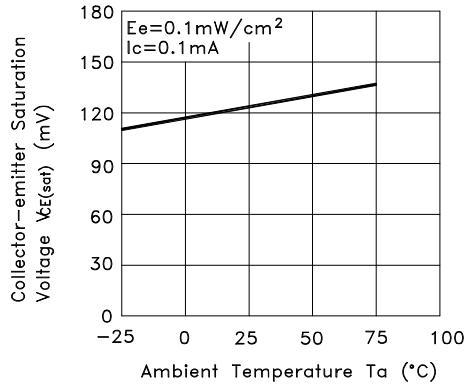

Fig.6 Response Time vs. Load Resistance

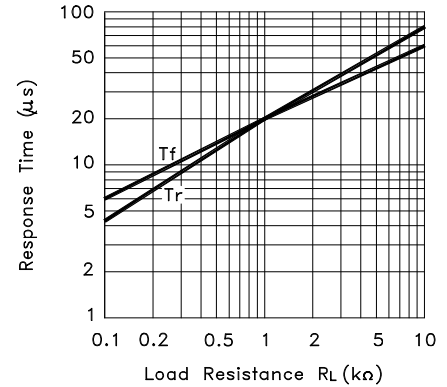
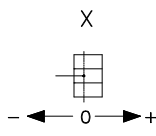
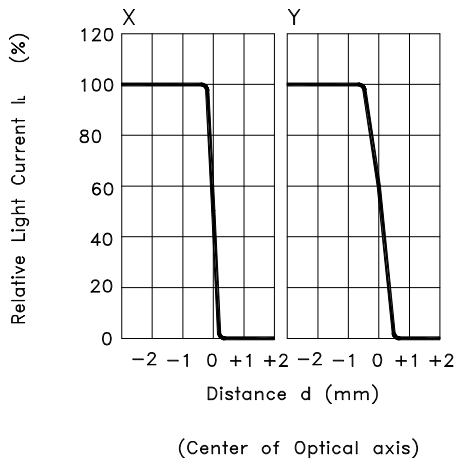
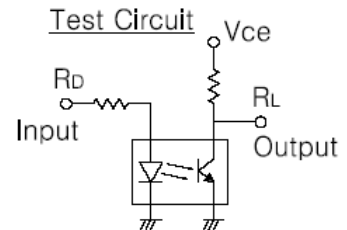
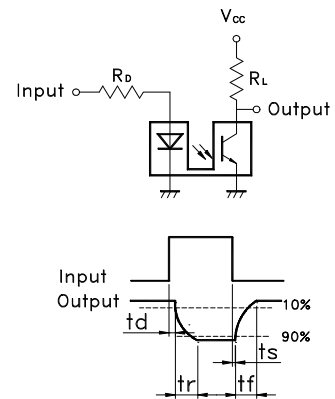

Fig.7 Sensing Position Characteristics (Typical)



Test Circuit for Response Time





SENSOR SWITCH

Item #	RBS3303 Series	Description	TILT SWITCH	Version	V99.0
Page	10 of 10		Date	April 9, 2010	

● PACKAGE

	Part Number	Package	Quantity	Total	Size
1.	RBS330310	PE Bag	250 pcs	250 pcs	12.7 x 17.8 (cm)
	RBS330311	Inner Box	8 PE Bag	2,000 pcs	36 x 20 x 9 (cm)
	RBS330312				
	RBS330313	Carton	3 Boxes	6,000 pcs	36 x 28 x 23 (cm)
2.	RBS330310	IC tube	48 pcs	48 pcs	52.5 x 1 x 1.76 (cm)
	RBS330311	Inner Box	84 tubes	4,032 pcs	54 x 13 x 13 (cm)
	RBS330312				
	RBS330313	Carton	4 Boxes	16,128 pcs	55 x 29 x 29 (cm)

* Minimum Order Quantity: One Bag / One Box (84 tubes)

● NOTE

For the continued product improvement as one of the company policy, specifications may change or update without notice. The latest information can be obtained through our sales offices. Normally, all products are supplied under our standard conditions.

● PRECAUTIONS FOR USE

1. If the products is intended to be used for other endurance equipments requiring higher safety and reliability such as life support system, space and aviations devices, disaster and safety system, it's necessary to make verification of conformity or contact us for the details before using.
2. Don't try to clean the switch with a solvent or similar substance after the soldering process.
3. The switch might be damaged if using the water-soluble flux.