

## Photo DMOS-FET Relay

### Description

The **LT238** is a miniature 1-Form A solid state relay in a 4 pin SOP package featuring low C×R .That employs optically coupled MOSFET technology to provide 1500V of input to output isolation. The optically coupled input is controlled by a highly efficient GaAlAs infrared LED and MOS FETs on the output side.

### Features

- SOP package 4 Pin type in miniature design (4.4×4.3×2.0mm / .173×.169×.083inch)
- Low driver power requirements (TTL/CMOS Compatible)
- **Low C : Output capacitance=28pF(Typ.)**
- **Low R : On-Resistance=0.8Ω(Typ.) , Off-State leakage current= 10nA(Max.)**
- No moving parts ,High reliability
- Arc-Free with no snubbing circuits
- 1500Vrms Input/Output isolation
- Tape & Reel version available

### Applications

- Telecommunications (PC, Electronic notepad)
- Measuring and Testing equipment
- Industrial control
- Security equipments
- High speed inspection machine

### Outline Dimensions

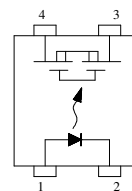
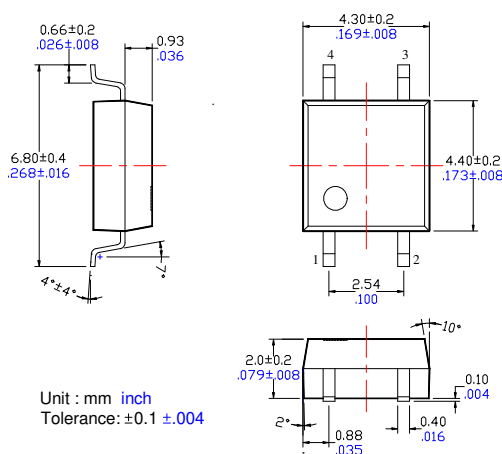

1. LED Anode
2. LED Cathode
- 3, 4. Drain (MOS FET)

## Photo DMOS-FET Relay Specifications

### Part Name: LT238

(Load voltage: 60V / Load current: 500mA)

#### Absolute Maximum Ratings (Ambient Temperature: 25°C)

Item	Symbol	Value	Units	Note	
Input	Continuous LED Current	I <sub>F</sub>	50	mA	
	Peak LED Current	I <sub>FP</sub>	1000	mA	f=100Hz, duty=1%
	LED Reverse Voltage	V <sub>R</sub>	5	V	
	Input Power Dissipation	P <sub>In</sub>	75	mW	
Output	Load Voltage	V <sub>L</sub>	60	V(AC peak or DC)	
	Load Current	I <sub>L</sub>	500	mA	
	Peak Load Current	I <sub>Peak</sub>	1.0	A	100ms(1 pulse)
	Output Power Dissipation	P <sub>out</sub>	300	mW	
Total Power Dissipation		P <sub>T</sub>	350	mW	
I/O Breakdown Voltage		V <sub>I/O</sub>	1500	V <sub>rms</sub>	RH=60%, 1min
Operating Temperature		T <sub>opr</sub>	-40 to +85	°C	
Storage Temperature		T <sub>stg</sub>	-40 to +100	°C	
Pin Soldering Temperature		T <sub>sol</sub>	260	°C	10 sec max.

#### Electrical Specifications (Ambient Temperature: 25°C)

Item	Symbol	MIN.	TYP.	MAX.	Units	Conditions
Input	LED Forward Voltage	V <sub>F</sub>	1.2	1.5	V	I <sub>F</sub> =10mA
	Operation LED Current	I <sub>F on</sub>	0.5	2.0	mA	
	Recovery LED Current	I <sub>F off</sub>	0.1	0.35	mA	
	Recovery LED Voltage	V <sub>F off</sub>	0.7		V	
Output	On-Resistance	R <sub>on</sub>	0.8	1.5	Ω	I <sub>F</sub> =5mA, I <sub>L</sub> =100mA, Time to flow is within 1 sec.
	Off-State Leakage Current	I <sub>Leak</sub>	1	10	nA	V <sub>L</sub> =Rating
	Output Capacitance	C <sub>out</sub>	28		pF	V <sub>L</sub> =0, f=1MHz
Transmission	Turn-On Time	T <sub>on</sub>	0.25	0.35	ms	I <sub>F</sub> =5mA, I <sub>L</sub> =100mA,
	Turn-Off Time	T <sub>off</sub>	0.02	0.05	ms	
Coupled	I/O Isolation Resistance	R <sub>I/O</sub>	10 <sup>10</sup>		Ω	DC500V
	I/O Capacitance	C <sub>I/O</sub>	0.8	1.5	pF	f=1MHz

## Reference Data

Load current Vs. Ambient temperature

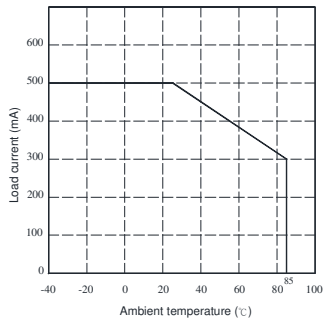

On resistance Vs. Ambient temperature

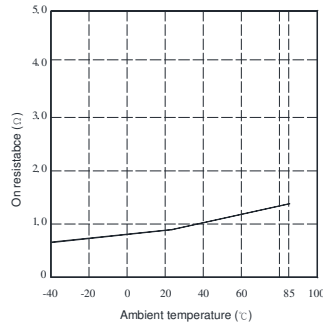

Turn on time Vs. Ambient temperature

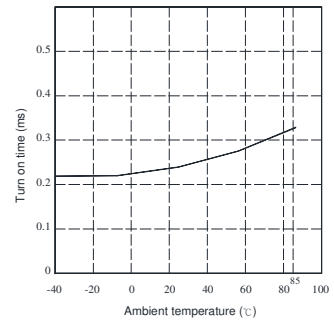

Turn off time Vs. Ambient temperature

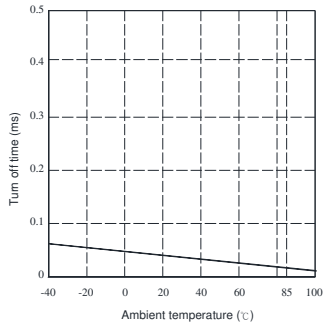

LED operate current Vs. Ambient temperature

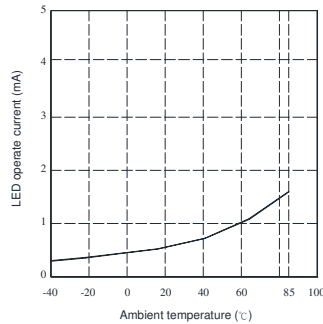

LED turn off current Vs. Ambient temperature

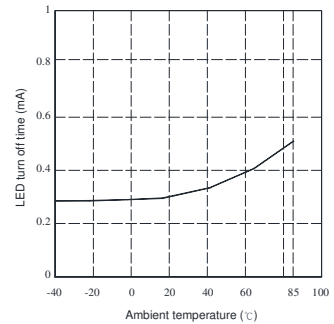

LED forward voltage Vs. Ambient temperature

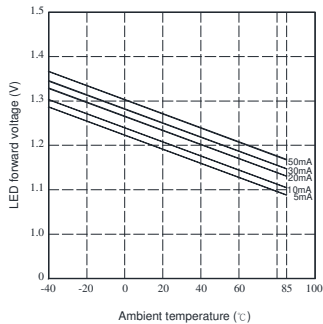

Voltage Vs. current characteristics of output at MOS portion

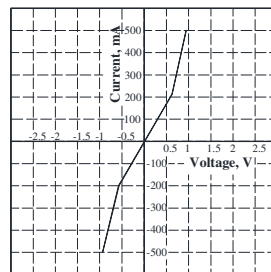

Off state leakage current Vs. Load voltage characteristics

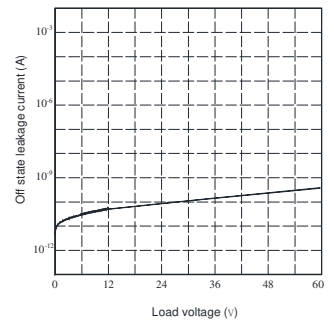

LED forward current Vs. turn on time characteristics

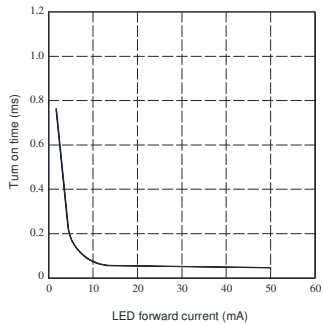

LED forward current Vs. turn off time characteristics

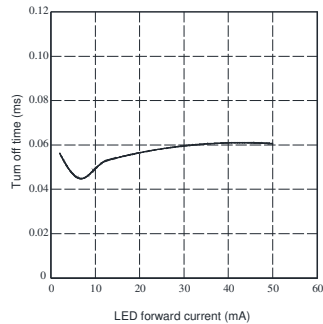

Applied voltage Vs. output capacitance characteristics

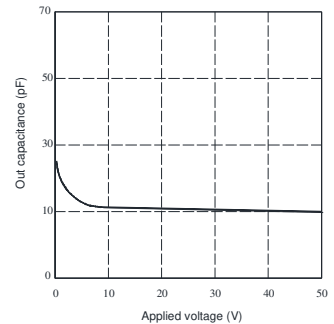

## Taping Specifications for Surface Mount Devices

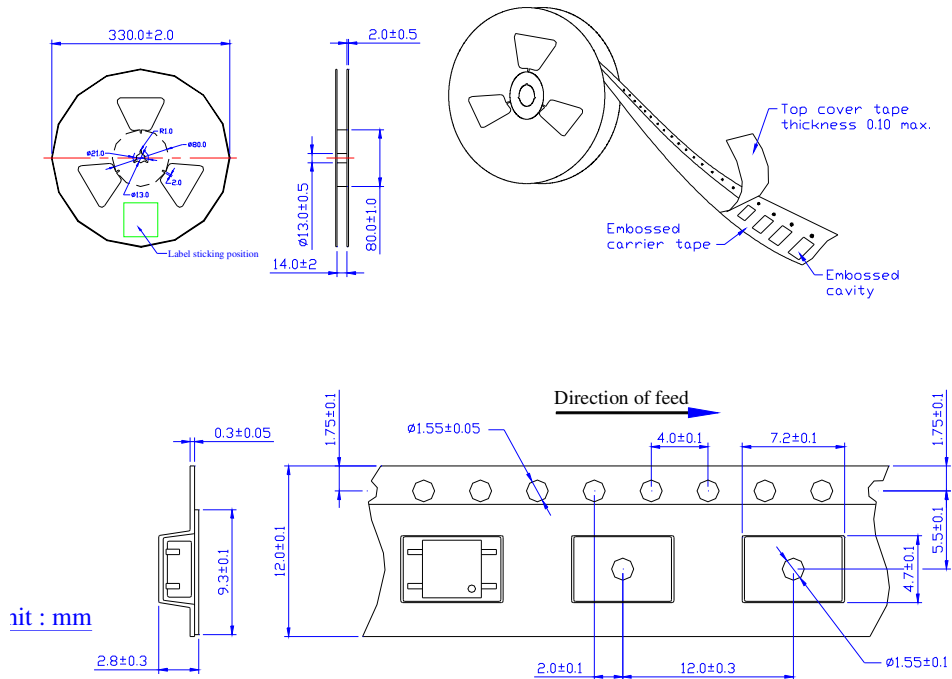

### Recommended Mounting Pad

(Top view)

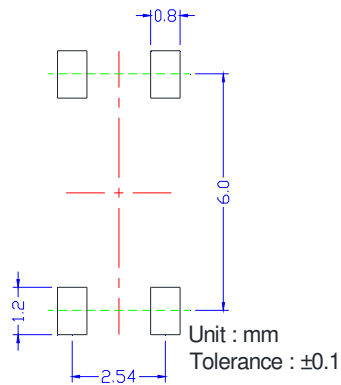

### Marking

(Each photo MOS Relay shall be marked with the following information)

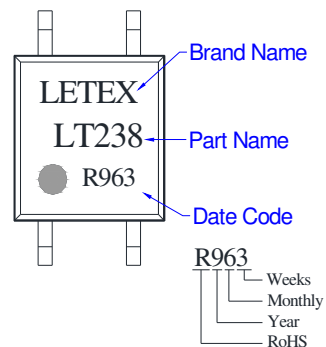

- Note:
1. There shall be leader of 230 mm minimum which may consist of carrier and or cover tape follower by a minimum of 160 mm of carrier tape sealed with cover tape.
  2. There shall be a minimum of 160 mm of empty component pockets sealed with cover tape.
  3. Devices are pockets in accordance with EIA standard EIA-481-A and specifications given above.
  4. Packaging: 2,000pcs per reel, 2 reel per box, 5 boxes per carton.