

Photo DMOS-FET Relay

Description

The **LT321RS** is a miniature 2-Form A solid state relay in a 8 pin SOP package that employs optically coupled MOSFET technology to provide 1500V of input to output isolation. The optically coupled input is controlled by a highly efficient GaAlAs infrared LED and MOS FETs on the output side.

Features

- SOP package 8 Pin type in miniature design (4.4×9.4×2.0mm / .173×.37×.083inch)
- Low driver power requirements (TTL/CMOS Compatible)
- No moving parts
- High reliability
- Arc-Free with no snubbing circuits
- 1500Vrms Input/Output isolation
- Tape & Reel version available
- **Low Output Capacitance**

Applications

- Telecommunications (PC, Electronic notepad)
- Measuring and Testing equipment
- Industrial control
- Security equipments
- High speed inspection machine

Outline Dimensions

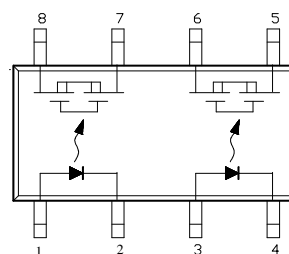
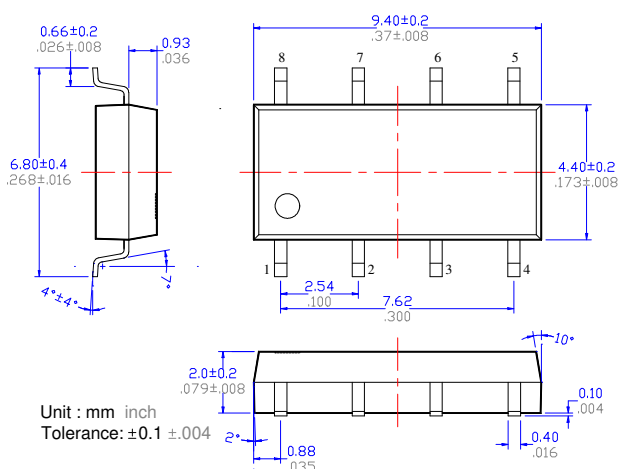

- 1,3. LED Anode
- 2,4. LED Cathode
- 5,6. Drain (MOS FET)
- 7,8. Drain (MOS FET)

Photo DMOS-FET Relay Specifications

Part Name: LT321RS

(Load voltage: 40V / Load current: 200mA)

Absolute Maximum Ratings (Ambient Temperature: 25°C)

Item	Symbol	Value	Units	Note	
Input	Continuous LED Current	I _F	50	mA	
	Peak LED Current	I _{FP}	1000	mA	f=100Hz, duty=1%
	LED Reverse Voltage	V _R	5	V	
	Input Power Dissipation	P _{In}	75	mW	
Output	Load Voltage	V _L	40	V(AC peak or DC)	
	Load Current	I _L	200	mA	
	Peak Load Current	I _{Peak}	0.6	A	100ms(1 pulse)
	Output Power Dissipation	P _{out}	250	mW	
Total Power Dissipation	P _T	300	mW		
I/O Breakdown Voltage	V _{I/O}	1500	V _{rms}	RH=60%, 1min	
Operating Temperature	T _{Opr}	-40 to +85	°C		
Storage Temperature	T _{Stg}	-40 to +100	°C		
Pin Soldering Temperature	T _{Sol}	260	°C	10 sec max.	

Electrical Specifications (Ambient Temperature: 25°C)

Item	Symbol	MIN.	TYP.	MAX.	Units	Conditions
Input	LED Forward Voltage	V _F	1.2	1.4	V	I _F =10mA
	Operation LED Current	I _{F On}	0.5	3.0	mA	
	Recovery LED Current	I _{F Off}	0.1	0.35	mA	
	Recovery LED Voltage	V _{F Off}	0.7		V	
Output	On-Resistance	R _{On}	1.5	2.0	Ω	I _F =5mA, I _L = Rating, Time to flow is within 1 sec.
	Off-State Leakage Current	I _{Leak}		10	nA	V _L =Rating
	Output Capacitance	C _{Out}		5	pF	V _L =0, f=1MHz
Transmission	Turn-On Time	T _{On}	0.03	0.1	ms	I _F =5mA, I _L = Rating,
	Turn-Off Time	T _{Off}	0.1	0.3	ms	
Coupled	I/O Isolation Resistance	R _{I/O}	10 ¹⁰		Ω	DC500V
	I/O Capacitance	C _{I/O}		0.8	1.5	pF

Reference Data

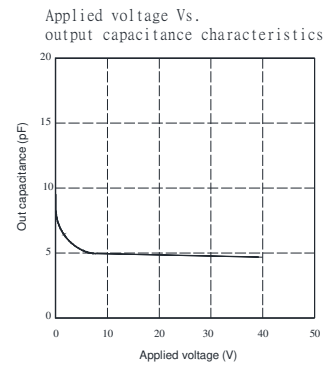
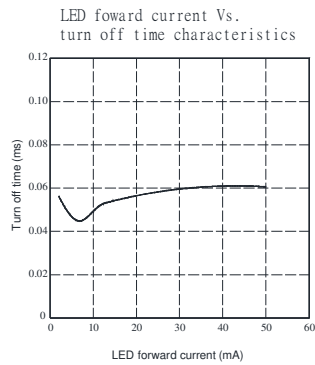
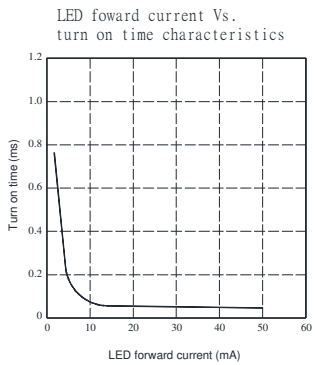
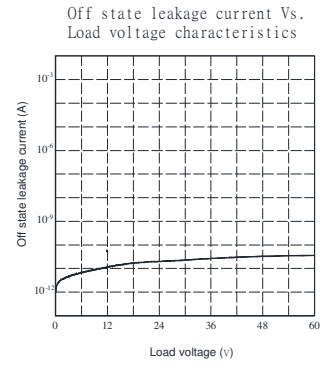
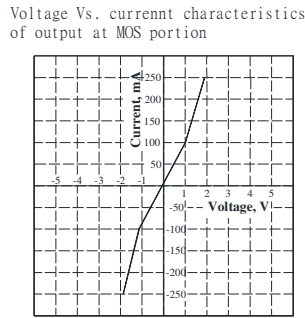
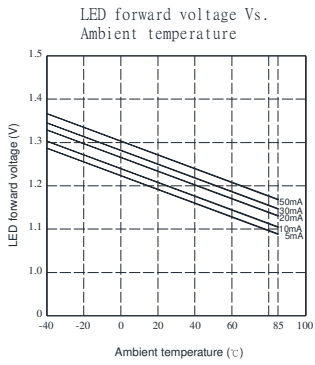
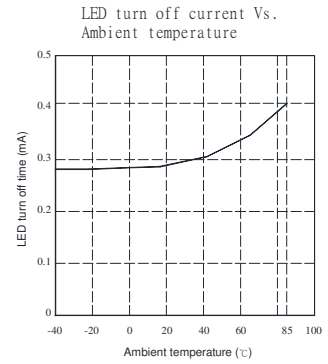
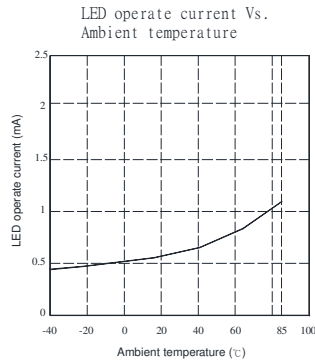
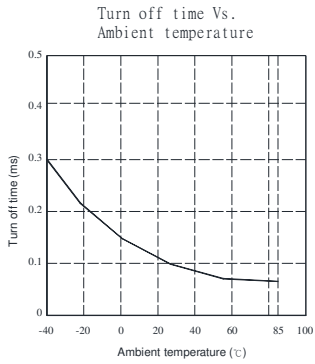
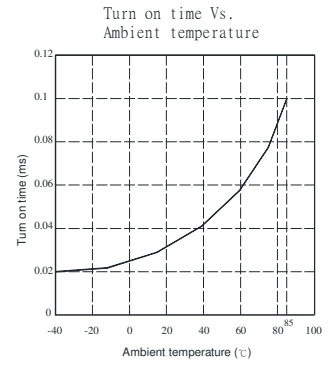
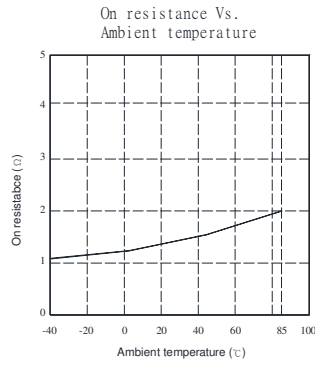
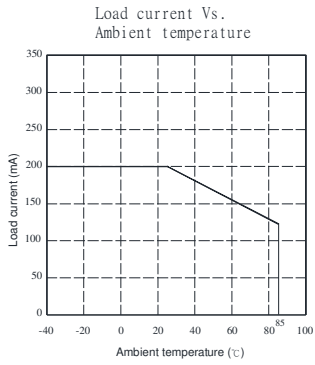

Taping Specifications for Surface Mount Devices

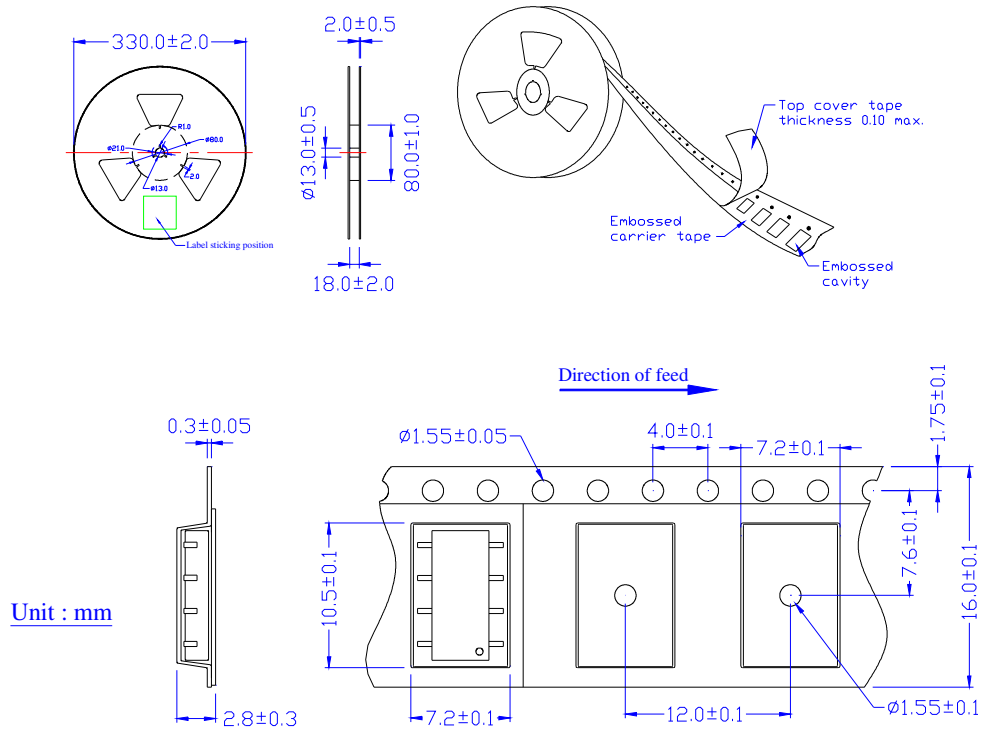

Unit : mm

Recommended Mounting Pad

(Top view)

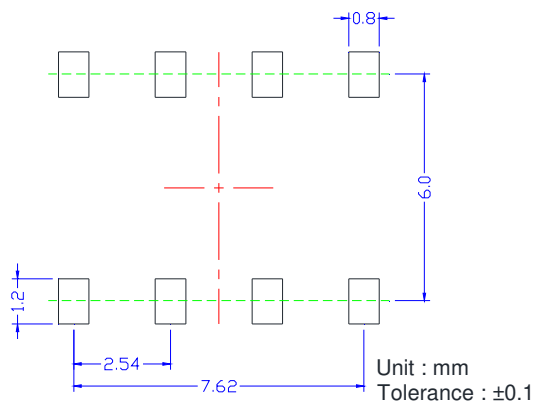

Marking

(Each photo MOS Relay shall be marked with the following information)

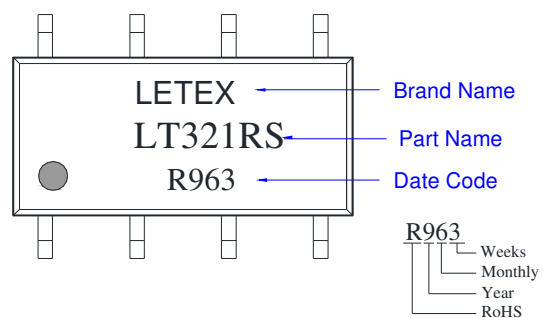

- Note:
1. There shall be leader of 230 mm minimum which may consist of carrier and or cover tape follower by a minimum of 160 mm of carrier tape sealed with cover tape.
 2. There shall be a minimum of 160 mm of empty component pockets sealed with cover tape.
 3. Devices are pockets in accordance with EIA standard EIA-481-A and specifications given above.
 4. Packaging: 1,000pcs per reel, 2 reel per box, 5 boxes per carton.