

## Photo DMOS-FET Relay

### Description

The **LT611** is a 1-Form A solid state relay in a 4 pin SMD package that employs optically coupled MOSFET technology to provide 3750V/5000V of input to output isolation. The optically coupled input is controlled by a highly efficient GaAlAs infrared LED and MOS FETs on the output side.

### Features

- Low driver power requirements (TTL/CMOS Compatible)
- High reliability
- Arc-Free with no snubbing circuits
- 3750/5000Vrms Input/Output isolation
- Tape & Reel version available

### Applications

- Telecommunications (PC, Electronic notepad)
- Measuring and Testing equipment
- Industrial control
- Security equipments
- High speed inspection machine

### Outline Dimensions

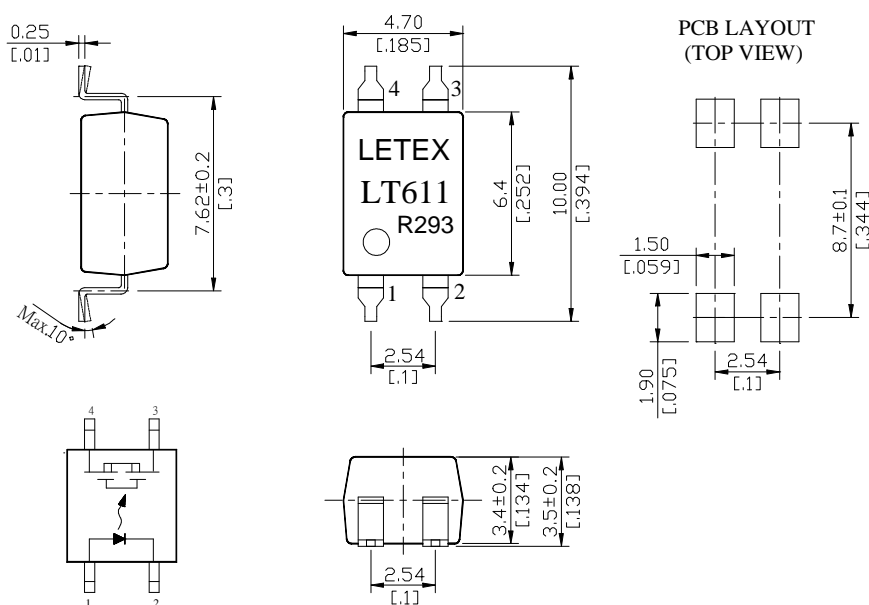

1. LED Anode
2. LED Cathode
3. Drain (MOS FET)
4. Drain (MOS FET)

Unit : mm [inch]  
Tolerance: ±0.2 [±.007]

## Photo DMOS-FET Relay Specifications

### Part Name: LT611

(Load voltage: 350V / Load current: 130mA)

#### Absolute Maximum Ratings (Ambient Temperature: 25°C)

Item		Symbol	Value	Units	Note
Input	Continuous LED Current	I <sub>F</sub>	50	mA	
	Peak LED Current	I <sub>FP</sub>	1000	mA	f=100Hz, uty=1%
	LED Reverse Voltage	V <sub>R</sub>	5	V	
	Input Power Dissipation	P <sub>In</sub>	75	mW	
Output	Load Voltage	V <sub>L</sub>	350	V(AC peak or DC)	
	Load Current	I <sub>L</sub>	130	mA	
	Peak Load Current	I <sub>Peak</sub>	0.6	A	100ms(1 pulse)
	Output Power Dissipation	P <sub>out</sub>	300	mW	
Total Power Dissipation		P <sub>T</sub>	350	mW	
I/O Breakdown Voltage		V <sub>I/O</sub>	3750	V <sub>rms</sub>	RH=60%, 1min
I/O Breakdown Voltage(Suffix-V)		V <sub>I/O</sub>	5000	V <sub>rms</sub>	RH=60%, 1min
Operating Temperature		T <sub>Opr</sub>	-40 to +85	°C	
Storage Temperature		T <sub>Stg</sub>	-40 to +100	°C	
Pin Soldering Temperature		T <sub>Sol</sub>	260	°C	10 sec max.

#### Electrical Specifications (Ambient Temperature: 25°C)

Item		Symbol	MIN.	TYP.	MAX.	Units	Conditions
Input	LED Forward Voltage	V <sub>F</sub>		1.2	1.5	V	I <sub>F</sub> =10mA
	Operation LED Current	I <sub>F On</sub>		0.5	5.0	mA	
	Recovery LED Current	I <sub>F Off</sub>		0.35	0.5	mA	
	Recovery LED Voltage	V <sub>F Off</sub>	0.5			V	
Output	On-Resistance	R <sub>On</sub>		17	24	Ω	I <sub>F</sub> =10mA, I <sub>L</sub> =100mA, Time to flow is within 1 sec.
	Off-State Leakage Current	I <sub>Leak</sub>			1	uA	V <sub>L</sub> =Rating
	Output Capacitance	C <sub>Out</sub>		41		pF	V <sub>L</sub> =0, f=1MHz
Transmis sion	Turn-On Time	T <sub>On</sub>		0.23	0.5	ms	I <sub>F</sub> =10mA, I <sub>L</sub> =100mA
	Turn-Off Time	T <sub>Off</sub>		0.05	0.2	ms	
Coupled	I/O Isolation Resistance	R <sub>I/O</sub>	10 <sup>10</sup>			Ω	DC500V
	I/O Capacitance	C <sub>I/O</sub>		0.8	1.5	pF	f=1MHz

## Reference Data

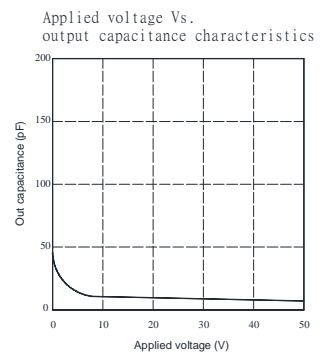
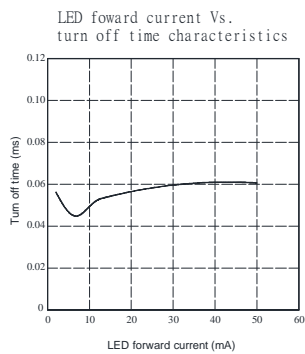
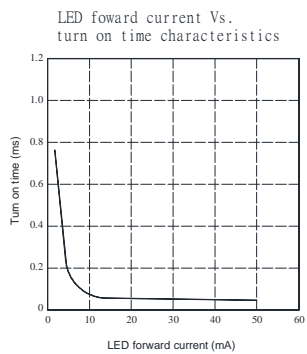
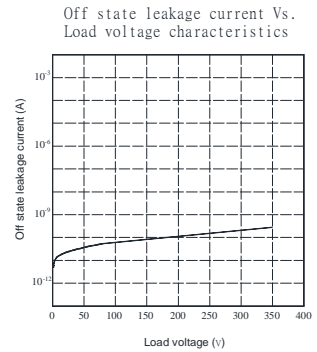
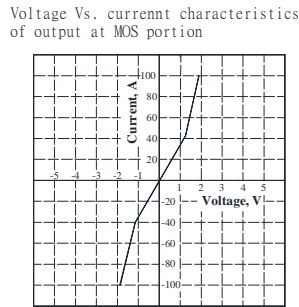
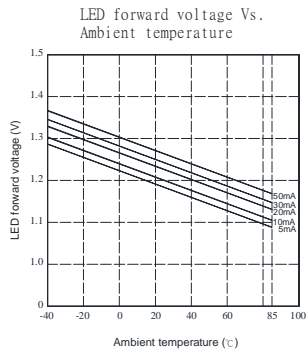
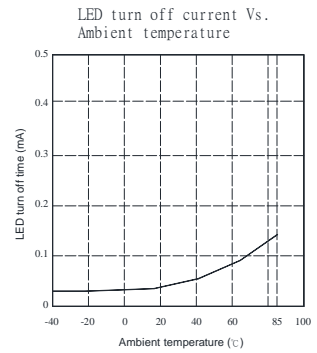
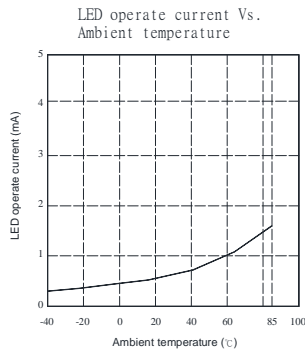
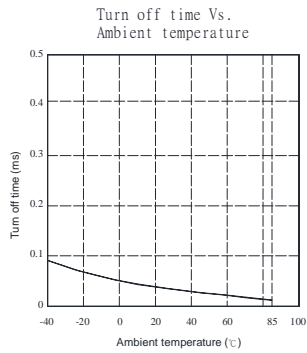
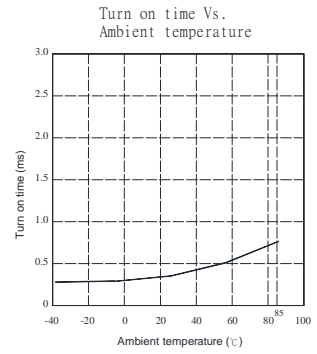
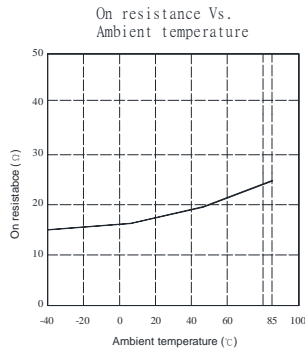
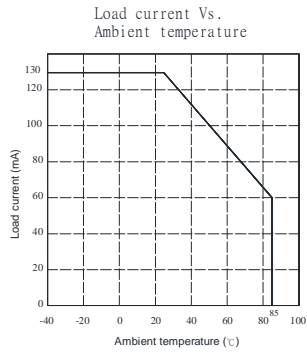

### Taping Specifications for Surface Mount Devices

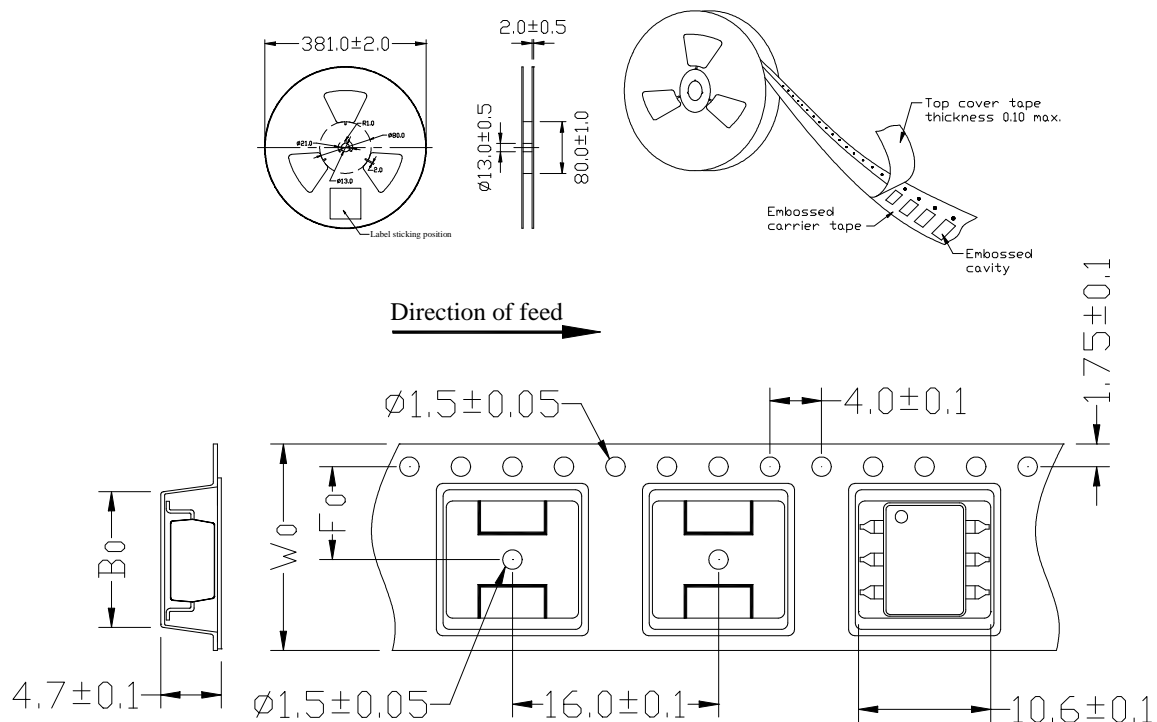

Unit: mm

TYPE	B0±0.1	F0±0.1	W0±0.1	15" REEL/PCS
4P	5.3	7.5	16	1000

### Recommended Mounting Pad

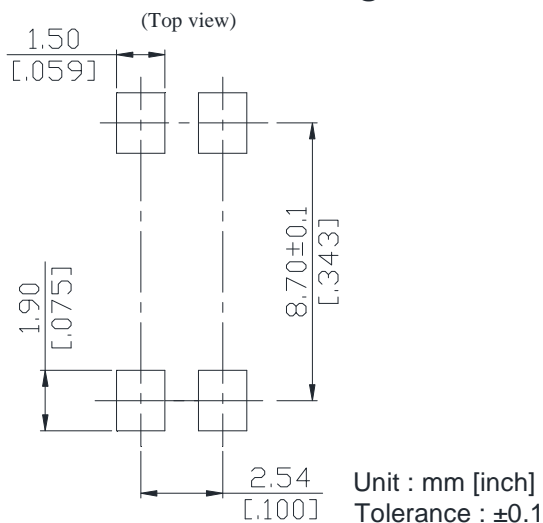

### Marking

(Each photo MOS Relay shall be marked with the following information)

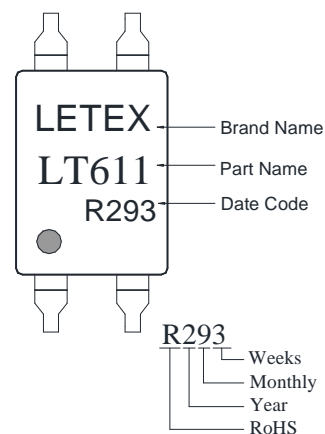

- Note: 1. There shall be leader of 230 mm minimum which may consist of carrier and or cover tape follower by a minimum of 160 mm of carrier tape sealed with cover tape.  
 2. There shall be a minimum of 160 mm of empty component pockets sealed with cover tape.  
 3. Devices are pockets in accordance with EIA standard EIA-481-A and specifications given above.