

Photo DMOS-FET Relay

Description

The **LT711** is a 2-Form A solid state relay in a 8 pin SMD package that employs optically coupled MOSFET technology to provide 3750V/5000V of input to output isolation. The optically coupled input is controlled by a highly efficient GaAlAs infrared LED and MOS FETs on the output side.

Features

- Low driver power requirements (TTL/CMOS Compatible)
- High reliability
- Arc-Free with no snubbing circuits
- 3750/5000Vrms Input/Output isolation
- Tape & Reel version available

Applications

- Telecommunications (PC, Electronic notepad)
- Measuring and Testing equipment
- Industrial control
- Security equipments
- High speed inspection machine

Outline Dimensions

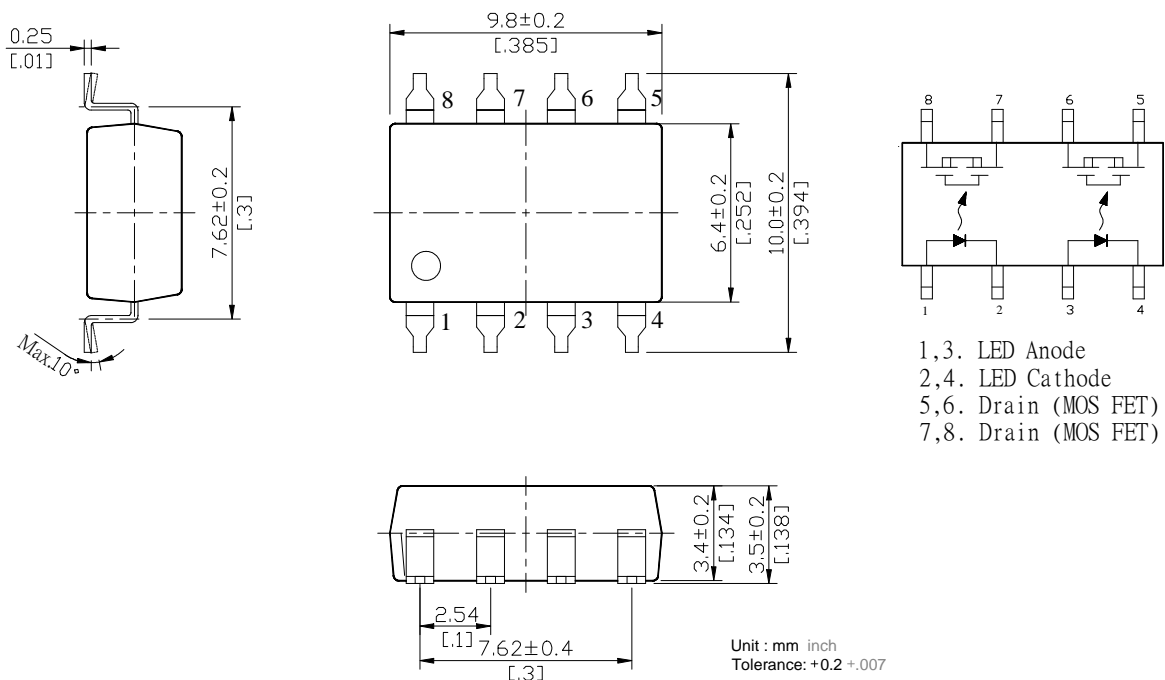

Photo DMOS-FET Relay Specifications

Part Name: LT711

(Load voltage: 350V / Load current: 130mA)

Absolute Maximum Ratings (Ambient Temperature: 25°C)

| Item | | Symbol | Value | Units | Note |
|---------------------------------|--------------------------|-------------------|-------------|------------------|---------------------|
| Input | Continuous LED Current | I _F | 50 | mA | |
| | Peak LED Current | I _{FP} | 1000 | mA | f=100Hz, duty=1% |
| | LED Reverse Voltage | V _R | 5 | V | |
| | Input Power Dissipation | P _{In} | 75 | mW | |
| Output | Load Voltage | V _L | 350 | V(AC peak or DC) | |
| | Load Current | I _L | 130 | mA | |
| | Peak Load Current | I _{Peak} | 0.6 | A | 100ms(1 pulse) |
| | Output Power Dissipation | P _{out} | 300 | mW | |
| Total Power Dissipation | | P _T | 350 | mW | |
| I/O Breakdown Voltage | | V _{I/O} | 3750 | V _{rms} | RH=60%, 1min |
| I/O Breakdown Voltage(Suffix-V) | | V _{I/O} | 5000 | V _{rm} | RH=60%, 1min |
| Operating Temperature | | T _{Opr} | -40 to +85 | °C | |
| Storage Temperature | | T _{Stg} | -40 to +100 | °C | |
| Pin Soldering Temperature | | T _{Sol} | 260 | °C | 10 sec max. |

Electrical Specifications (Ambient Temperature: 25°C)

| Item | | Symbol | MIN. | TYP. | MAX. | Units | Conditions |
|--------------|---------------------------|--------------------|------------------|------|------|-------|--|
| Input | LED Forward Voltage | V _F | | 1.2 | 1.5 | V | I _F =10mA |
| | Operation LED Current | I _{F On} | | 0.5 | 5.0 | mA | |
| | Recovery LED Current | I _{F Off} | | 0.35 | 0.5 | mA | |
| | Recovery LED Voltage | V _{F Off} | 0.5 | | | V | |
| Output | On-Resistance | R _{On} | | 17 | 24 | Ω | I _F =10mA, I _L =100mA, Time to flow is within 1 sec. |
| | Off-State Leakage Current | I _{Leak} | | | 1 | uA | V _L =Rating |
| | Output Capacitance | C _{Out} | | 41 | | pF | V _L =0, f=1MHz |
| Transmission | Turn-On Time | T _{On} | | 0.23 | 0.5 | ms | I _F =10mA, I _L =100mA, |
| | Turn-Off Time | T _{Off} | | 0.03 | 0.2 | ms | |
| Coupled | I/O Isolation Resistance | R _{I/O} | 10 ¹⁰ | | | Ω | DC500V |
| | I/O Capacitance | C _{I/O} | | 0.8 | 1.5 | pF | f=1MHz |

Reference Data

Load current Vs. Ambient temperature

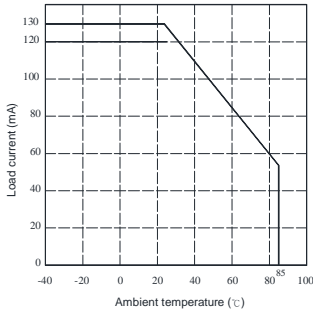

On resistance Vs. Ambient temperature

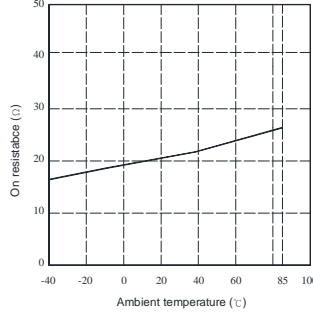

Turn on time Vs. Ambient temperature

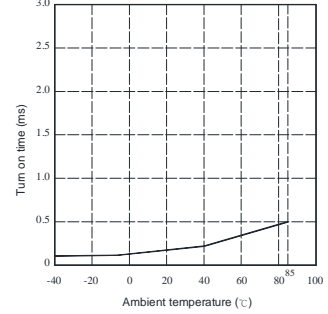

Turn off time Vs. Ambient temperature

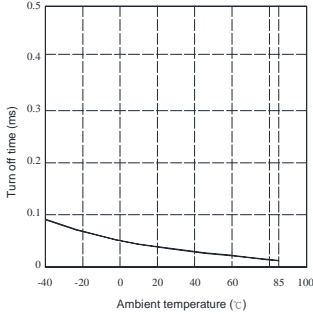

LED operate current Vs. Ambient temperature

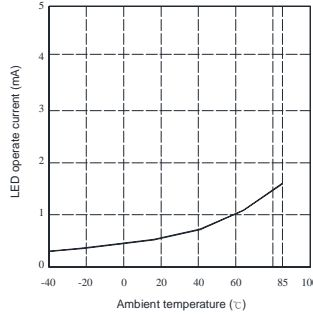

LED turn off current Vs. Ambient temperature

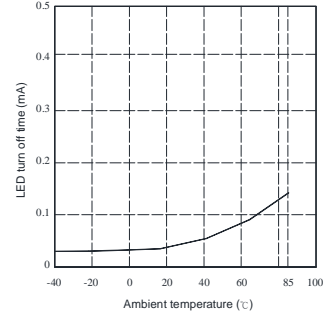

LED forward voltage Vs. Ambient temperature

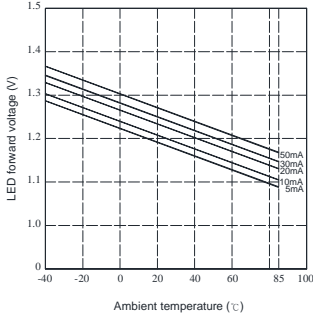

Voltage Vs. current characteristics of output at MOS portion

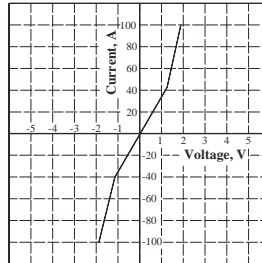

Off state leakage current Vs. Load voltage characteristics

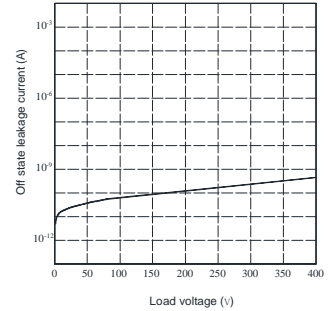

LED forward current Vs. turn on time characteristics

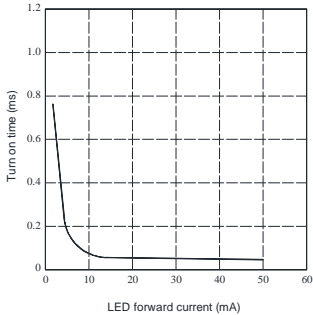

LED forward current Vs. turn off time characteristics

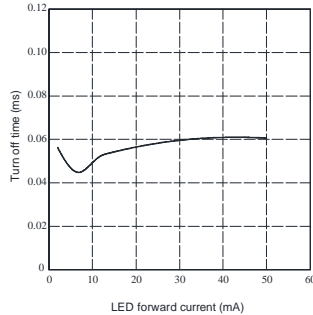

Applied voltage Vs. output capacitance characteristics

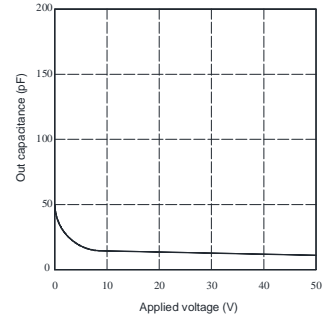

Taping Specifications for Surface Mount Devices

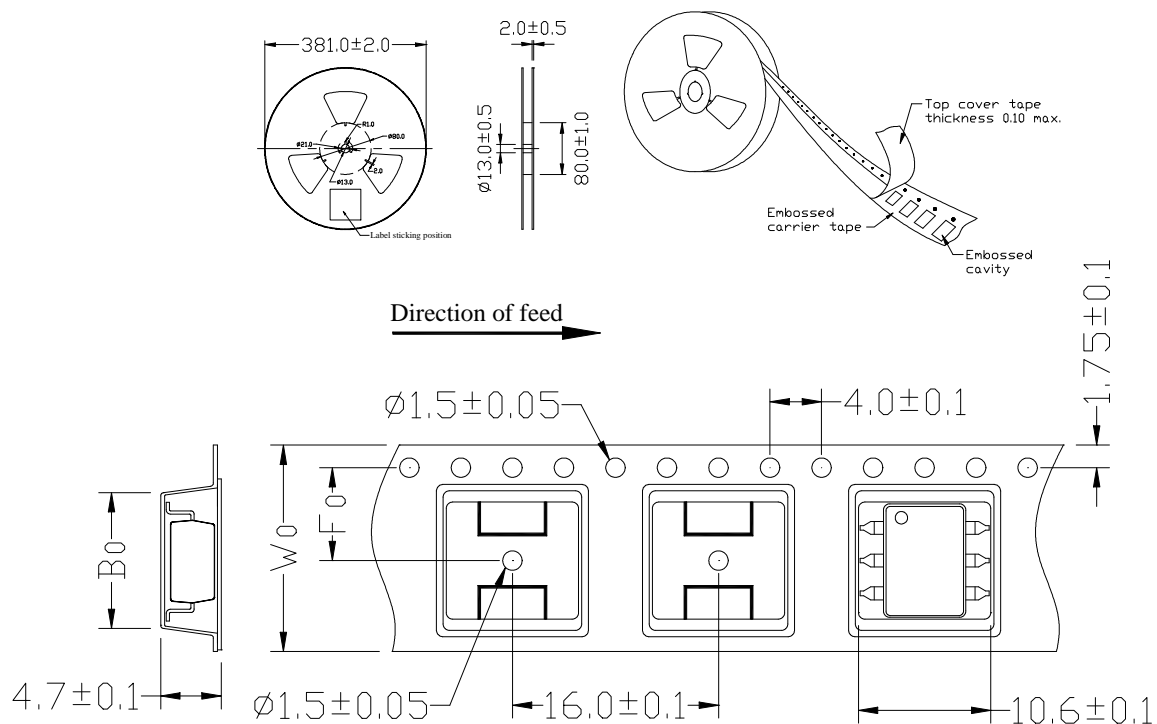

Unit: mm

| TYPE | B0±0.1 | F0±0.1 | W0±0.1 | 15"REEL/PCS |
|------|--------|--------|--------|-------------|
| 8P | 10.3 | 11.5 | 24 | 1000 |

Recommended Mounting Pad

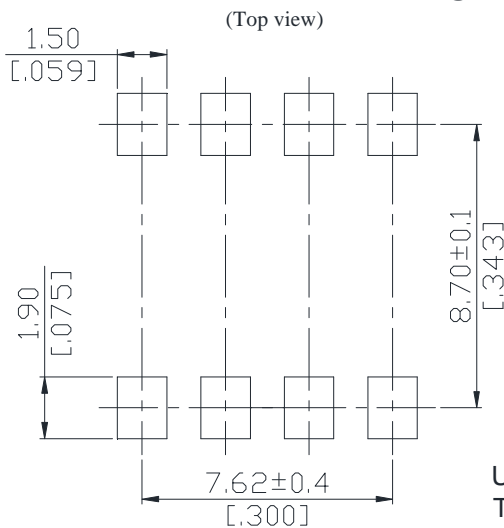

Unit : mm [inch]
Tolerance : ±0.1

Marking

(Each photo MOS Relay shall be marked with the following information)

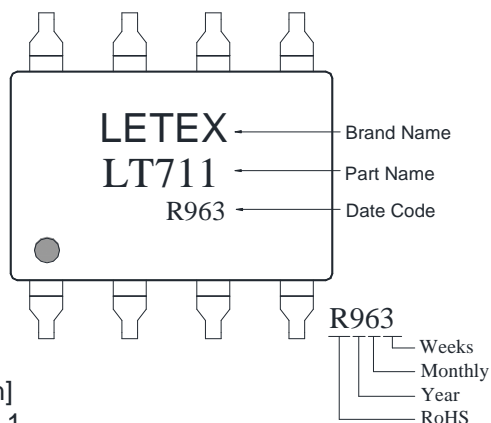

- Note: 1. There shall be leader of 230 mm minimum which may consist of carrier and or cover tape follower by a minimum of 160 mm of carrier tape sealed with cover tape.
 2. There shall be a minimum of 160 mm of empty component pockets sealed with cover tape.
 3. Devices are pockets in accordance with EIA standard EIA-481-A and specifications given above.