

Photo DMOS-FET Relay

Description

The **LT716** is a 2-Form A solid state relay in an 8 pin SMD package that employs optically coupled MOSFET technology to provide 3750V of input to output isolation. The optically coupled input is controlled by a highly efficient GaAlAs infrared LED and MOS FETs on the output side.

Features

- Low driver power requirements (TTL/CMOS Compatible)
- No moving parts
- High reliability
- Arc-Free with no snubbing circuits
- 3750Vrms Input/Output isolation

Applications

- Telecommunications (PC, Electronic notepad)
- Measuring and Testing equipment
- Industrial control
- Security equipments
- High speed inspection machine

Outline Dimensions

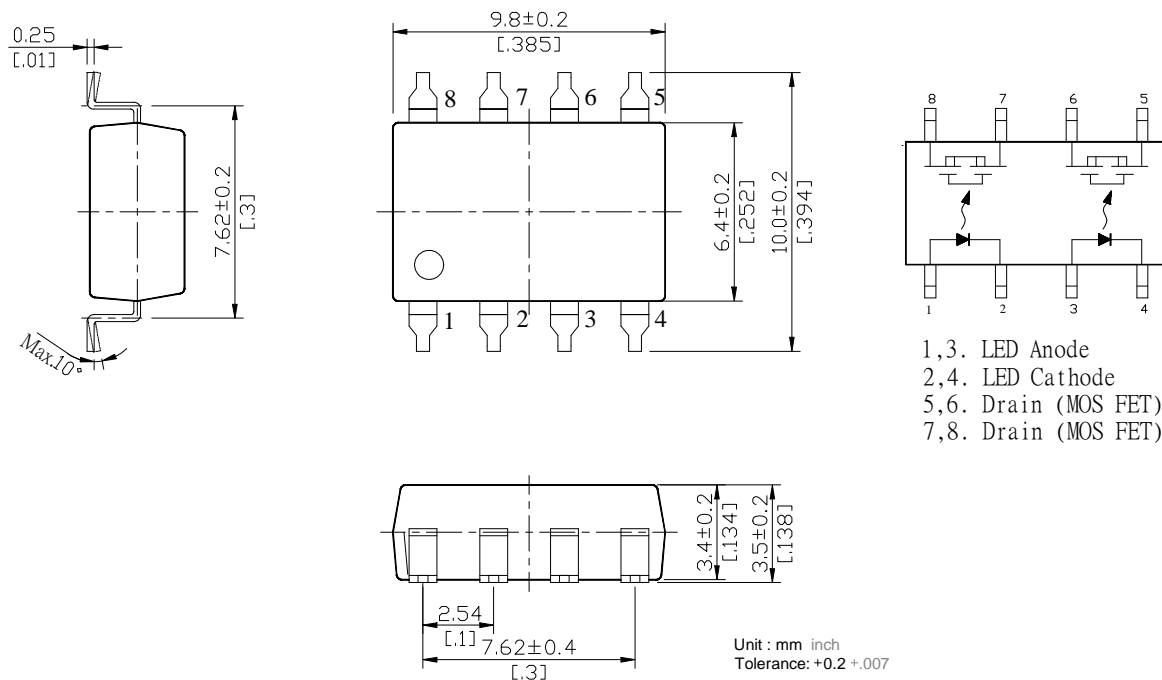

- 1,3. LED Anode
- 2,4. LED Cathode
- 5,6. Drain (MOS FET)
- 7,8. Drain (MOS FET)

Photo DMOS-FET Relay Specifications

Part Name: LT716

(Load voltage: 20V / Load current: 2.0A)

Absolute Maximum Ratings (Ambient Temperature: 25°C)

Item		Symbol	Value	Units	Note
Input	Continuous LED Current	I _F	50	mA	
	Peak LED Current	I _{FP}	1000	mA	f=100Hz, duty=1%
	LED Reverse Voltage	V _R	5	V	
	Input Power Dissipation	P _{In}	75	mW	
Output	Load Voltage	V _L	20	V(AC peak or DC)	
	Load Current	I _L	2.0	A	
	Peak Load Current	I _{Peak}	3.5	A	100ms(1 pulse)
	Output Power Dissipation	P _{out}	450	mW	
Total Power Dissipation		P _T	500	mW	
I/O Breakdown Voltage		V _{I/O}	3750	V _{rms}	RH=60%, 1min
I/O Breakdown Voltage(Suffix-V)		V _{I/O}	5000	V _{rms}	RH=60%, 1min
Operating Temperature		T _{Opr}	-40 to +85	-40 to +85	
Storage Temperature		T _{Stg}	-40 to +100	-40 to +100	
Pin Soldering Temperature		T _{Sol}	260	260	10 sec max.

Electrical Specifications (Ambient Temperature: 25°C)

Item		Symbol	MIN.	TYP.	MAX.	Units	Conditions
Input	LED Forward Voltage	V _F		1.2	1.5	V	I _F =10mA
	Operation LED Current	I _{F On}		0.5	5.0	mA	
	Recovery LED Current	I _{F Off}		0.35	0.5	mA	
	Recovery LED Voltage	V _{F Off}	0.5			V	
Output	On-Resistance	R _{On}		0.1	0.5	Ω	I _F =10mA, I _L =100mA, Time to flow is within 1 sec.
	Off-State Leakage Current	I _{Leak}			1	uA	V _L =Rating
	Output Capacitance	C _{Out}		150		pF	V _L =0, f=1MHz
Transmis sion	Turn-On Time	T _{On}		0.8	1.5	ms	I _F =10mA, I _L =100mA,
	Turn-Off Time	T _{Off}		0.02	0.5	ms	
Coupled	I/O Isolation Resistance	R _{I/O}	10 ¹⁰			Ω	DC500V
	I/O Capacitance	C _{I/O}		0.8	1.5	pF	f=1MHz

Reference Data

Load current Vs. Ambient temperature

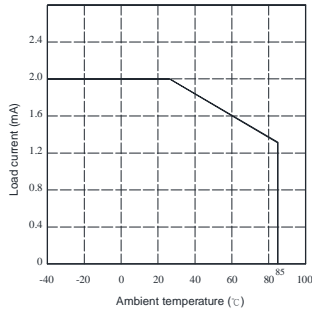

On resistance Vs. Ambient temperature

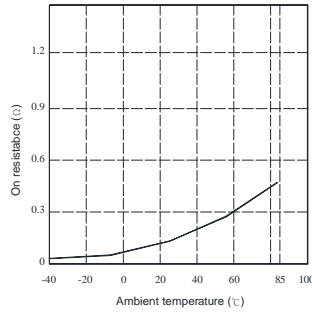

Turn on time Vs. Ambient temperature

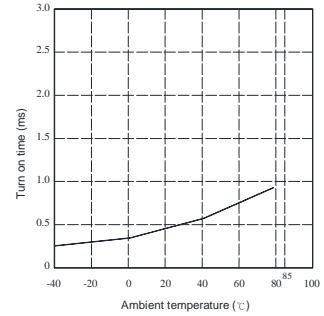

Turn off time Vs. Ambient temperature

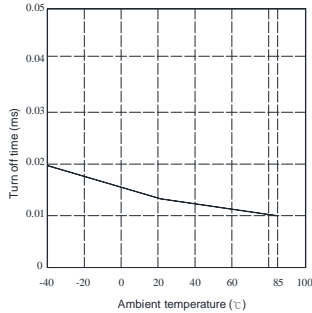

LED operate current Vs. Ambient temperature

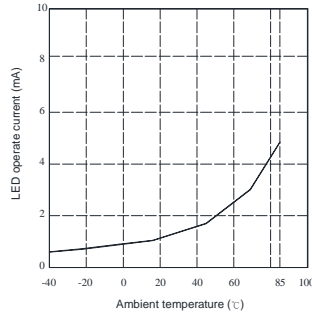

LED turn off current Vs. Ambient temperature

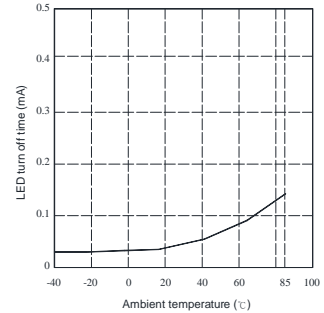

LED forward voltage Vs. Ambient temperature

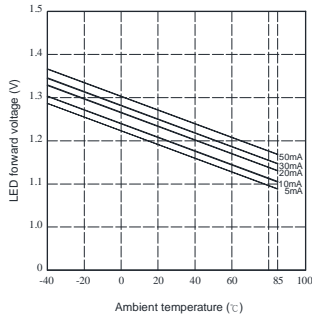

Voltage Vs. current characteristics of output at MOS portion

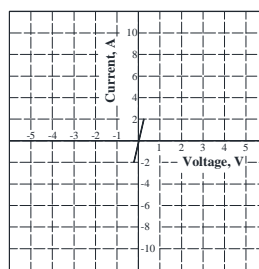

Off state leakage current Vs. Load voltage characteristics

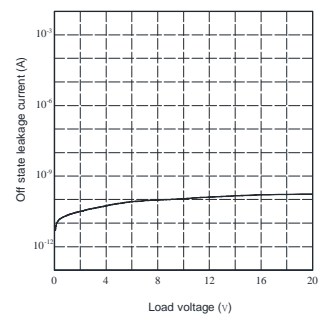

LED forward current Vs. turn on time characteristics

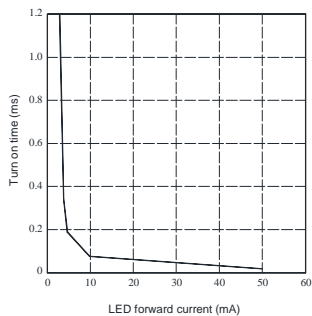

LED forward current Vs. turn off time characteristics

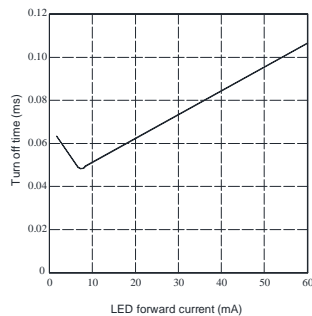

Applied voltage Vs. output capacitance characteristics

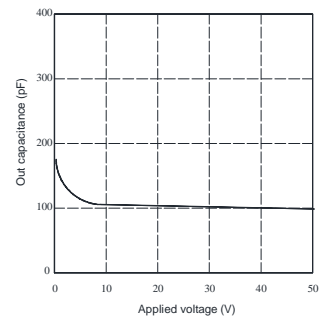

Taping Specifications for Surface Mount Devices

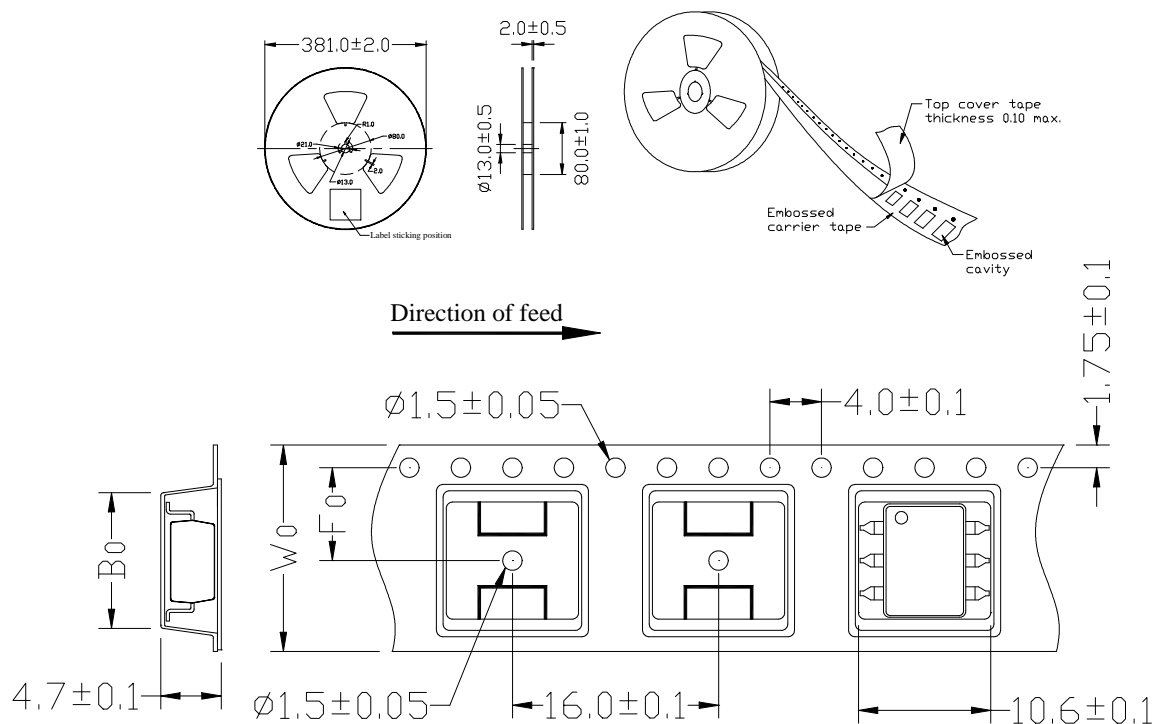

Unit: mm

TYPE	B0±0.1	F0±0.1	W0±0.1	15"REEL/PCS
8P	10.3	11.5	24	1000

Recommended Mounting Pad

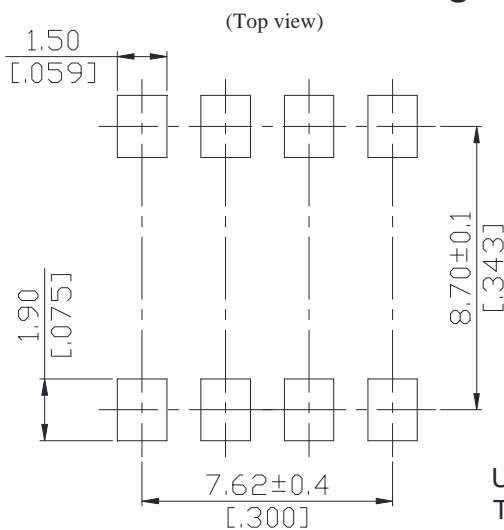

Unit : mm [inch]
Tolerance : ±0.1

Marking

(Each photo MOS Relay shall be marked with the following information)

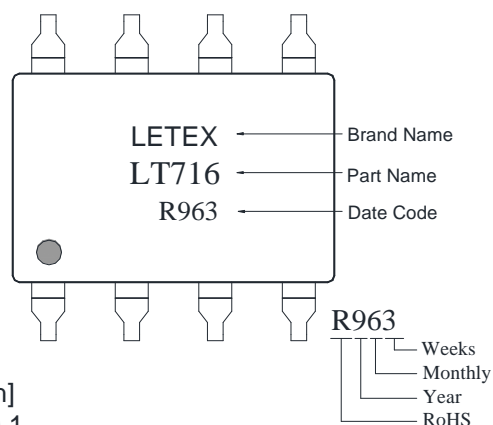

- Note: 1. There shall be leader of 230 mm minimum which may consist of carrier and or cover tape follower by a minimum of 160 mm of carrier tape sealed with cover tape.
 2. There shall be a minimum of 160 mm of empty component pockets sealed with cover tape.
 3. Devices are pockets in accordance with EIA standard EIA-481-A and specifications given above.