

Photo DMOS-FET Relay

Description

The **LT937HT** is a 1-Form A solid state relay in a 6 pin SMD package that employs optically coupled MOSFET technology to provide 3750V&5000V of input to output isolation. The optically coupled input is controlled by a highly efficient GaAlAs infrared LED and MOS FETs on the output side.

Features

- SMD package 6 Pin type in miniature design (8.8×6.4×3.4mm / .173×.169×.083inch)
- Low driver power requirements (TTL/CMOS Compatible)
- No moving parts
- High reliability
- Arc-Free with no snubbing circuits
- 3750 / 5000 Vrms Input/Output isolation
- Tape & Reel version available

Applications

- Telecommunications (PC, Electronic notepad)
- Measuring and Testing equipment
- Industrial control
- Security equipments
- High speed inspection machine

Outline Dimensions

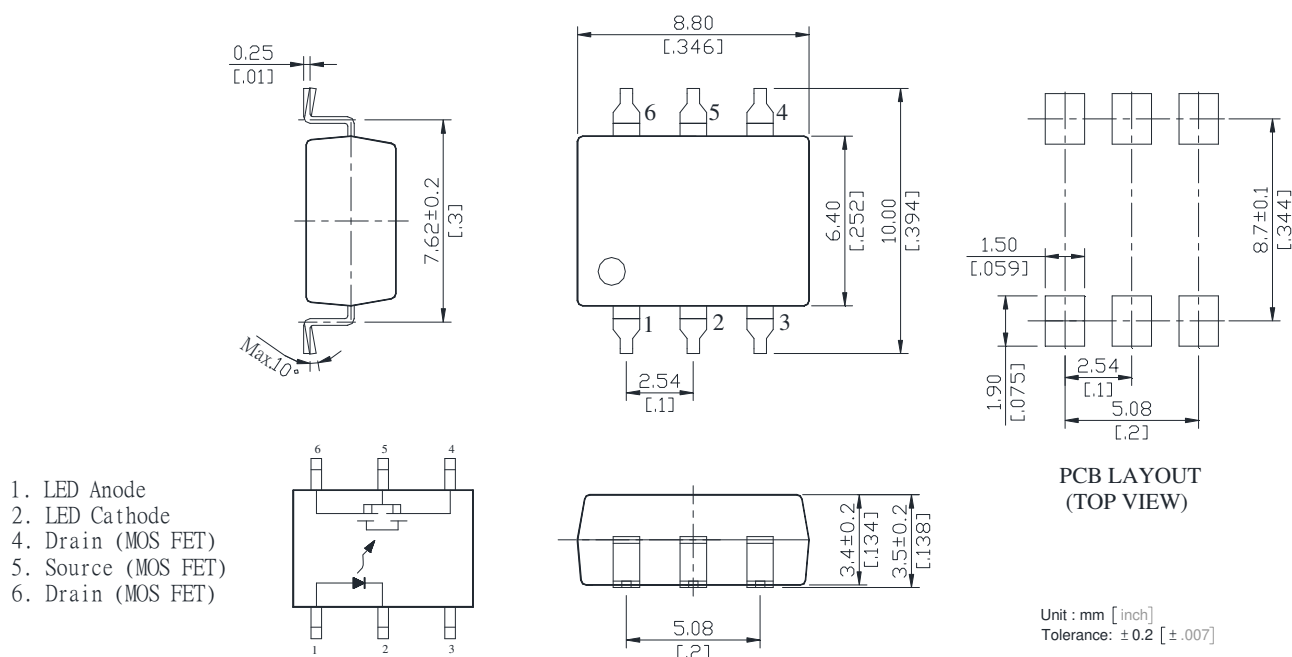

Photo DMOS-FET Relay Specifications

Part Name: LT937HT

(Load voltage:60V / Load current: 500mA)

Absolute Maximum Ratings (Ambient Temperature: 25°C)

Item	Symbol	Value	Units	Note	
Input	Continuous LED Current	I _F	50	mA	
	Peak LED Current	I _{FP}	1000	mA	f=100Hz, duty=1%
	LED Reverse Voltage	V _R	5	V	
	Input Power Dissipation	P _{In}	75	mW	
Output	Load Voltage	V _L	60	V(AC peak or DC)	
	Load Current	I _L	500	mA	
	Peak Load Current	I _{Peak}	3.0	A	300 μs(1 pulse)
	Output Power Dissipation	P _{out}	300	mW	
Total Power Dissipation		P _T	350	mW	
I/O Breakdown Voltage		V _{I/O}	3750	V _{rms}	RH=60%, 1min
I/O Breakdown Voltage(Suffix-V)		V _{I/O}	5000	V _{rms}	
Operating Temperature		T _{opr}	-40 to +125	°C	
Storage Temperature		T _{stg}	-40 to +135	°C	
Pin Soldering Temperature		T _{sol}	260	°C	10 sec max.

Electrical Specifications (Ambient Temperature: 25°C)

Item	Symbol	MIN.	TYP.	MAX.	Units	Conditions
Input	LED Forward Voltage	V _F	1.3	1.5	V	I _F =10mA
	Operation LED Current	I _{Fon}	5	10	mA	
	Recovery LED Current	I _{Foff}	0.35	0.5	mA	
	Recovery LED Voltage	V _{Foff}	0.7		V	
Output	On-Resistance	R _{on}	0.17	0.5	Ω	I _F =5mA, I _L =Rating, Time to flow is within 1 sec.
	Off-State Leakage Current	I _{Leak}		10	uA	V _L =Rating
	Output Capacitance	C _{out}	300		pF	V _L =0, f=1MHz
Transmis sion	Turn-On Time	T _{on}	1.2	5.0	ms	I _F =5mA, I _L = Rating
	Turn-Off Time	T _{off}	0.05	0.5	ms	
Coupled	I/O Isolation Resistance	R _{I/O}	10 ¹⁰		Ω	DC500V
	I/O Capacitance	C _{I/O}	1.0	1.5	pF	f=1MHz

Reference Data

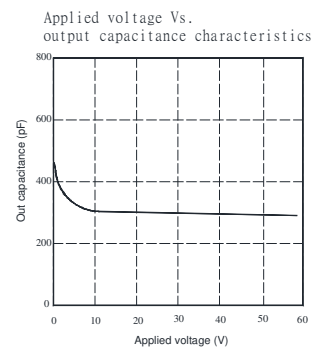
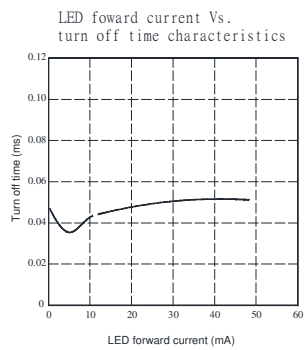
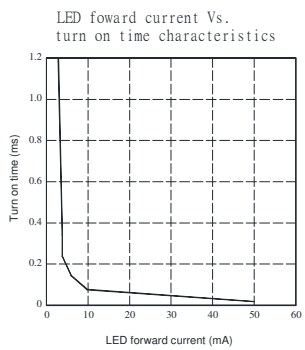
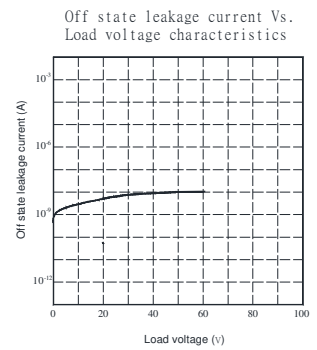
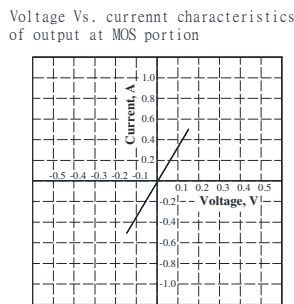
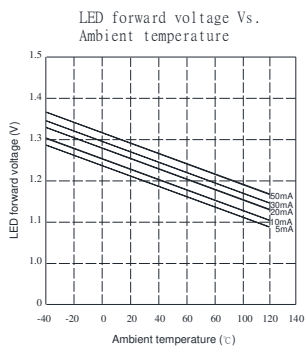
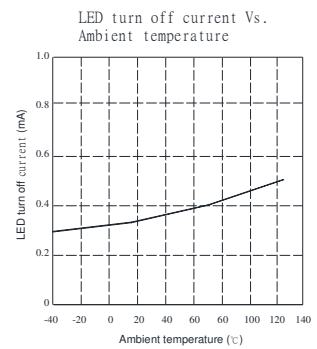
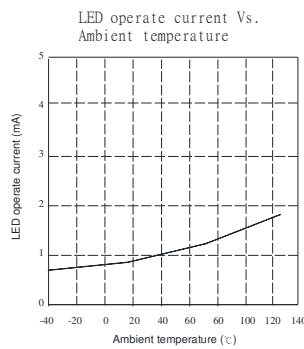
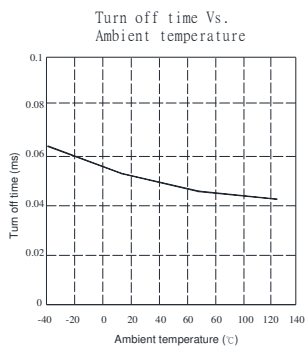
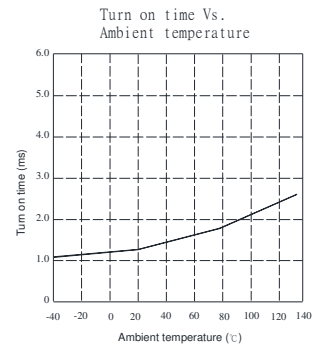
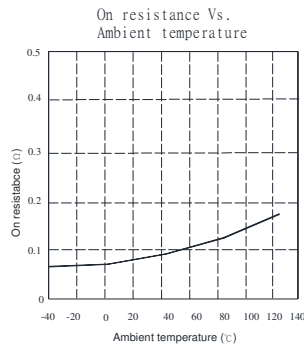
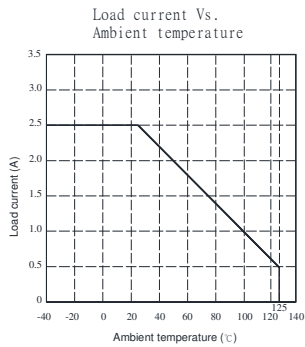

Taping Specifications for Surface Mount Devices

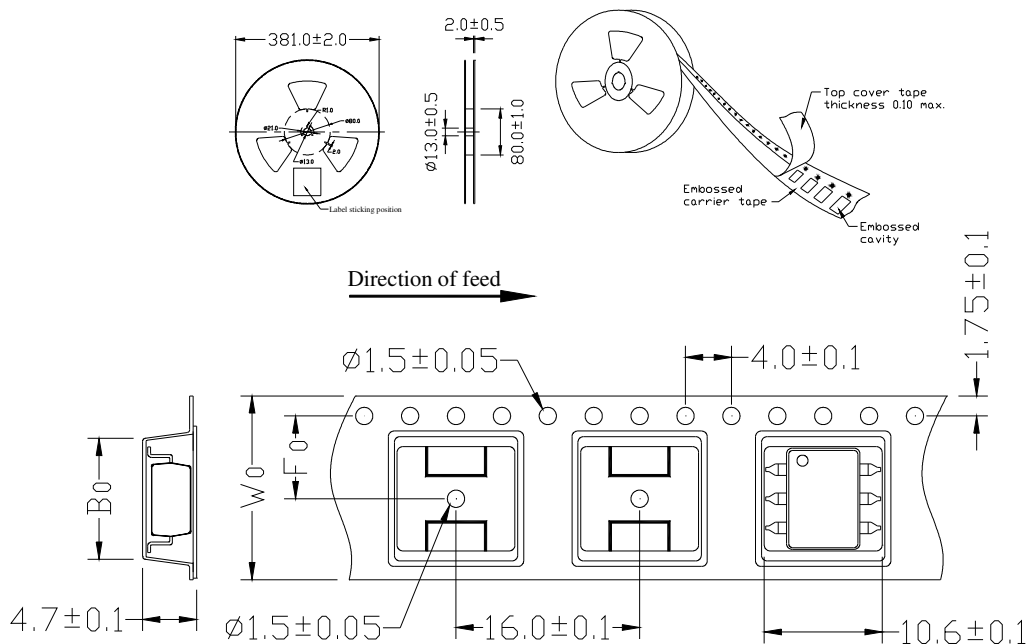

Unit: mm

TYPE	B0±0.1	F0±0.1	W0±0.1	15" REEL/PCS
6P	9.4	7.5	16	1000

Recommended Mounting Pad

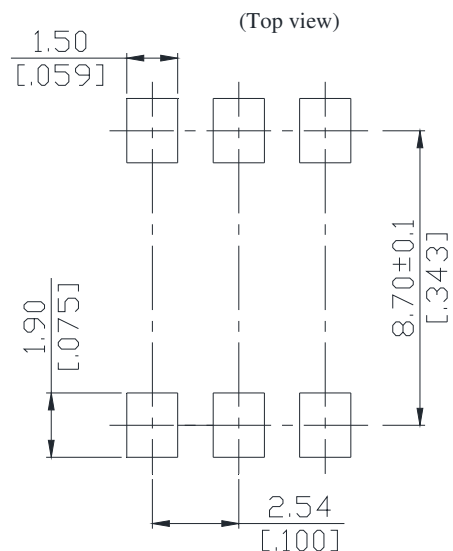

Unit : mm [inch]
Tolerance : ±0.1

Marking

(Each photo MOS Relay shall be marked with the following information)

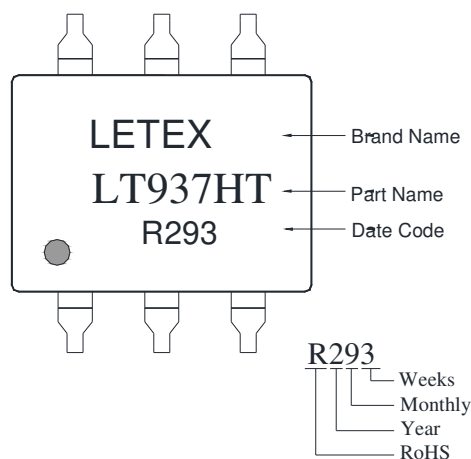

- Note:
1. There shall be leader of 230 mm minimum which may consist of carrier and or cover tape follower by a minimum of 160 mm of carrier tape sealed with cover tape.
 2. There shall be a minimum of 160 mm of empty component pockets sealed with cover tape.
 3. Devices are pockets in accordance with EIA standard EIA-481-A and specifications given above.