

Photo DMOS-FET Relay

Description

The **LU310** is a miniature 2-Form B solid state relay in a 8 pin SOP package that employs optically coupled MOSFET technology to provide 1500V of input to output isolation. The optically coupled input is controlled by a highly efficient GaAlAs infrared LED and MOS FETs on the output side.

Features

- SOP package 8 Pin type in miniature design (9.4×4.4×2.0mm / .370×.173×.079inch)
- Low driver power requirements (TTL/CMOS Compatible)
- Contact form: Normally-On (2b)
- Load voltage: 400V max.
- On-Resistance: 50Ω max.
- 1500Vrms Input/Output isolation
- Tape & Reel version available

Applications

- Telecommunications (PC, Electronic notepad)
- Measuring and Testing equipment
- Industrial control
- Security equipments
- High speed inspection machine

Outline Dimensions

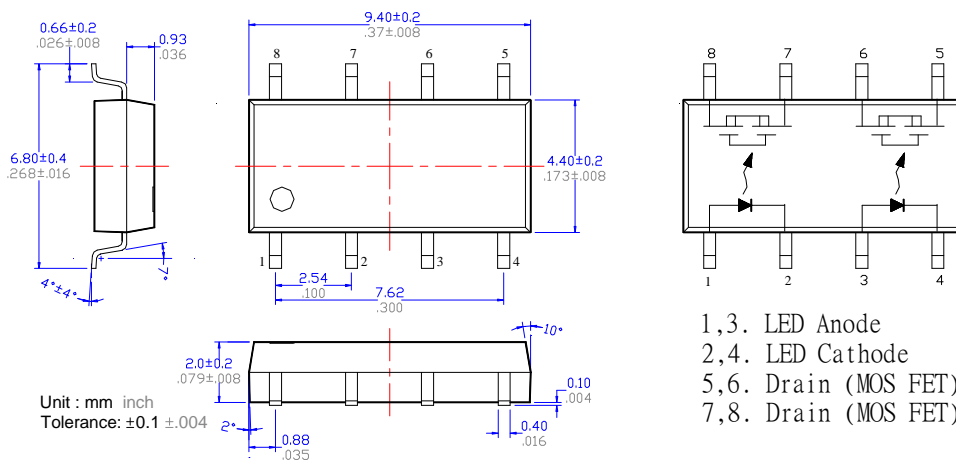

Photo DMOS-FET Relay Specifications

Part Name: LU310

(Load voltage: 400V / Load current: 120mA)

Absolute Maximum Ratings (Ambient Temperature: 25°C)

Item	Symbol	Value	Units	Note	
Input	Continuous LED Current	IF	50	mA	
	Peak LED Current	IFP	1000	mA	f=100Hz, duty=1%
	LED Reverse Voltage	VR	5	V	
	Input Power Dissipation	PIn	75	mW	
Output	Load Voltage	VL	400	V(AC peak or DC)	
	Load Current	IL	120	mA	
	Peak Load Current	IPeak	0.3	A	1ms(1 pulse)
	Output Power Dissipation	Pout	500	mW	
Total Power Dissipation	PT	550	mW		
I/O Breakdown Voltage	VIO	1500	Vrms	RH=60%, 1min	
Operating Temperature	Topr	-40 to +85	°C		
Storage Temperature	Tstg	-40 to +100	°C		
Pin Soldering Temperature	Tsol	260	°C	10 sec max.	

Electrical Specifications (Ambient Temperature: 25°C)

Item	Symbol	MIN.	TYP.	MAX.	Units	Conditions
Input	LED Forward Voltage	V _F	1.2	1.4	V	IF=10mA
	Operation LED Current	IFon	0.5	3.0	mA	
	Recovery LED Current	IFoff	0.35	0.5	mA	
	Recovery LED Voltage	V _{Foff}	0.5		V	
Output	On-Resistance	R _{on}	20	50	Ω	IF=0mA, IL=100mA, Time to flow is within 1 sec.
	Off-State Leakage Current	I _{Leak}		10	uA	IF=5mA, VL=400V
	Output Capacitance	C _{out}		165	pF	IF=5mA, VL=0, f=1MHz
Transmission	Turn-Off Time	T _{off}	0.5	3.0	ms	IF=5mA, IL=100mA
	Turn-On Time	T _{on}	0.02	1.0	ms	
Coupled	I/O Isolation Resistance	R _{I/O}	10 ¹⁰		Ω	DC500V
	I/O Capacitance	C _{I/O}		0.8	pF	f=1MHz

Reference Data

Load current Vs. Ambient temperature

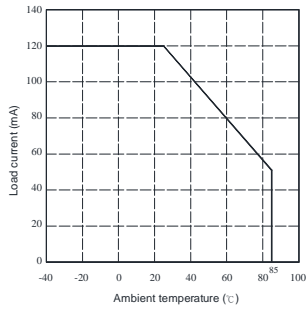

On resistance Vs. Ambient temperature

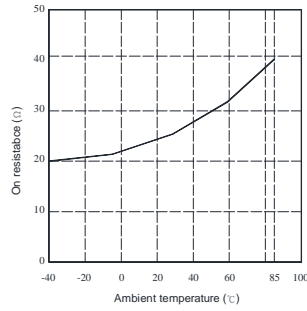

Operate (OFF) time Vs. Ambient temperature

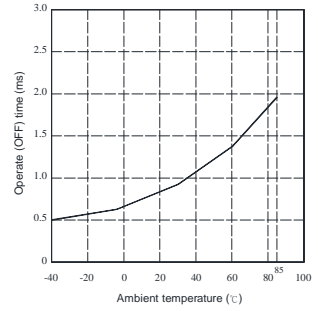

Reverse (ON) time Vs. Ambient temperature

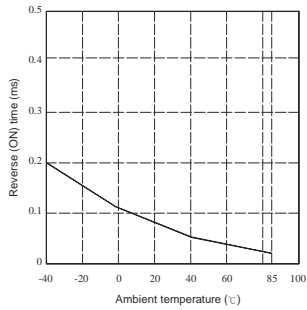

LED operate (OFF) current Vs. Ambient temperature

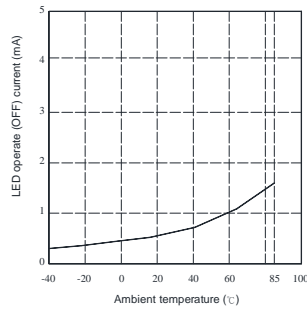

LED turn off current Vs. Ambient temperature

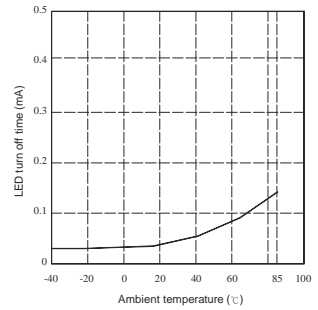

LED forward voltage Vs. Ambient temperature

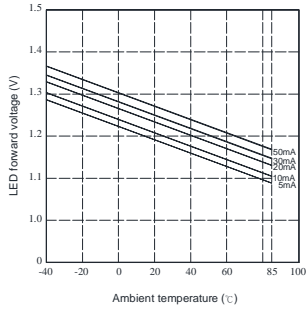

Voltage Vs. current characteristics of output at MOS portion

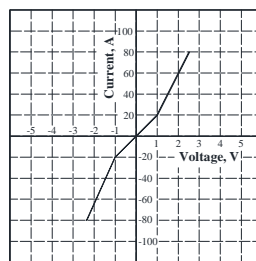

Off state leakage current Vs. Load voltage characteristics

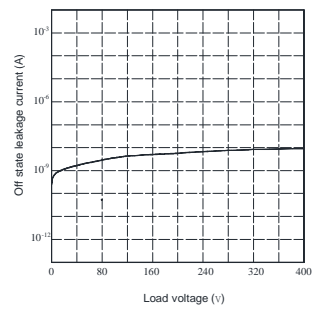

LED forward current Vs. Reverse (ON) time characteristics

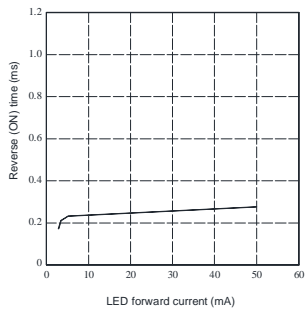

LED forward current Vs. Operate (OFF) time characteristics

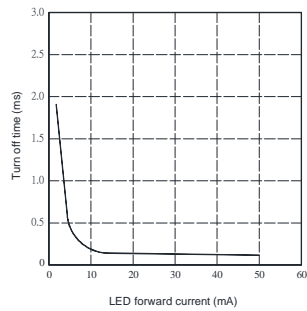

Applied voltage Vs. output capacitance characteristics

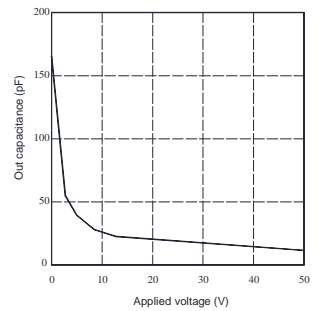

Taping Specifications for Surface Mount Devices

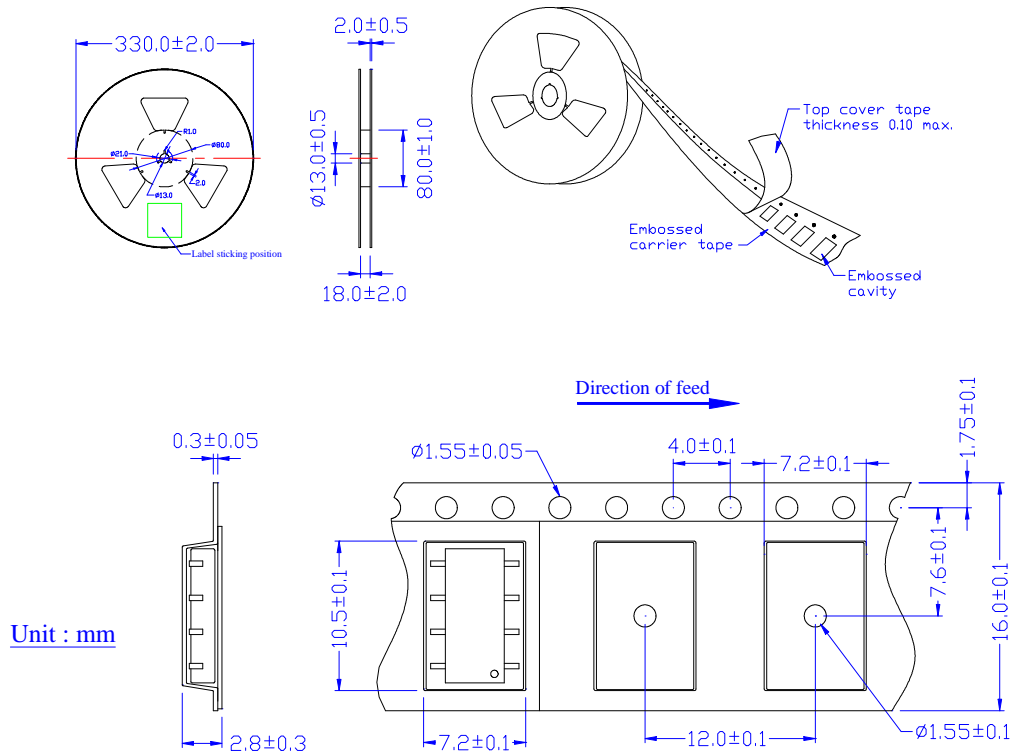

Recommended Mounting Pad

(Top view)

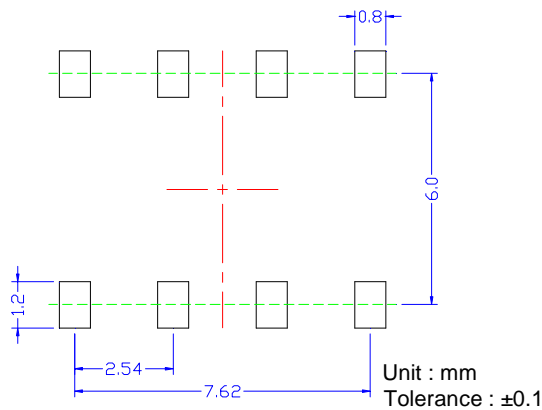

Marking

(Each photo MOS Relay shall be marked with the following information)

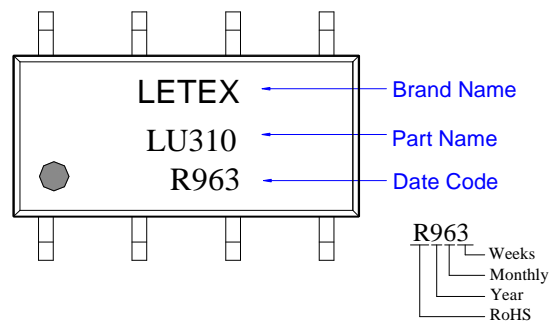

- Note:
1. There shall be leader of 230 mm minimum which may consist of carrier and or cover tape follower by a minimum of 160 mm of carrier tape sealed with cover tape.
 2. There shall be a minimum of 160 mm of empty component pockets sealed with cover tape.
 3. Devices are pockets in accordance with EIA standard EIA-481-A and specifications given above.
 4. Packaging: 1,000pcs per reel, 2 reel per box, 5 boxes per carton.