

1

2

3

4

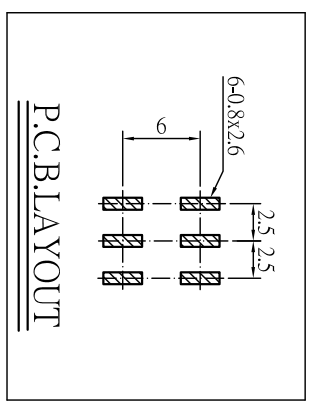
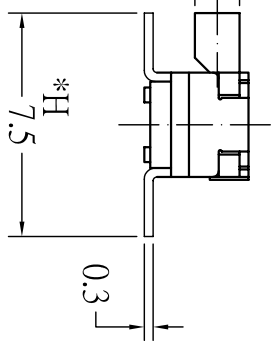
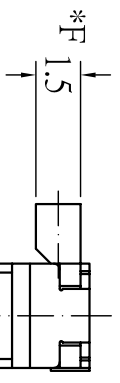
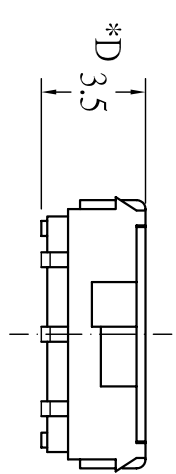
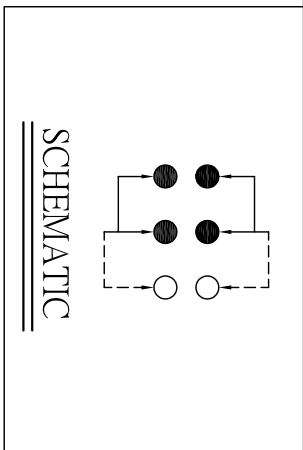
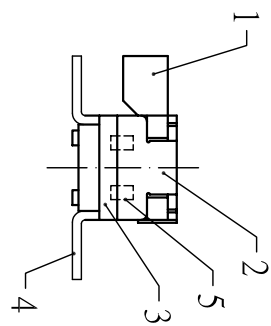
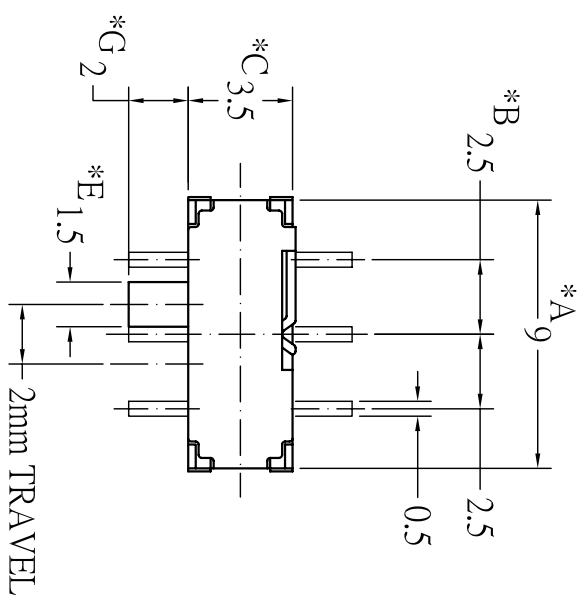
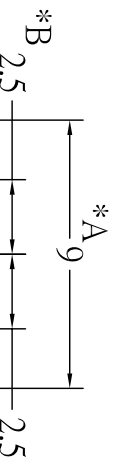

* CRITICAL DIMENSION

A

B

C

D

CHI FUNG ELECTRONICS CO.,LTD.

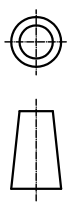

SERIES : MINI SLIDE SWITCH	DRAWING NO.: CF-ENL-MSH4015
PART NAME: MSH-22N01S	GENERAL TOLERANCE
UNIT : MM	WTTIN 0.XXmm±0.15mm
SCALE : 4:1	OVER 0.Xmm±0.25mm
REV : A/0	APPD.

NO.	PART NAME	MATERIAL	QTY	FINISHING
1	STEM	PA46	1	NATURAL
2	COVER	SUS	1	NATURAL
3	CASE	PA46	1	BLACK
4	TERMINAL	BRASS	6	Ag COATING
5	CONTACT	C5210R-EH	2	Ag CLAD
6				
7				

D

B

C

A

1

2

3

4