

1

2

3

4

A

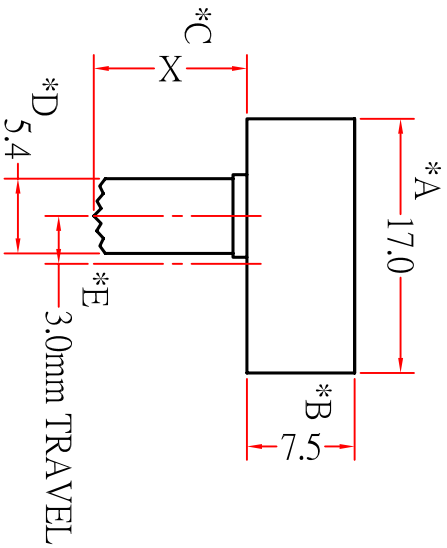

A

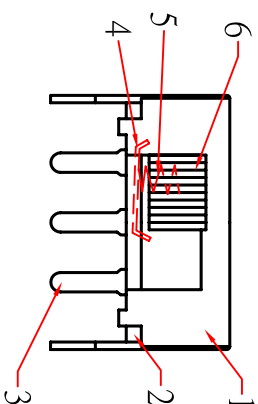
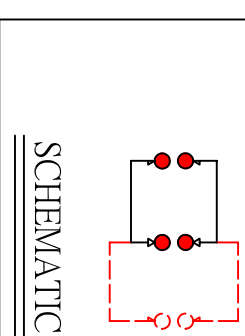

B

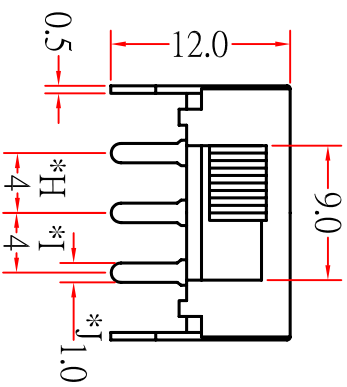

C

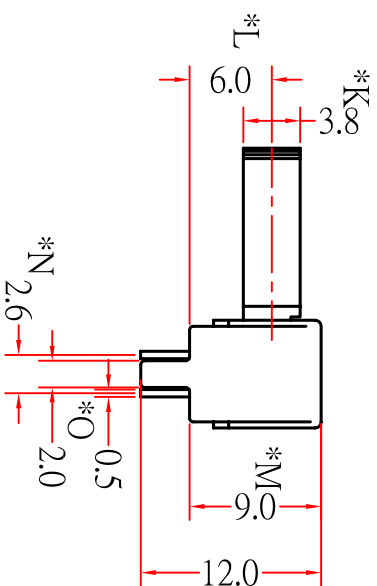

C

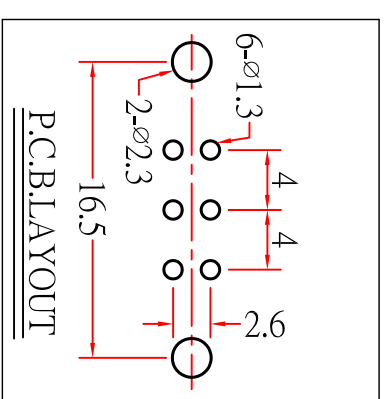

* CRITICAL DIMENSION

D

CHI FUNG ELECTRONICS CO.,LTD.

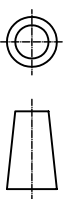

SERIES : SLIDE SWITCH

DRAWING NO.: CF-ENL-SSH4052

PART NAME: SSH-22F02-GX

GENERAL TOLERANCE

UNIT : MM

CHK'D

WITHIN 0.XXmm±0.15mm

SCALE : 2 : 1

APPD.

OVER 0.Xmm±0.25mm

REV : A/0

NO.

PART NAME

NO.	PART NAME	MATERIAL	QTY	FINISHING
1	FRAME	SPN STRIP	1	NI COATING
2	BASE	PHENOLIC RESIN	1	BLACK
3	TERMINAL	BRASS	6	AG COATING
4	CONTACT	BRASS	2	AG COATING
5	SPRING	STEEL WIRE	2	NATURAL
6	KNOB	POM	1	BLACK
7				

D

1

2

3

4