

1

2

3

4

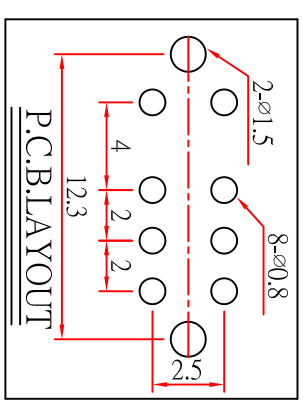
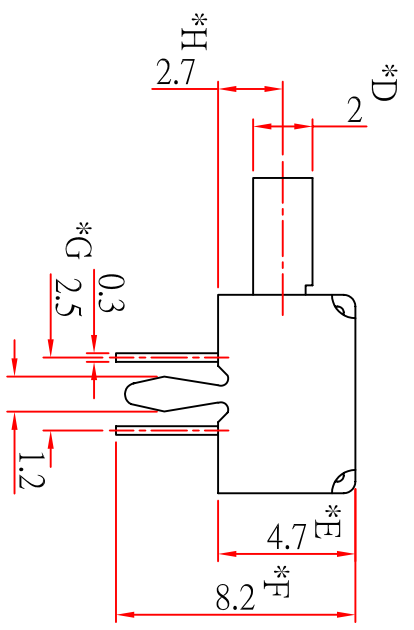
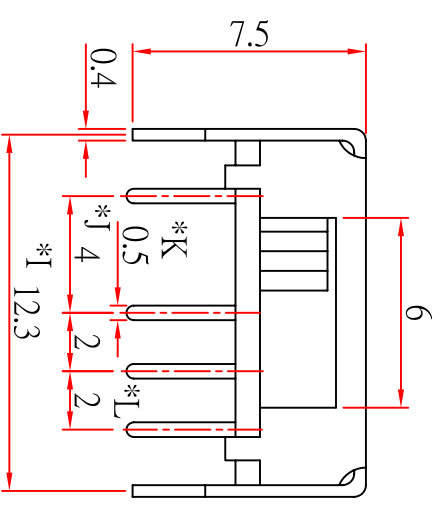
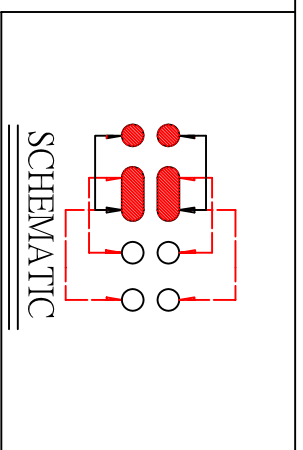
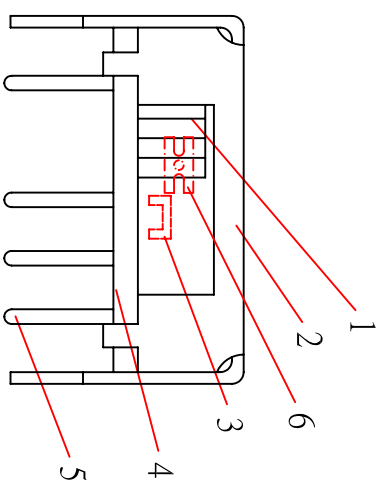
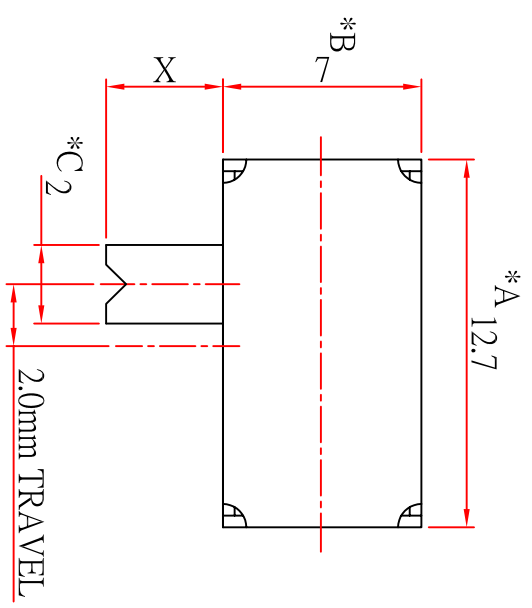

* CRITICAL DIMENSION

CHI FUNG ELECTRONICS CO.,LTD.

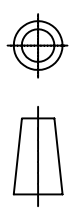

SERIES : SLIDE SWITCH	
PART NAME: SSH-23D03-VGX	
UNIT : M/M	DW/N.
SCALE : 4:1	CHK/D
REV : A/0	APPD.

DRAWING NO: CE-ENL-SSH4034	
GENERAL TOLERANCE	
WITHIN 0.XXmm±0.15mm	
OVER 0.Xmm±0.25mm	

7				
6	SPRING PLATE	SUS	1	NATURAL
5	TERMINAL	BRASS	8	Ag COATING
4	BASE	PHENOLIC RESIN	1	YELLOW
3	CONTACT	PBS	2	Ag COATING
2	FRAME	SPN STRIP	1	Ni COATING
1	KNOB	POM	1	BLACK
NO.	PART NAME	MATERIAL	QTY	FINISHING

D

C

B

A

1

2

3

4