

1

2

3

4

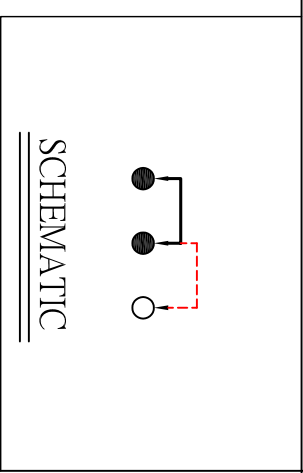
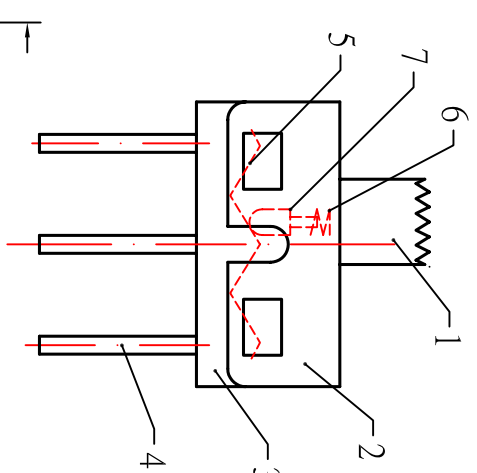
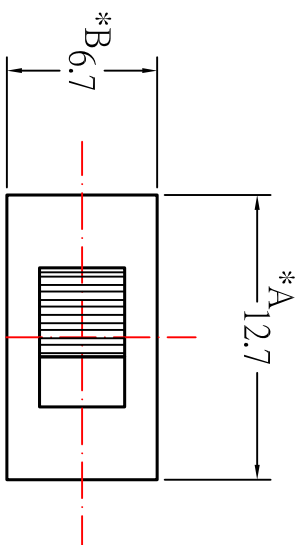

A

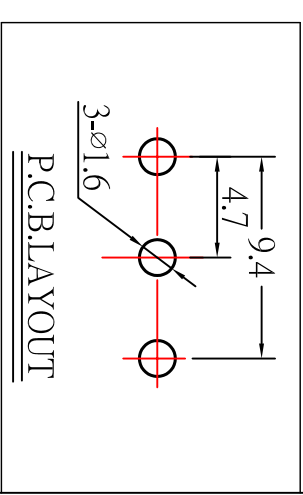
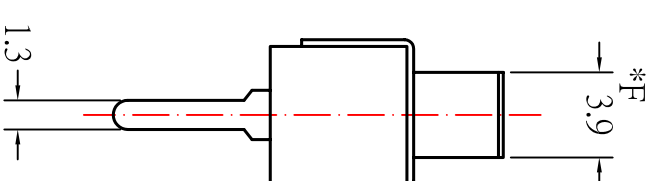
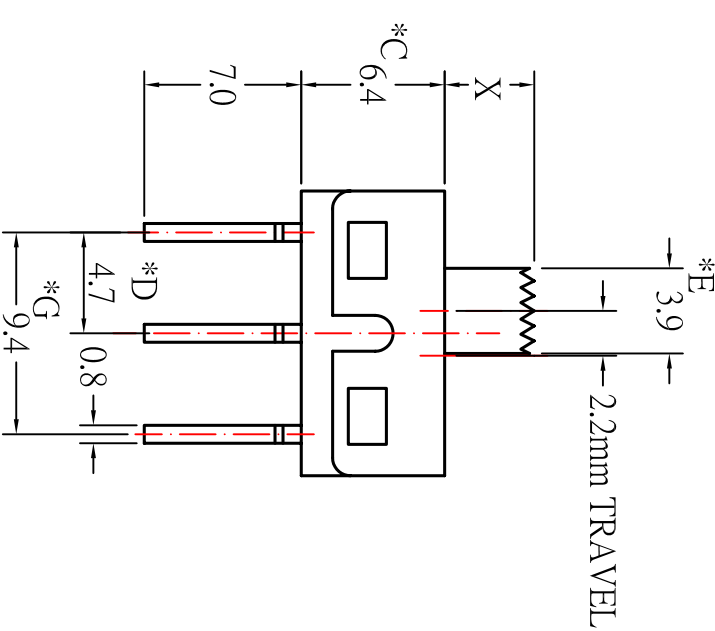

C

* CRITICAL DIMENSION

D

CHI FUNG ELECTRONICS CO.,LTD.

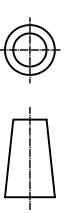

SERIES : SLIDE SWITCH		DRAWING NO. : CF-ENJ-SSV4052	
PART NAME:SSV-12D10-GX		GENERAL TOLERANCE	
UNIT : MM	DWN.	WITHIN 0.XXmm±0.15mm	
SCALE : 3:1	CHK'D	OVER 0.Xmm±0.25mm	
REV : A/0	APPD.		

NO.	PART NAME	MATERIAL	QTY	FINISHING
7	BAR	PA66	1	BLACK
6	SPRING	STEEL WIRE	1	TEMPER
5	CONTACT	COPPER	1	Ag CLAD
4	TERMINAL	BRASS	3	Ag COATING
3	CASE	PA66	1	BLACK
2	COVER	STAINLESS STEEL	1	NATURAL
1	KNOB	POM	1	BLACK

D

B

B

1

2

3

4