

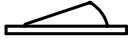

- \* Product Name: Rocker Switch;
- \* Model No: YSR-11 (C)
- \* Voltage Resistance: 2000VAC, 1MIN;
- \* Operating Temperature: T85
- \* Electrical Life: more than 10,000cycles
- \* Contact Rating: UL CUL: 3/6A 250/125VAC, 5/10A 250/125VAC  
6.5/13A 250/125VAC, 10/15A 250/125VAC

KNOB COLOR	BLACK; RED; GREEN; ORANGE; BLUE; ...		
BASE COLOR	GRAY; BLACK; WHITE; ...		
KNOB SHAPE	TYPE A: 		
Illuminate	YSR-11-11 (C) /N 1P1T 3P	Unilluminate	YSR-11-11 (C) 1P1T 2P

### Wiring Diagram

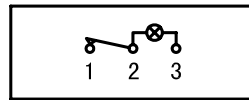

YSR-11-11 (C) /N  
On-Off (Illuminate)

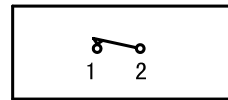

YSR-11-11 (C)  
On-Off (Illuminate)

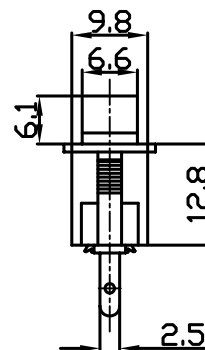
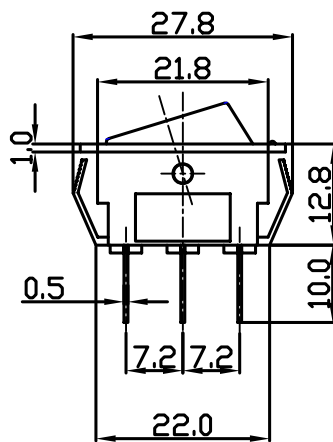

### Panel Installation Size

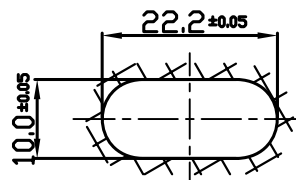
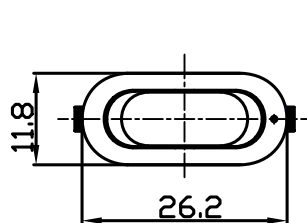

Panel Installation  
Thickness 1 ~ 4mm

Тел.: (495) 795-0805  
Факс: (495) 545-0869  
Эл. почта: info@rct.ru  
Веб: www.rct.ru

**РАДИОТЕХ**