

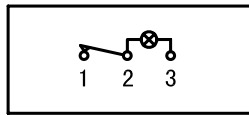

- * Product Name: Rocker Switch;
- * Model No: YSR-14 (B)
- * Voltage Resistance: 2000VAC, 1MIN;
- * Operating Temperature: T85
- * Electrical Life: more than 10,000cycles
- * Contact Rating: UL CUL: 3/6A 250/125VAC, 5/10A 250/125VAC

KNOB COLOR	BLACK; RED; GREEN; ORANGE; BLUE; ...		
BASE COLOR	GRAY; BLACK; WHITE; ...		
KNOB SHAPE	TYPE C: 	Unilluminate	YSR-14-12 (B) 1P2T 3P
Illuminate	YSR-14-11 (B) /N 1P1T 3P		YSR-14-11 (B) 1P1T 2P

Wiring Diagram



YSR-14-11 (B) /N
On-Off (Illuminate)

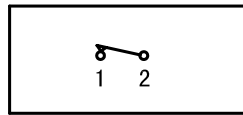

YSR-14-11 (B)
On-Off (Unilluminate)

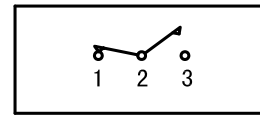

YSR-14-12 (B)
On-On (Unilluminate)

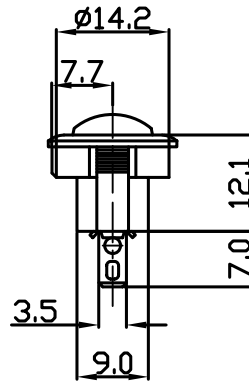
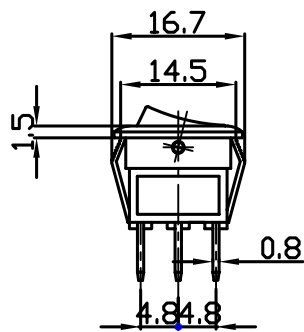

Panel Installation Size

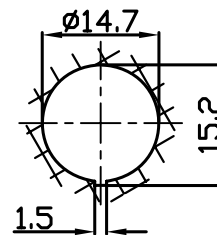
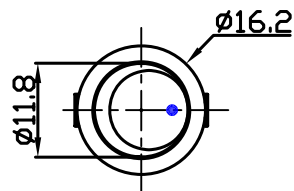

Panel Installation
Thickness 1 ~ 4mm