

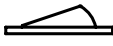

- * Product Name: Rocker Switch;
- * Model No: YSR-15(8)
- * Voltage Resistance: 2000VAC, 1MIN;
- * Operating Temperature: T85
- * Electrical Life: more than 10,000cycles
- * Contact Rating: UL CUL: 10/15A 250/125VAC, 16/20A 250/125VAC, 1/2HP 125VAC
VDE: 16A 250V ~



KNOB COLOR	BLACK; RED; GREEN; ORANGE; BLUE; ...		
BASE COLOR	GRAY; BLACK; WHITE; ...		
KNOB SHAPE	TYPE A: 	Unilluminate	YSR-15-11 (8) 1P1T 2P
Illuminate	YSR-15-11 (8) /N 1P1T 3P		YSR-15-12 (8) 1P2T 3P
			YSR-15-13 (8) 1P2T 3P

Wiring Diagram

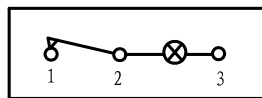

YSR-15-11 (8) /N
On-Off (Illuminate)

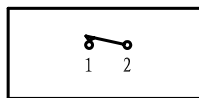

YSR-15-11 (8)
On-Off (Unilluminate)

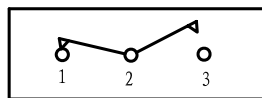

YSR-15-12 (8)
On-On (Unilluminate)

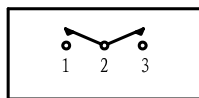

YSR-15-13 (8)
On-Off-On (Unilluminate)

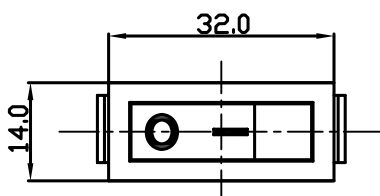
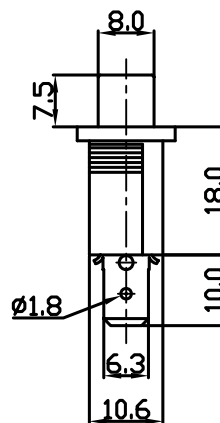
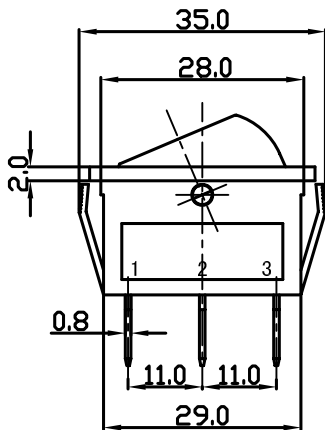

Panel Installation Size

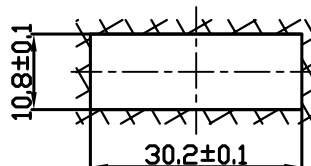

Panel Installation
Thickness 1 ~ 4mm