

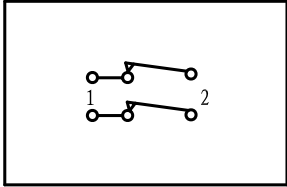

<ul style="list-style-type: none"> * Product Name: Rocker Switch; * Model No: YSR-24 * Voltage Resistance: 2000VAC, 1MIN; * Operating Temperature: T85 * Electrical Life: more than 10,000cycles * Contact Rating: UL CUL: 6/10A 250/125VAC, 3/6A 250/125VAC 	
KNOB COLOR	BLACK; RED; GREEN; ORANGE; BLUE; ...
BASE COLOR	GRAY; BLACK; WHITE; ...
KNOB SHAPE	TYPE C: 
Illuminate	YSR-24-21 2P1T 4P, YSR-24-11 1P1T 2P



Wiring Diagram



YSR-24-21
On-Off (Unilluminate)

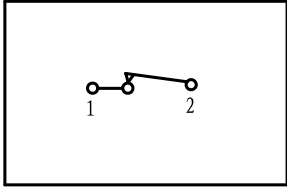

YSR-24-11
On-Off (Unilluminate)

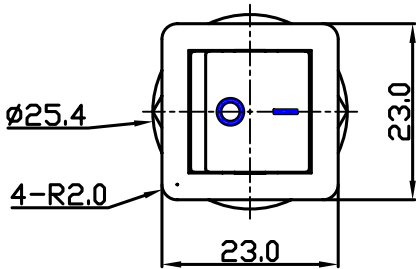
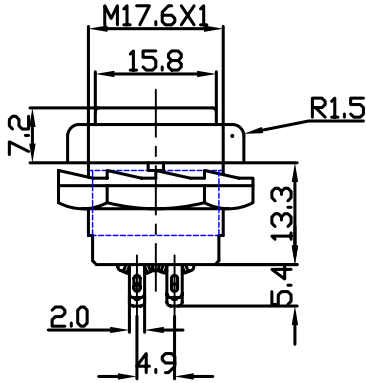
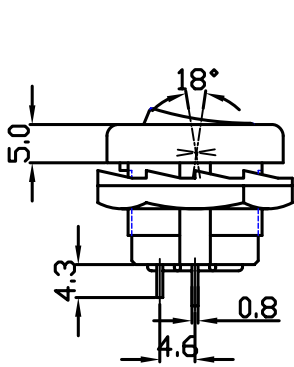

Panel Installation Size

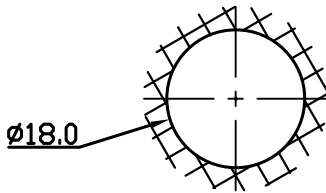

Panel Installation
Thickness 1 ~ 4mm