





- * Product Name: Rocker Switch;
- * Model No: YSR-9-21 (A)
- * Voltage Resistance: 2000VAC, 1MIN;
- * Operating Temperature: T85 T105
- * Electrical Life: more than 10,000cycles
- * Contact Rating: UL、CUL: 10/15A 250/125VAC
16/20A 250/125VAC
VDE: 10 (4) A 250V ~
16 (6) A 250V ~



China, Korean Patent

KNOB COLOR	BLACK; RED; GREEN; ORANGE; BLUE; ...		
BASE COLOR	GRAY; BLACK; WHITE; ...		
KNOB SHAPE	TYPE C:  TYPE D: 		
Illuminate	YSR-9-21 (A) /N 2P1T 4P	Unilluminate	YSR-9-21 (A) 2P1T 4P

Wiring Diagram

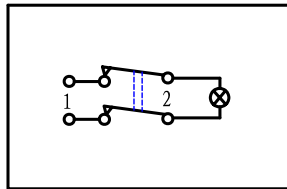

YSR-9-21 (A) /N
On-Off (Illuminate)

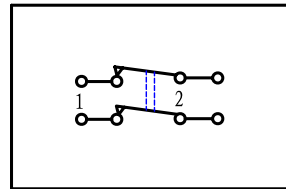

YSR-9-21 (A)
On-Off (Unilluminate)

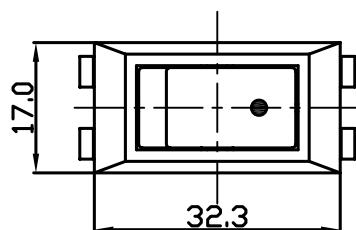
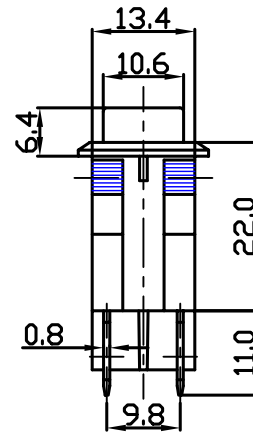
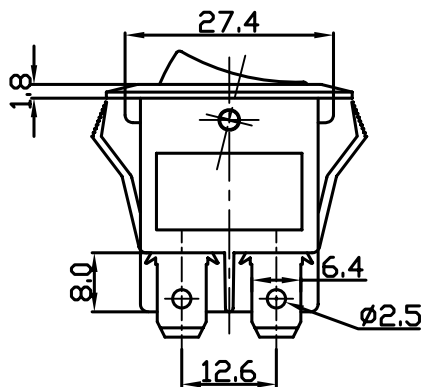

Panel Installation Size

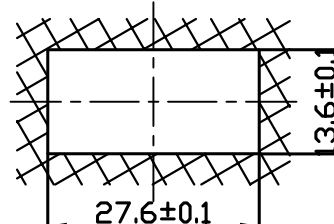

Panel Installation
Thickness 1 ~ 4mm