







<ul style="list-style-type: none"> * Product Name: Rocker Switch; * Model No: YSR-9-21 (B) * Voltage Resistance: 2000VAC, 1MIN; * Operating Temperature: T85 T105 * Electrical Life: more than 10,000cycles * Contact Rating: UL、CUL: 10/15A 250/125VAC 16/20A 250/125VAC VDE: 10 (4) A 250V ~ 16 (6) A 250V ~ 				 	China, Korean Patent	
KNOB COLOR	BLACK; RED; GREEN; ORANGE; BLUE; ...					
BASE COLOR	GRAY; BLACK; WHITE; ...					
KNOB SHAPE	TYPE C:  TYPE D: 					
Illuminate	YSR-9-21 (B) /N 2P1T 4P	Unilluminate	YSR-9-21 (B) 2P1T 4P			

Wiring Diagram

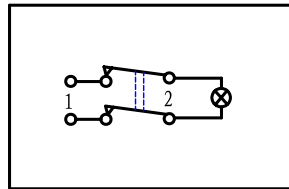

YSR-9-21 (B) /N
On-Off (Illuminate)

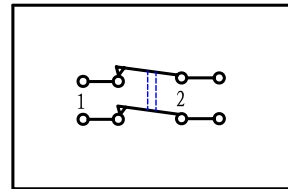

YSR-9-21 (B)
On-Off (Unilluminate)

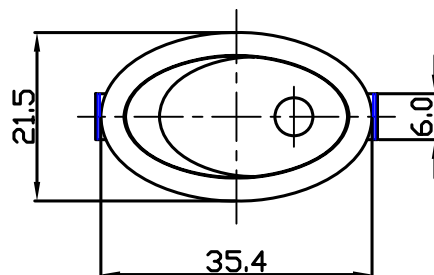
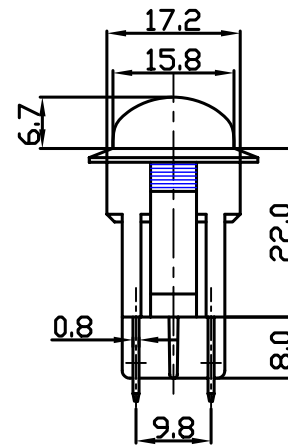
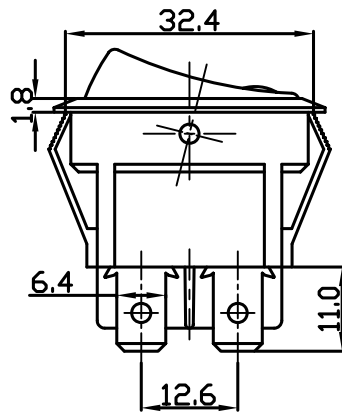

Panel Installation Size

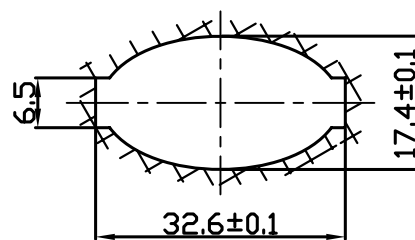

Panel Installation
Thickness 1 ~ 4mm

Тел.: (495) 795-0805
Факс: (495) 545-0869
Эл. почта: info@rct.ru
Веб: www.rct.ru

РАДИОТЕХ