

REV	CONTENT	CHK	DATE
V0.0	CONTENT	MYZ	21.07.02

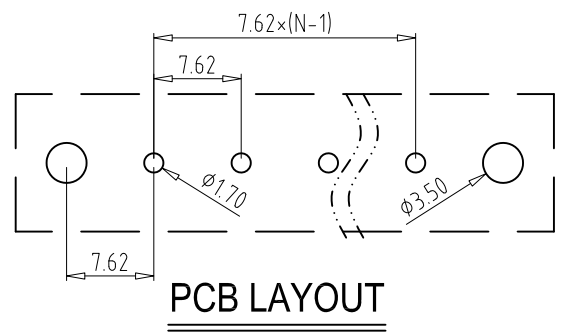

Electrical :

- | | | |
|---|---------------|--------------------|
| | UL | IEC |
| 1. Rated Voltage : | 300V | 250V |
| 2. Rated Current : | 15A | 24A |
| 3. Torque Value : | M3, 4.43Lb.in | M3 , 0.5N.m |
| 4. Wire Range: | 22-14AWG | 2.5mm ² |
| 5. Stripping Length : | 7-8mm | |
| 6. Withstanding Voltage : | AC1600V/1Min. | |
| 7. Operating Temperature : | -40°C~+110°C | |
| 8. RoHS Compliance | | |
| 9. Safty Approval : | cULus CE | |
| 10. "★" is the key quality control point. | | |

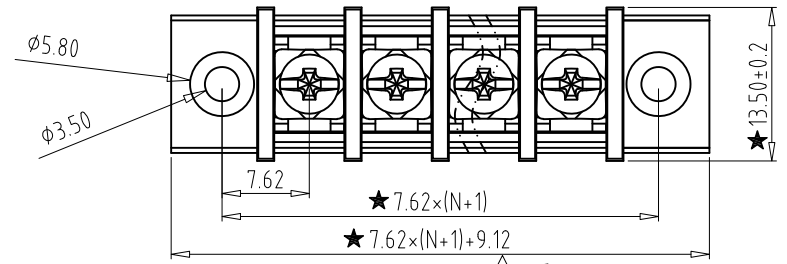
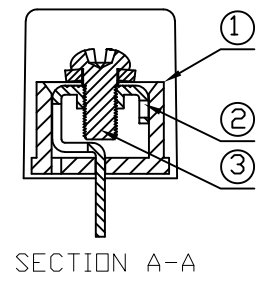

GT25C-A - XXP - X X - 00

① ② ③ ④ ⑤

- ① Series No.
- ② Poles
- ③ 1 Single Pitch
2 Double Pitch
- ④ Color: 1 Grey
2 Blue
3 Black
4 Green
5 Orange
6 Red
7 Transparent
8 Yellow
9 White
- ⑤ Customer Request : 00--Standard

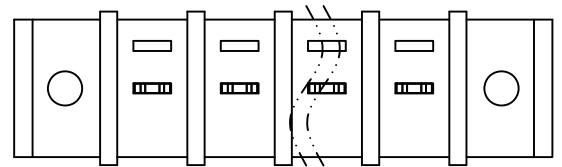
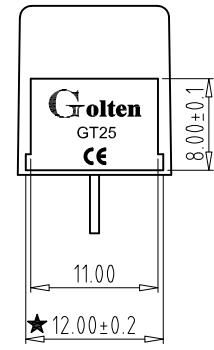
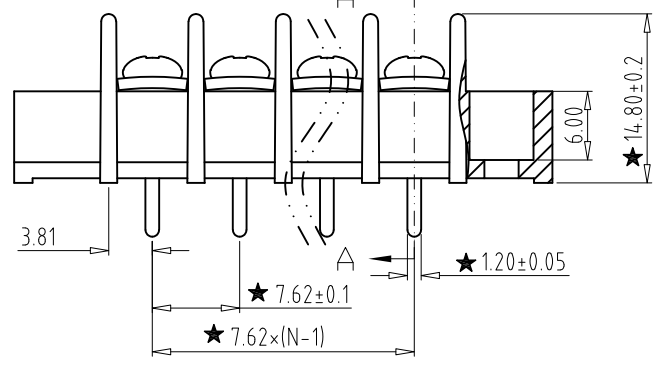
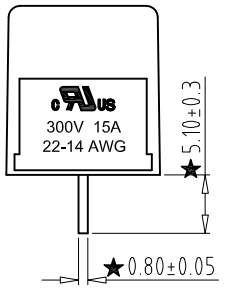

Total Pitch Tolerances in mm										Nominal dimension range in mm										⊥	≡	-	//		
over 0	over 30	over 53	over 70	over 90	over 115	over 150	over 250	over 350	over 500	over 0	over 30	over 53	over 70	over 90	over 115	over 150	over 200	over 250	over 320	0	over 10	all	over 0	over 100	over 150
±0.18	±0.20	±0.25	±0.3	±0.35	±0.4	±0.60	±0.70	±0.85	±0.20	±0.25	±0.30	±0.35	±0.4	±0.55	±0.70	±0.80	±0.90	0.2	0.3	0.3	0.2	0.3	0.5		

1	Housing	XXXXXX	1	PA66	UL94V-0
2	Contact	XXXXXX	N	Brass	Tin Plated
3	Screws	XXXXXX	N	Steel	Ni Plated
ITEM	NAME OF PART	NO. OF PART	Q'TY	MATERIAL	NOTE
DWG.	MYZ	DATE	21.07.02	SIZE	A4 UNITS mm SHEET/OF 1/1
CHK.		DATE		SCALE	1:1
APP.		DATE			
				NAME	GT25C-A-XXP-XX-00
				DWGNO.	XXXX

Golten 宁波冠泰电子有限公司
NINGBO GOLTEN ELECTRONICS CO., LTD.