

REV	CONTENT	CHK	DATE
V0.0	CONTENT	MYZ	21.07.01

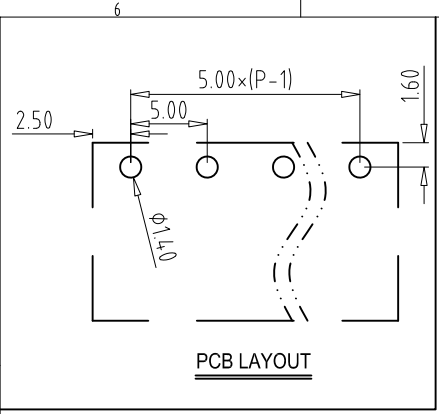

PCB LAYOUT

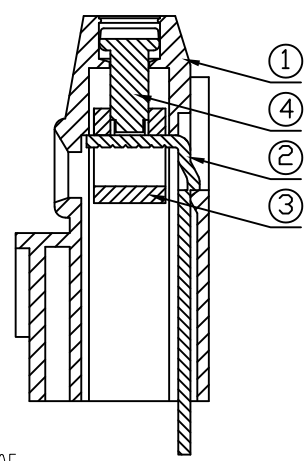
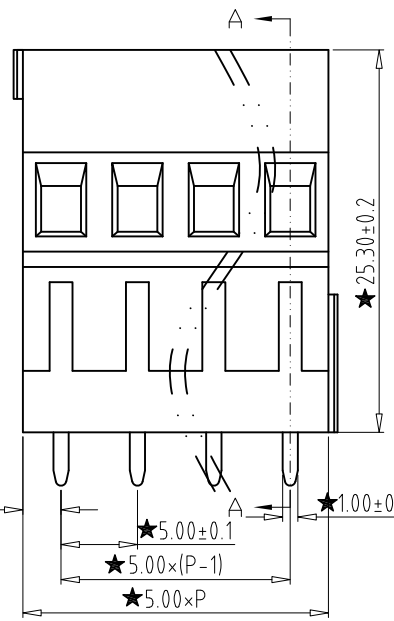
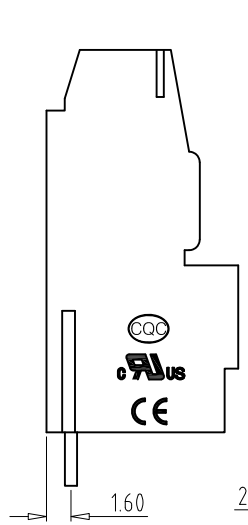
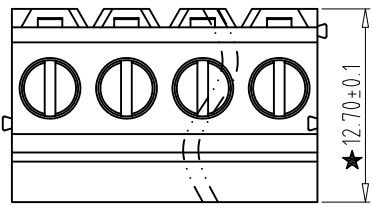

SECTION A-A

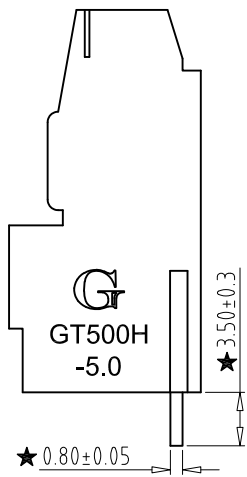

Electrical :

- | | | |
|--|------------------|------------------------|
| | UL | IEC |
| 1.Rated Voltage : | 300V | 250V |
| 2.Rated Current : | 20A | 24A |
| 3.Torque Value : | M2.5 , 3.54Lb.in | M2.5 , 0.4N.m |
| 4.Wire Range: | 28-12AWG | 0.5-2.5mm ² |
| 5.Stripping Length : | 6-7mm | |
| 6.Withstanding Voltage : | AC2000V/1Min. | |
| 7.Operating Temperature : | -40°C~+105°C | |
| 8.RoHS Compliance | | |
| 9.Safety Approval : | RoHS CE | |
| 10."★" is the key quality control point. | | |

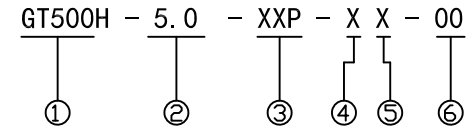

- ① Series No.
- ② Pitch
- ③ Poles
- ④ 1 Single Pitch
2 Double Pitch
- ⑤ Color: 1 Grey
2 Blue
3 Black
4 Green
5 Orange
6 Red
7 Transparent
8 Yellow
9 White
- ⑥ Customer Request : 00--Standard

4	SCREW	XX	P	STEEL	Zn Plated
3	BLOCK	XX	P	BRASS	Ni Plated
2	PIN	XX	P	BRASS	Tin Plated
1	HOUSING	XX	1	PA66 UL94V-0	SEE NOTE
ITEM	NAME OF PART	NO. OF PART	Q'TY	MATERIAL	NOTE
DWG.	MYZ	DATE	21.07.01	SIZE	A4 UNITS mm SHEET/OF 1/1
CHK.		DATE		SCALE	1:1
APP.		DATE		NAME	GT500H-5.0-XXP-XX-00
	NINGBO GOLTEN ELECTRONICS CO., LTD.			DWGNO.	XXXX

Total Pitch Tolerances in mm										Nominal dimension range in mm										⊥	≡	-	//		
over 0	over 30	over 53	over 70	over 90	over 115	over 150	over 250	over 350	over 500	over 0	over 30	over 53	over 70	over 90	over 115	over 150	over 200	over 250	over 320	to 0	to 10	all	to 0	to 100	to 150
±0.18	±0.20	±0.25	±0.3	±0.35	±0.44	±0.60	±0.70	±0.85	±0.20	±0.25	±0.30	±0.35	±0.44	±0.55	±0.70	±0.80	±0.90	0.2	0.3	0.3	0.2	0.3	0.5		