

REVISION RECORD				
REV	ECD	DESCRIPTION	DRFT	DATE
△ 10-004		螺丝由S000001100变更为S000002530	HD	03/13/10*
△ 10-0168		增加UL认证刻字	Jinbai.Lan	06/06/10*

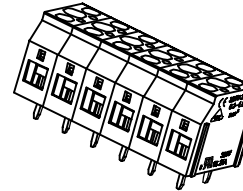

Notes:

1. Pitch:7.5mm ,Poles:1-XXP
2. Rated voltage/current:UL 300V/25A
VDE 320V/32A
3. Operation temperatures:-40℃~+105℃
4. Withstanding Voltage:AC2000V/1Min
5. Insulation Resistance:5000MΩ /DC1000V
6. Wire Range:24~10AWG, 0.2~4.0mm²
7. Max. Torque Value:M3, 5.10Kgf.cm
8. Undimensioned Tolerances:

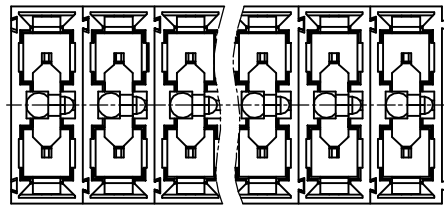
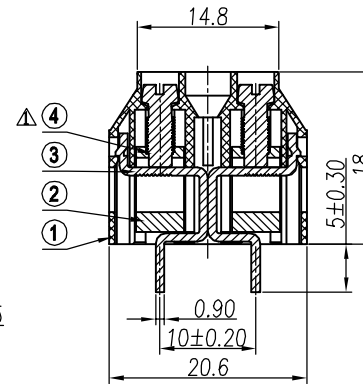
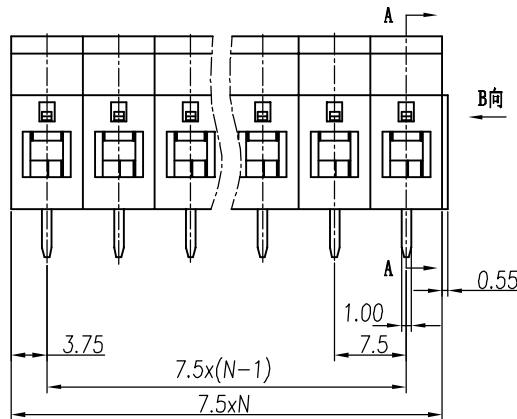
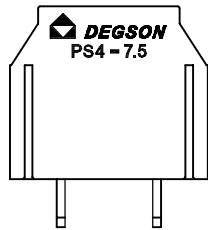

剖面A-A

Pitch range in mm		Nominal dimension range in mm						
to 6	over 6 to 10	over 10 to 24	to 30	over 30 to 60	over 60 to 100	over 100 to 150	—	
±0.10	±0.15	±0.25	±0.2	±0.3	±0.5	±0.7	±1.0	
							0.05/10	

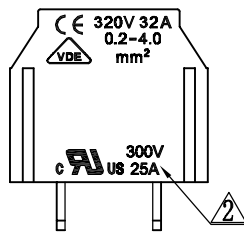

B向视图

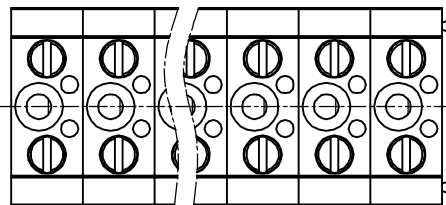

4	TSCB-4-SCREW	△	S000002530 (H)	XX*2	Brass	Ni Plated
3	PS 4-7.5-Pin header		4122B00010 (H)	XX	Copper	Snce plated
2	PCDK 4-Brass Cage		X000001840 (H)	XX*2	Brass	Ni Plated
1	PS 4-7.5-Housing		4122A0Y01A (H)	XX	PA66	UL94V-0

ITEM	NAME OF PART	NO. OF PART	Q'TY	MATERIAL	NOTES																								
<table border="1"> <tr> <td rowspan="4">DETACHED LISTS</td> <td>MM (INCH)</td> <td>DATE 06/02/08*</td> <td colspan="3" rowspan="4"> 宁波高正电子有限公司 DEGSON ELECTRONICS CO., LTD NAME PS4-7.5-XXP-1Y-00A(H) DRAWING NO. PS4-7.5-E01 /PART NO. DO NOT SCALE DRAWING </td> </tr> <tr> <td>TOLERANCES EXCEPT AS NOTED</td> <td>CHKD DATE</td> </tr> <tr> <td>MM .0 ± .00 ± .000 ±</td> <td>APPVL DATE</td> </tr> <tr> <td>ANGLES ± 1°</td> <td>MATERIAL :</td> </tr> <tr> <td></td> <td>FINISH:</td> <td>G.E :</td> <td>SIZE A3</td> <td>REV T2</td> <td></td> </tr> <tr> <td></td> <td>THIRD ANGLE PROJECTION</td> <td>SCALE : 1:1</td> <td></td> <td>06/06/10</td> <td>OF 1</td> </tr> </table>						DETACHED LISTS	MM (INCH)	DATE 06/02/08*	宁波高正电子有限公司 DEGSON ELECTRONICS CO., LTD NAME PS4-7.5-XXP-1Y-00A(H) DRAWING NO. PS4-7.5-E01 /PART NO. DO NOT SCALE DRAWING			TOLERANCES EXCEPT AS NOTED	CHKD DATE	MM .0 ± .00 ± .000 ±	APPVL DATE	ANGLES ± 1°	MATERIAL :		FINISH:	G.E :	SIZE A3	REV T2			THIRD ANGLE PROJECTION	SCALE : 1:1		06/06/10	OF 1
DETACHED LISTS	MM (INCH)	DATE 06/02/08*	宁波高正电子有限公司 DEGSON ELECTRONICS CO., LTD NAME PS4-7.5-XXP-1Y-00A(H) DRAWING NO. PS4-7.5-E01 /PART NO. DO NOT SCALE DRAWING																										
	TOLERANCES EXCEPT AS NOTED	CHKD DATE																											
	MM .0 ± .00 ± .000 ±	APPVL DATE																											
	ANGLES ± 1°	MATERIAL :																											
	FINISH:	G.E :	SIZE A3	REV T2																									
	THIRD ANGLE PROJECTION	SCALE : 1:1		06/06/10	OF 1																								