

ST 2SD1766U

NPN Silicon Epitaxial Planar Transistor

Medium power amplifier

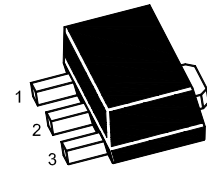

1.Base 2.Collector 3.Emitter
SOT-89 Plastic Package

Absolute Maximum Ratings ($T_a = 25\text{ }^\circ\text{C}$)

Parameter	Symbol	Value	Unit
Collector Base Voltage	V_{CBO}	40	V
Collector Emitter Voltage	V_{CEO}	32	V
Emitter Base Voltage	V_{EBO}	5	V
Collector Current	I_C	2	A
Peak Collector Current (Single pulse, $P_w = 20\text{ ms}$)	I_{CP}	2.5	A
Collector Power Dissipation	P_C	0.5 2 ¹⁾	W
Junction Temperature	T_j	150	$^\circ\text{C}$
Storage Temperature Range	T_{stg}	- 55 to + 150	$^\circ\text{C}$

¹⁾ When mounted on a 40 X 40 X 0.7 mm ceramic board.

Characteristics at $T_a = 25\text{ }^\circ\text{C}$

Parameter	Symbol	Min.	Typ.	Max.	Unit	
DC Current Gain at $V_{CE} = 3\text{ V}$, $I_C = 500\text{ mA}$	Current Gain Group P	h_{FE}	82	-	180	-
	Q	h_{FE}	120	-	270	-
	R	h_{FE}	180	-	390	-
Collector Base Cutoff Current at $V_{CB} = 20\text{ V}$	I_{CBO}	-	-	1	μA	
Emitter Base Cutoff Current at $V_{EB} = 4\text{ V}$	I_{EBO}	-	-	1	μA	
Collector Base Breakdown Voltage at $I_C = 50\text{ }\mu\text{A}$	$V_{(BR)CBO}$	40	-	-	V	
Collector Emitter Breakdown Voltage at $I_C = 1\text{ mA}$	$V_{(BR)CEO}$	32	-	-	V	
Emitter Base Breakdown Voltage at $I_E = 50\text{ }\mu\text{A}$	$V_{(BR)EBO}$	5	-	-	V	
Collector Emitter Saturation Voltage at $I_C = 2\text{ A}$, $I_B = 200\text{ mA}$	$V_{CE(sat)}$	-	-	0.8	V	
Transition Frequency at $V_{CE} = 5\text{ V}$, $-I_E = 500\text{ mA}$, $f = 100\text{ MHz}$	f_T	-	100	-	MHz	
Collector Base Capacitance at $V_{CB} = 10\text{ V}$, $f = 1\text{ MHz}$	C_{ob}	-	30	-	pF	

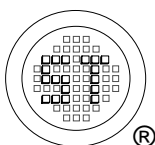

SEMTECH ELECTRONICS LTD.
Subsidiary of Sino-Tech International (BVI) Limited



Dated : 18/08/2009

Fig. 1 $P_C - T_a$

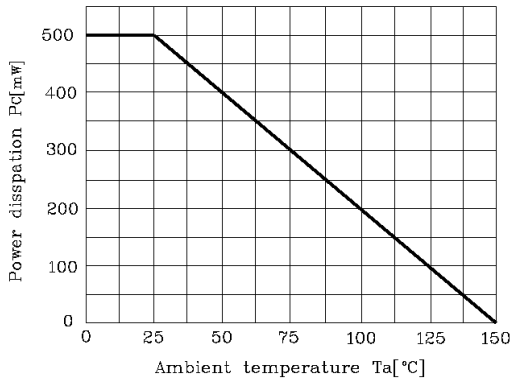

Fig. 2 $I_C - V_{BE}$

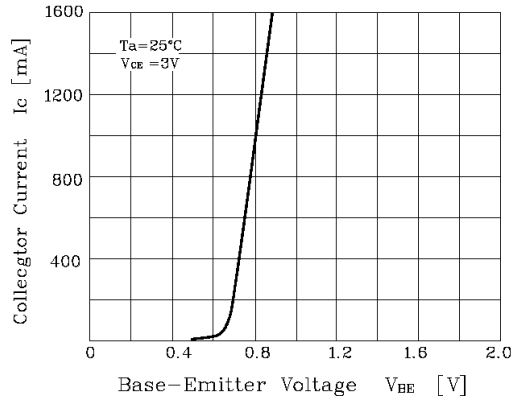

Fig. 3 $I_C - V_{CE}$

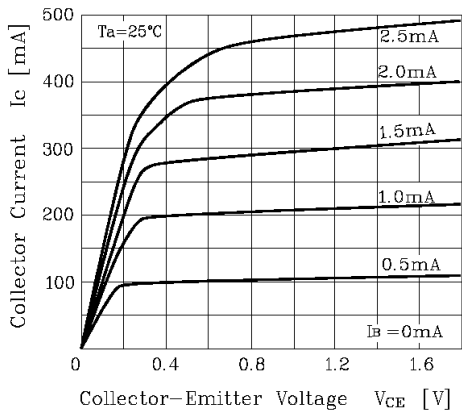

Fig. 4 $V_{CE(sat)} - I_C$

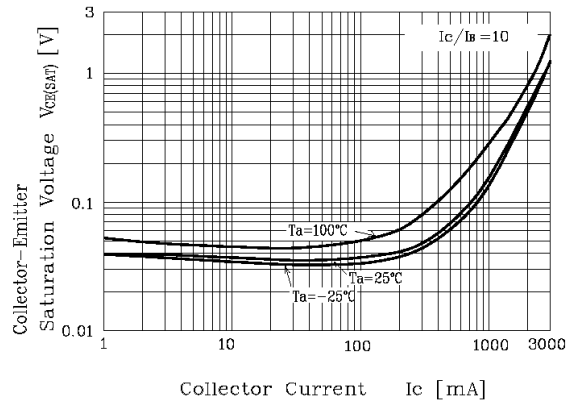
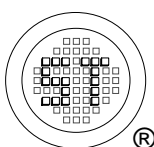
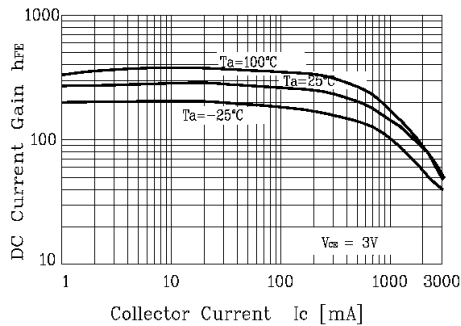

Fig. 5 $h_{FE} - I_C$



SEMTECH ELECTRONICS LTD.
Subsidiary of Sino-Tech International (BVI) Limited



ST 2SD1766U

SOT-89 PACKAGE OUTLINE

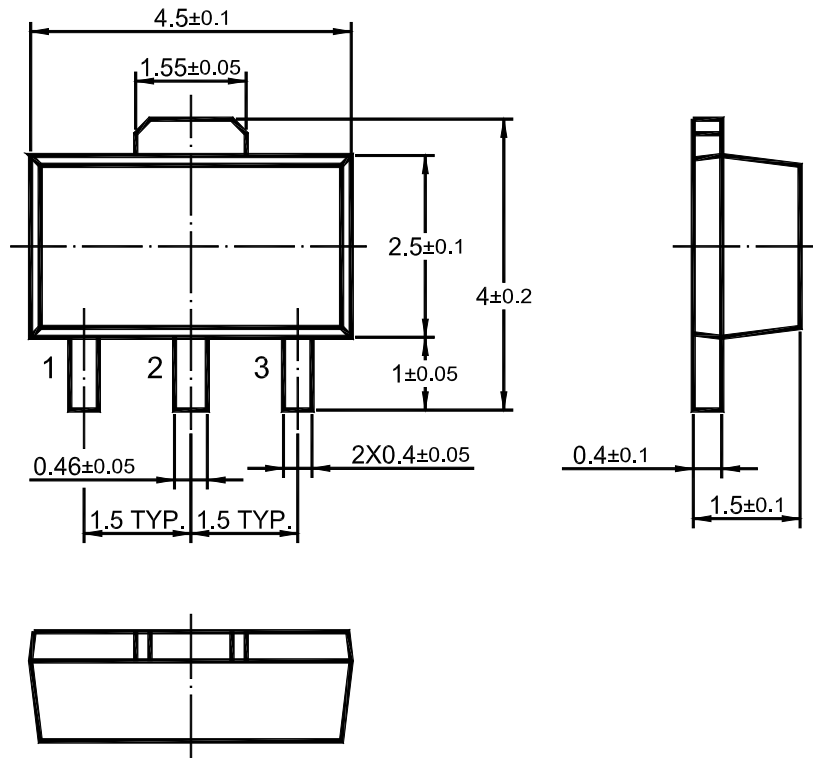

Dimensions in mm

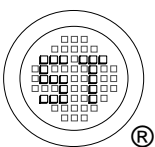

SEMTECH ELECTRONICS LTD.
Subsidiary of Sino-Tech International (BVI) Limited



Dated : 18/08/2009