

# ST TIP31C

## NPN Silicon Epitaxial Planar Transistor

for power switching and amplifier applications

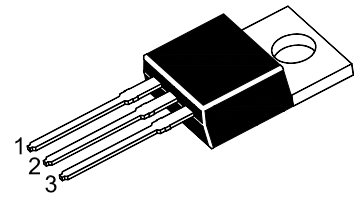

1.Base 2.Collector 3.Emitter  
TO-220 Plastic Package

### Absolute Maximum Ratings ( $T_a = 25\text{ }^\circ\text{C}$ )

Parameter	Symbol	Value	Unit
Collector Base Voltage	$V_{CBO}$	100	V
Collector Emitter Voltage	$V_{CEO}$	100	V
Emitter Base Voltage	$V_{EBO}$	5	V
Collector Current	$I_C$	3	A
Collector Current (Pulse)	$I_{CP}$	5	A
Base Current	$I_B$	1	A
Power Dissipation ( $T_a = 25\text{ }^\circ\text{C}$ )	$P_{tot}$	2	W
Power Dissipation ( $T_c = 25\text{ }^\circ\text{C}$ )	$P_{tot}$	40	W
Junction Temperature	$T_j$	150	$^\circ\text{C}$
Storage Temperature Range	$T_s$	- 65 to + 150	$^\circ\text{C}$

### Characteristics at $T_a = 25\text{ }^\circ\text{C}$

Parameter	Symbol	Min.	Max.	Unit
DC Current Gain at $V_{CE} = 4\text{ V}$ , $I_C = 1\text{ A}$	$h_{FE}$	25	-	-
at $V_{CE} = 4\text{ V}$ , $I_C = 3\text{ A}$	$h_{FE}$	10	50	-
Collector Emitter Cutoff Current at $V_{CE} = 100\text{ V}$	$I_{CES}$	-	0.2	mA
Collector Emitter Cutoff Current at $V_{CE} = 60\text{ V}$	$I_{CEO}$	-	0.3	mA
Emitter Base Cutoff Current at $V_{EB} = 5\text{ V}$	$I_{EBO}$	-	1	mA
Collector Emitter Sustaining Voltage at $I_C = 30\text{ mA}$	$V_{CEO(sus)}$	100	-	V
Collector Emitter Saturation Voltage at $I_C = 3\text{ A}$ , $I_B = 375\text{ mA}$	$V_{CE(sat)}$	-	1.2	V
Base Emitter On Voltage at $V_{CE} = 4\text{ V}$ , $I_C = 3\text{ A}$	$V_{BE(on)}$	-	1.8	V
Transition Frequency at $V_{CE} = 10\text{ V}$ , $I_C = 500\text{ mA}$ , $f = 1\text{ MHz}$	$f_T$	3	-	MHz

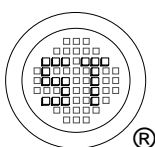

**SEMTECH ELECTRONICS LTD.**  
Subsidiary of Sino-Tech International (BVI) Limited



Dated: 16/04/2012 Rev: 02

# ST TIP31C

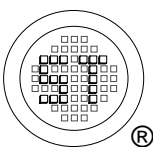
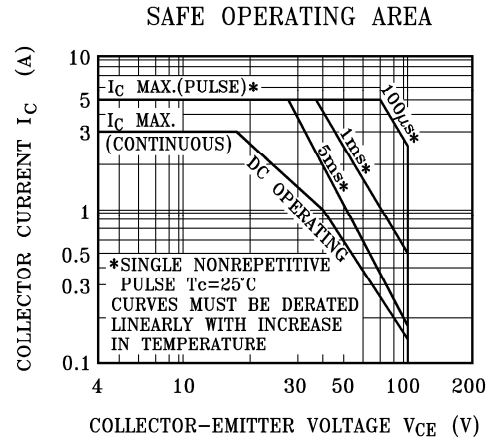
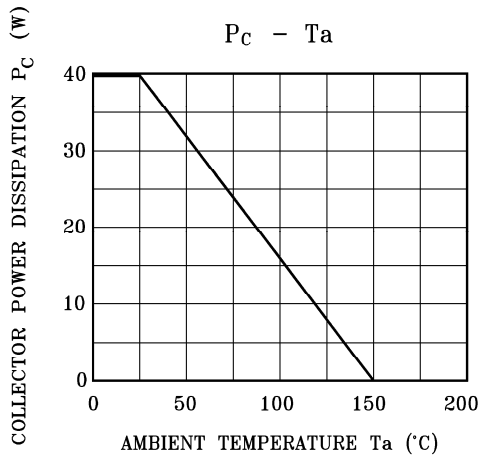
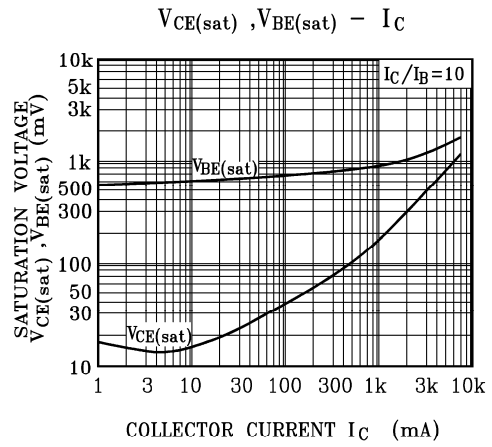
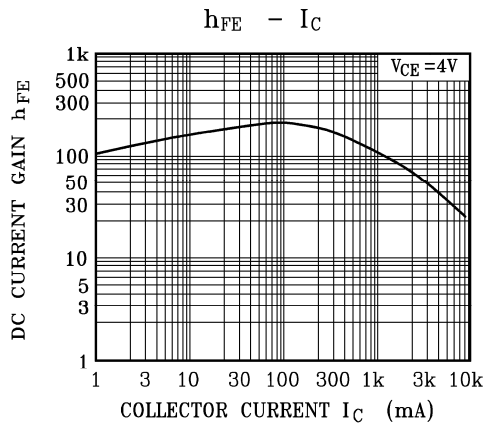

**SEMTECH ELECTRONICS LTD.**  
Subsidiary of Sino-Tech International (BVI) Limited



# ST TIP31C

## TO-220 PACKAGE OUTLINE

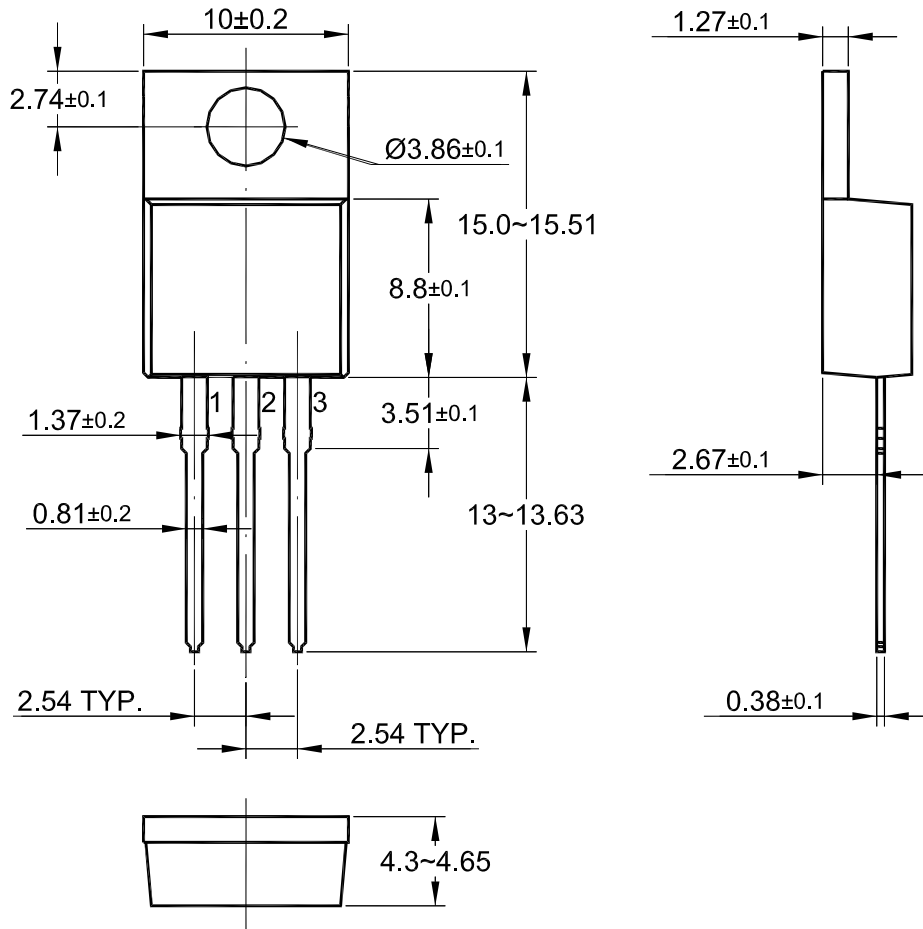

Dimensions in mm

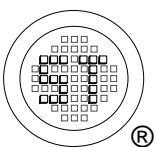

**SEMTECH ELECTRONICS LTD.**  
Subsidiary of Sino-Tech International (BVI) Limited



Dated: 16/04/2012 Rev: 02