

P-Channel Enhancement Mode Field Effect Transistor

FEATURES

- -150V, -2.3A, $R_{DS(ON)} = 240m\Omega$ @ $V_{GS} = -10V$.
 $R_{DS(ON)} = 280m\Omega$ @ $V_{GS} = -6V$.
- Super high dense cell design for extremely low $R_{DS(ON)}$.
- High power and current handling capability.
- RoHS compliant.
- Surface mount Package.

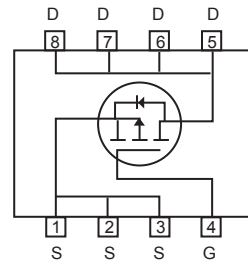

ABSOLUTE MAXIMUM RATINGS $T_A = 25^\circ C$ unless otherwise noted

Parameter	Symbol	Limit	Units
Drain-Source Voltage	V_{DS}	-150	V
Gate-Source Voltage	V_{GS}	± 20	V
Drain Current-Continuous	I_D	-2.3	A
Drain Current-Pulsed ^a	I_{DM}	-9.2	A
Maximum Power Dissipation	P_D	2.5	W
Operating and Store Temperature Range	T_J, T_{stg}	-55 to 150	$^\circ C$

Thermal Characteristics

Parameter	Symbol	Limit	Units
Thermal Resistance, Junction-to-Ambient ^b	$R_{\theta JA}$	50	$^\circ C/W$

Electrical Characteristics $T_C = 25^\circ\text{C}$ unless otherwise noted

Parameter	Symbol	Test Condition	Min	Typ	Max	Units
Off Characteristics						
Drain-Source Breakdown Voltage	BV_{DSS}	$V_{GS} = 0V, I_D = -250\mu A$		-150		V
Zero Gate Voltage Drain Current	I_{DSS}	$V_{DS} = -135V, V_{GS} = 0V$			-1	μA
Gate Body Leakage Current, Forward	I_{GSSF}	$V_{GS} = 20V, V_{DS} = 0V$			100	nA
Gate Body Leakage Current, Reverse	I_{GSSR}	$V_{GS} = -20V, V_{DS} = 0V$			-100	nA
On Characteristics^b						
Gate Threshold Voltage	$V_{GS(th)}$	$V_{GS} = V_{DS}, I_D = -250\mu A$	-2		-4	V
Static Drain-Source On-Resistance	$R_{DS(on)}$	$V_{GS} = -10V, I_D = -2A$		200	240	$m\Omega$
		$V_{GS} = -6V, I_D = -1A$		215	280	$m\Omega$
Dynamic Characteristics^c						
Input Capacitance	C_{iss}	$V_{DS} = -30V, V_{GS} = 0V,$ $f = 1.0\text{ MHz}$		1115		pF
Output Capacitance	C_{oss}			165		pF
Reverse Transfer Capacitance	C_{rss}			35		pF
Switching Characteristics^c						
Turn-On Delay Time	$t_{d(on)}$	$V_{DD} = -120V, I_D = -2A,$ $V_{GS} = -10V, R_{GEN} = 6\Omega$		21		ns
Turn-On Rise Time	t_r			7		ns
Turn-Off Delay Time	$t_{d(off)}$			64		ns
Turn-Off Fall Time	t_f			7		ns
Total Gate Charge	Q_g				33	
Gate-Source Charge	Q_{gs}	$V_{DS} = -120V, I_D = -2A,$ $V_{GS} = -10V$		5		nC
Gate-Drain Charge	Q_{gd}			12		nC
Drain-Source Diode Characteristics and Maximum Ratings						
Drain-Source Diode Forward Current	I_S				-2	A
Drain-Source Diode Forward Voltage ^b	V_{SD}	$V_{GS} = 0V, I_S = -2A$			-1.2	V

Notes :

a.Repetitive Rating : Pulse width limited by maximum junction temperature.

b.Pulse Test : Pulse Width $\leq 300\mu s$, Duty Cycle $\leq 2\%$.

c.Guaranteed by design, not subject to production testing.

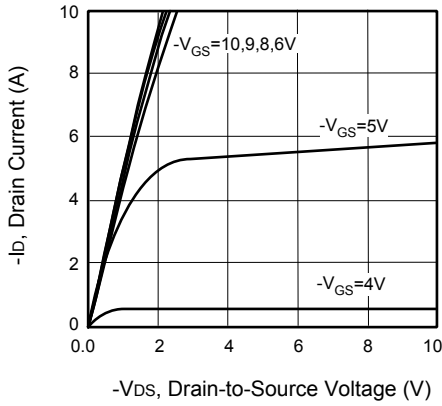

Figure 1. Output Characteristics

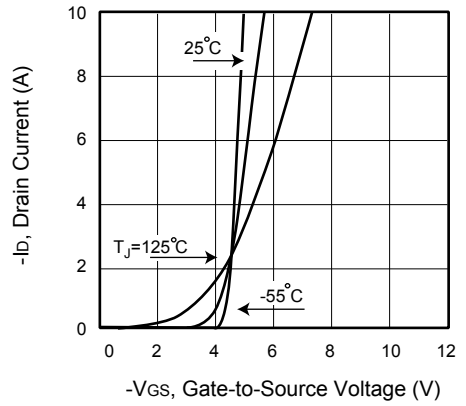

Figure 2. Transfer Characteristics

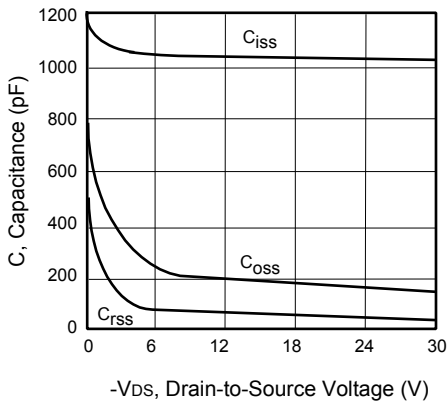

Figure 3. Capacitance

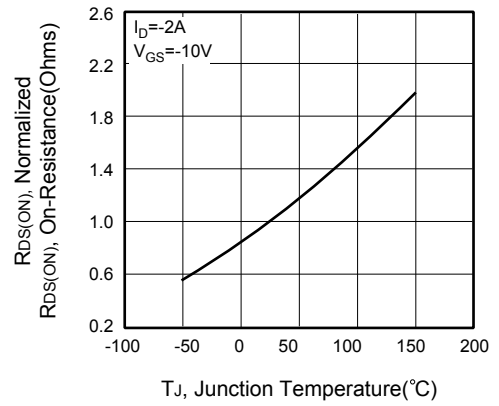

Figure 4. On-Resistance Variation with Temperature

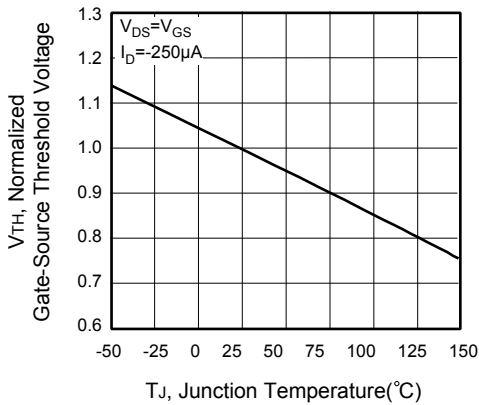

Figure 5. Gate Threshold Variation with Temperature

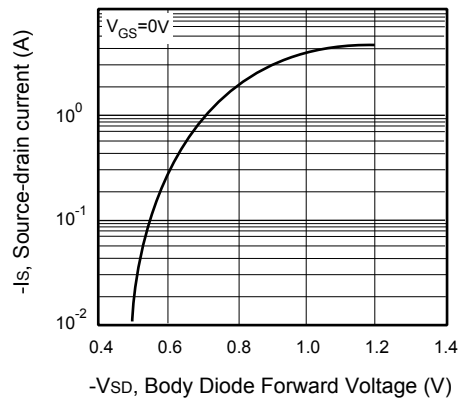

Figure 6. Body Diode Forward Voltage Variation with Source Current

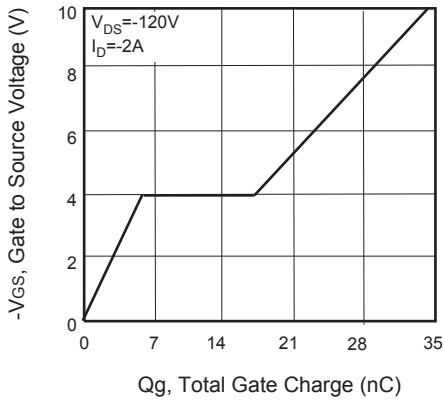

Figure 7. Gate Charge

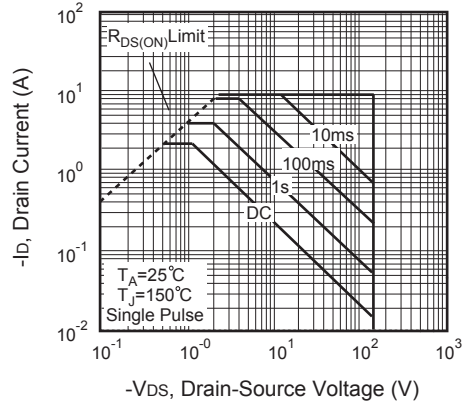

Figure 8. Maximum Safe Operating Area

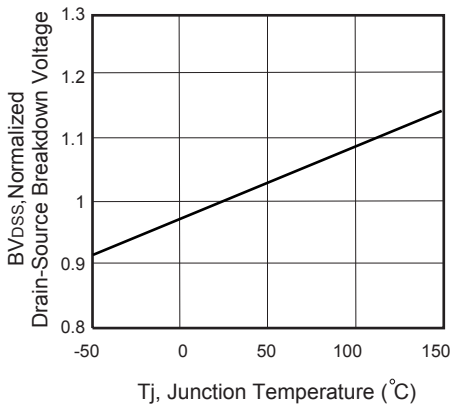

Figure 9. Breakdown Voltage Variation VS Temperature

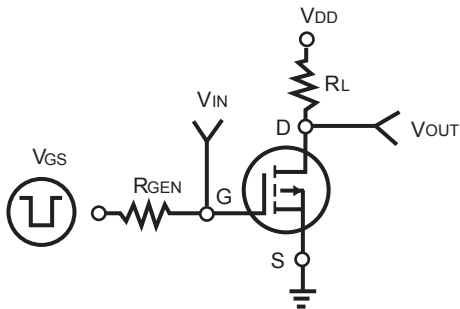

Figure 10. Switching Test Circuit

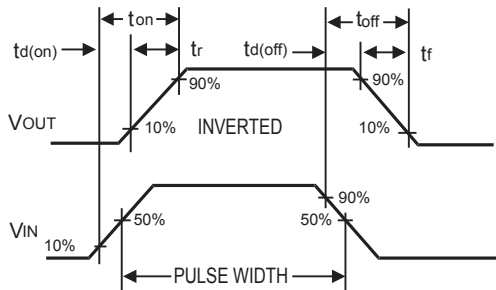

Figure 11. Switching Waveforms

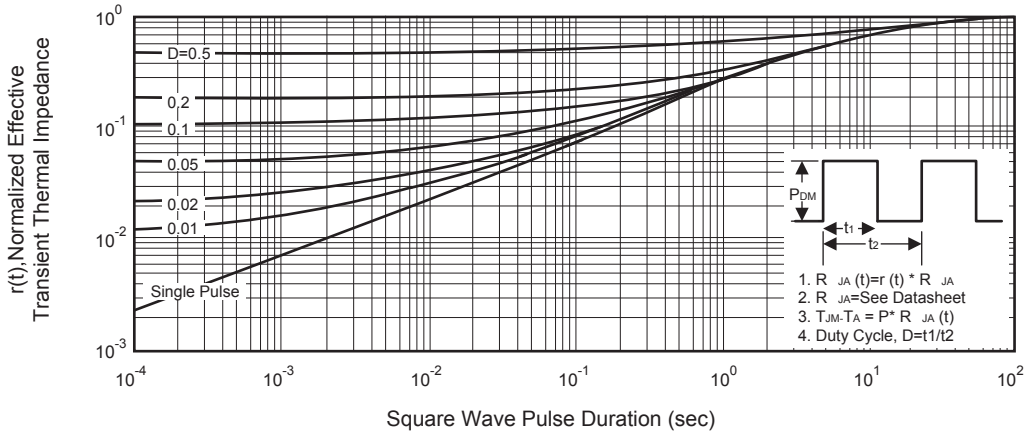

Figure 12. Normalized Thermal Transient Impedance Curve