



CEP170N10S/CEB170N10S CEF170N10S

N-Channel Enhancement Mode Field Effect Transistor

FEATURES

Type	V _{DSS}	R _{DS(ON)}	I _D	@V _{GS}
CEP170N10S	100V	3.7mΩ	168A	10V
CEB170N10S	100V	3.7mΩ	168A	10V
CEF170N10S	100V	3.7mΩ	168A ^d	10V

- Super high dense cell design for extremely low R_{DS(ON)}.
- High power and current handling capability.
- RoHS compliant.

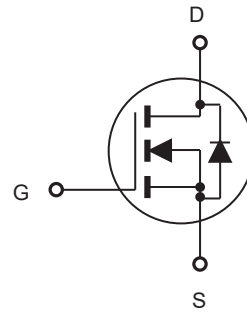
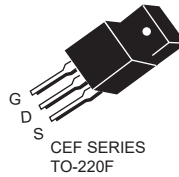
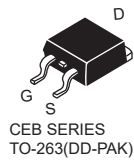

ABSOLUTE MAXIMUM RATINGS $T_C = 25^\circ\text{C}$ unless otherwise noted

Parameter	Symbol	Limit		Units
		TO-220/263	TO-220F	
Drain-Source Voltage	V _{DS}	100		V
Gate-Source Voltage	V _{GS}	± 20		V
Drain Current-Continuous @ T _C = 25°C @ T _C = 100°C	I _D	168	168 ^d	A
		119	119 ^d	A
Drain Current-Pulsed ^a	I _{DM} ^e	672	672 ^d	A
Maximum Power Dissipation @ T _C = 25°C - Derate above 25°C	P _D	188	58	W
		1.25	0.39	W/°C
Single Pulsed Avalanche Energy ^h	E _{AS}	684.5		mJ
Single Pulsed Avalanche Current ^h	I _{AS}	37		A
Operating and Store Temperature Range	T _J , T _{stg}	-55 to 175		°C

Thermal Characteristics

Parameter	Symbol	Limit		Units
Thermal Resistance, Junction-to-Case	R _{θJC}	0.8	2.6	°C/W
Thermal Resistance, Junction-to-Ambient	R _{θJA}	62.5	65	°C/W



CEP170N10S/CEB170N10S CEF170N10S

Electrical Characteristics $T_C = 25^\circ\text{C}$ unless otherwise noted

Parameter	Symbol	Test Condition	Min	Typ	Max	Units
Off Characteristics						
Drain-Source Breakdown Voltage	BV_{DSS}	$V_{GS} = 0V, I_D = 250\mu A$	100			V
Zero Gate Voltage Drain Current	I_{DSS}	$V_{DS} = 100V, V_{GS} = 0V$			1	μA
Gate Body Leakage Current, Forward	I_{GSSF}	$V_{GS} = 20V, V_{DS} = 0V$			100	nA
Gate Body Leakage Current, Reverse	I_{GSSR}	$V_{GS} = -20V, V_{DS} = 0V$			-100	nA
On Characteristics^b						
Gate Threshold Voltage	$V_{GS(th)}$	$V_{GS} = V_{DS}, I_D = 250\mu A$	2		4	V
Static Drain-Source On-Resistance	$R_{DS(on)}$	$V_{GS} = 10V, I_D = 20A$		3.1	3.7	$m\Omega$
		$V_{GS} = 10V, I_D = 100A$		3.2	3.8	$m\Omega$
Dynamic Characteristics^c						
Input Capacitance	C_{iss}	$V_{DS} = 50V, V_{GS} = 0V,$ $f = 1.0\text{ MHz}$		3230		pF
Output Capacitance	C_{oss}			895		pF
Reverse Transfer Capacitance	C_{rss}			45		pF
Switching Characteristics^c						
Turn-On Delay Time	$t_{d(on)}$	$V_{DD} = 50V, I_D = 20A,$ $V_{GS} = 10V, R_{GEN} = 10\Omega$		38		ns
Turn-On Rise Time	t_r			30		ns
Turn-Off Delay Time	$t_{d(off)}$			86		ns
Turn-Off Fall Time	t_f			61		ns
Total Gate Charge	Q_g	$V_{DS} = 50V, I_D = 20A,$ $V_{GS} = 10V$		88		nC
Gate-Source Charge	Q_{gs}			17		nC
Gate-Drain Charge	Q_{gd}			31		nC
Drain-Source Diode Characteristics and Maximum Ratings						
Drain-Source Diode Forward Current	I_S^f				125	A
Drain-Source Diode Forward Voltage ^b	V_{SD}	$V_{GS} = 0V, I_S = 10A^g$			1.5	V
Reverse Recovery Time	T_{rr}	$V_R = 80V, I_F = 10A,$ $di_F/dt = 100A/\mu s$		55		ns
Reverse Recovery Charge	Q_{rr}			420		nC
Notes : a.Repetitive Rating : Pulse width limited by maximum junction temperature . b.Pulse Test : Pulse Width $\leq 300\mu s$, Duty Cycle $\leq 2\%$. c.Guaranteed by design, not subject to production testing. d.Limited only by maximum temperature allowed . e.Pulse width limited by safe operating area . f.Full package $I_{S(max)} = 93A$. g.Full package V_{SD} test condition $I_S = 93A$. h.L = 1mH, $I_{AS} = 37A, V_{DD} = 50V, R_G = 25\Omega$, Starting $T_J = 25\text{ C}$.						



CEP170N10S/CEB170N10S CEF170N10S

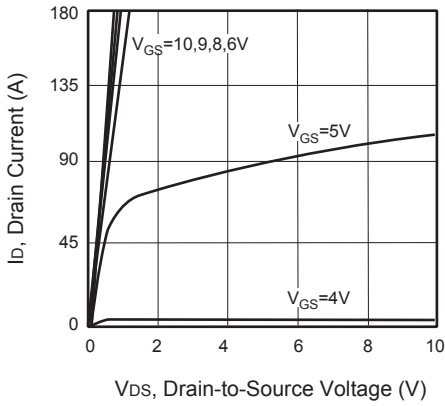

Figure 1. Output Characteristics

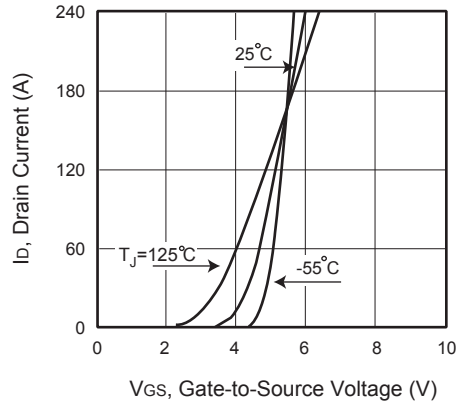

Figure 2. Transfer Characteristics

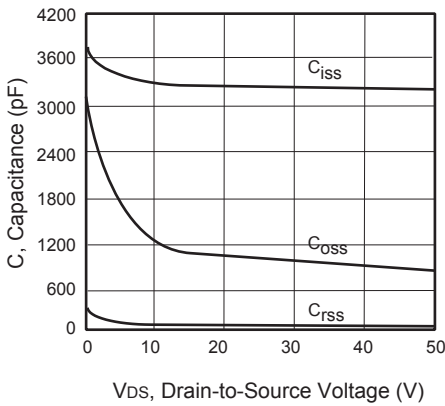

Figure 3. Capacitance

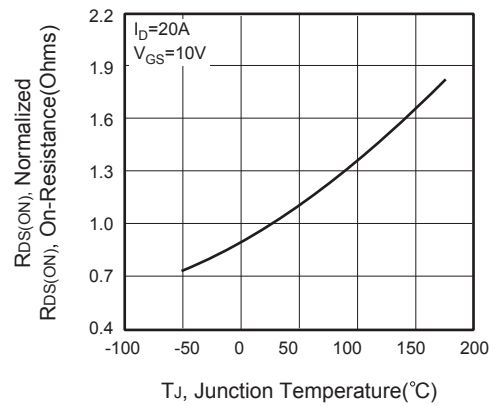

Figure 4. On-Resistance Variation with Temperature



Figure 5. Gate Threshold Variation with Temperature

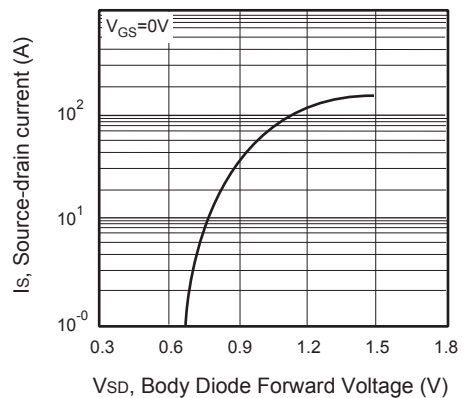

Figure 6. Body Diode Forward Voltage Variation with Source Current



CEP170N10S/CEB170N10S CEF170N10S

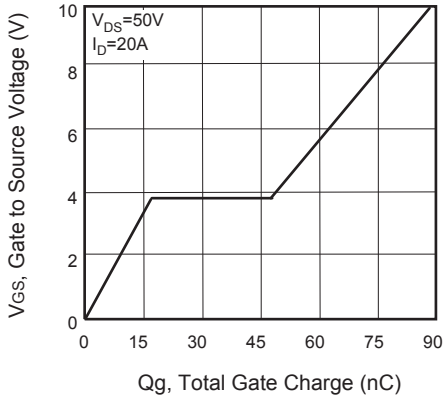

Figure 7. Gate Charge

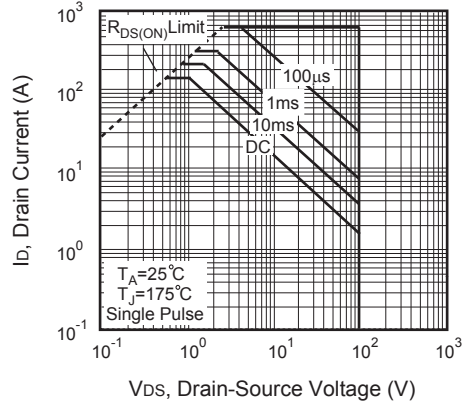

Figure 8. Maximum Safe Operating Area

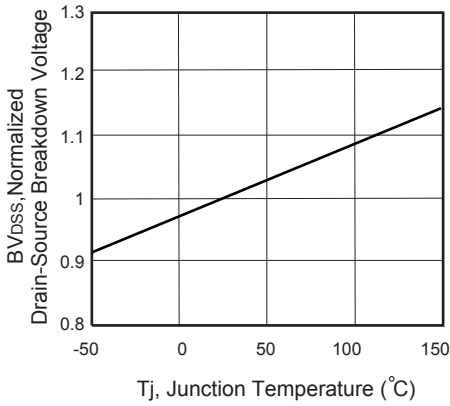

Figure 9. Breakdown Voltage Variation VS Temperature

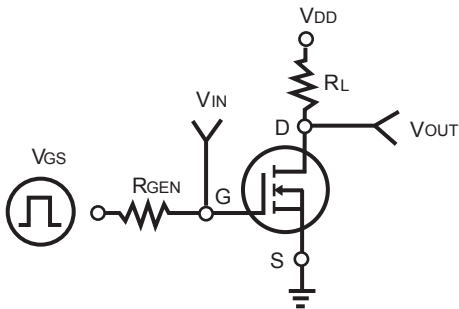

Figure 10. Switching Test Circuit

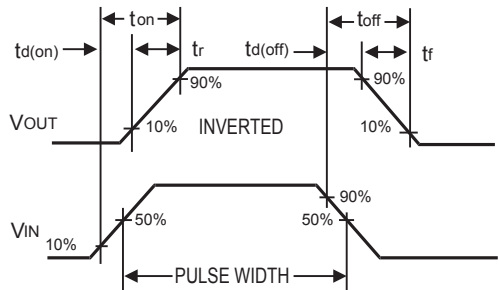

Figure 11. Switching Waveforms



CEP170N10S/CEB170N10S CEF170N10S

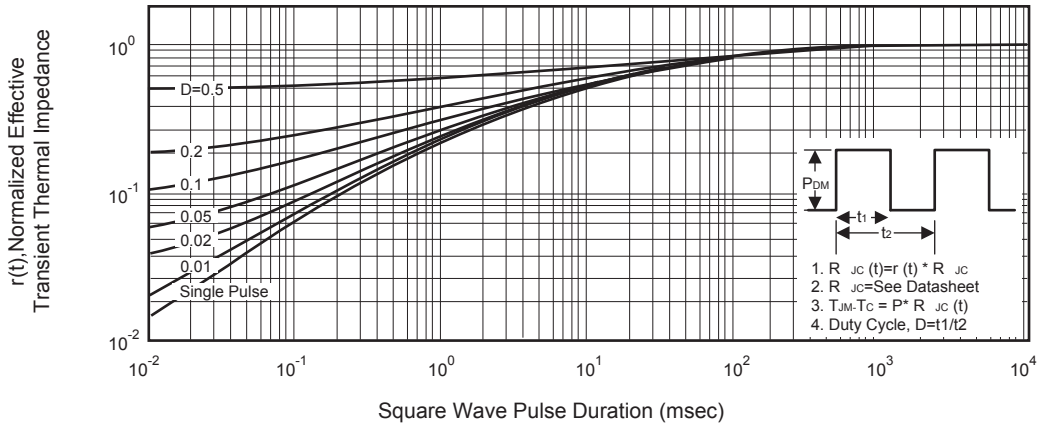

Figure 12. Normalized Thermal Transient Impedance Curve