

LOW VOLTAGE MOSFET (N-CHANNEL)

FEATURES

- Ultra low on-resistance: $V_{DS}=40V, R_{DS(ON)}=56m\Omega @ V_{GS}=10V, I_D=3.6A$
- For Low power DC to DC converter application
- For Load switch application
- Surface Mount device

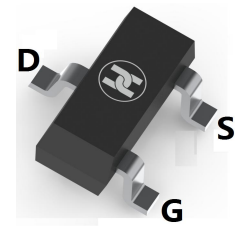

SOT-23

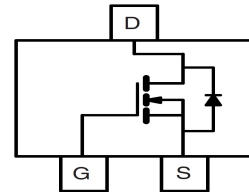

MECHANICAL DATA

- Case: SOT-23
- Case Material: Molded Plastic. UL flammability
- Classification Rating: 94V-0
- Weight: 0.008 grams (approximate)

MAXIMUM RATINGS ($T_A = 25^\circ\text{C}$ unless otherwise noted)

Symbol	Parameter	Max.	Units
V_{DS}	Drain-Source Voltage	40	V
$I_D @ T_A = 25^\circ\text{C}$	Continuous Drain Current, $V_{GS} @ 10V$	3.6	A
$I_D @ T_A = 70^\circ\text{C}$	Continuous Drain Current, $V_{GS} @ 10V$	2.9	
I_{DM}	Pulsed Drain Current	15	
$P_D @ T_A = 25^\circ\text{C}$	Maximum Power Dissipation	1.3	W
$P_D @ T_A = 70^\circ\text{C}$	Maximum Power Dissipation	0.8	
	Linear Derating Factor	0.01	W/ $^\circ\text{C}$
V_{GS}	Gate-to-Source Voltage	± 16	V
T_J, T_{STG}	Junction and Storage Temperature Range	-55 to +150	$^\circ\text{C}$
$R_{\theta JA}$	Junction-to-Ambient ^③	100	$^\circ\text{C/W}$
$R_{\theta JA}$	Junction-to-Ambient ($t < 10s$)	99	

Electric Characteristics @ $T_J = 25^\circ\text{C}$ (unless otherwise specified)

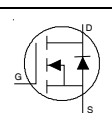
Symbol	Parameter	Min.	Typ.	Max.	Units	Conditions
$V_{(BR)DSS}$	Drain-to-Source Breakdown Voltage	40	—	—	V	$V_{GS} = 0V, I_D = 250\mu A$
$\Delta V_{(BR)DSS}/\Delta T_J$	Breakdown Voltage Temp. Coefficient	—	0.04	—	V/ $^\circ\text{C}$	Reference to $25^\circ\text{C}, I_D = 1mA$
$R_{DS(on)}$	Static Drain-to-Source On-Resistance	—	44	56	m Ω	$V_{GS} = 10V, I_D = 3.6A$ ^②
		—	62	78		$V_{GS} = 4.5V, I_D = 2.9A$ ^②
$V_{GS(th)}$	Gate Threshold Voltage	1.0	1.8	2.5	V	$V_{DS} = V_{GS}, I_D = 25\mu A$
I_{DSS}	Drain-to-Source Leakage Current	—	—	20	μA	$V_{DS} = 40V, V_{GS} = 0V$
		—	—	250		$V_{DS} = 40V, V_{GS} = 0V, T_J = 125^\circ\text{C}$
I_{GSS}	Gate-to-Source Forward Leakage	—	—	100	nA	$V_{GS} = 16V$
	Gate-to-Source Reverse Leakage	—	—	-100		$V_{GS} = -16V$
R_G	Internal Gate Resistance	—	1.1	—	Ω	
g_{fs}	Forward Transconductance	6.2	—	—	S	$V_{DS} = 10V, I_D = 3.6A$
Q_g	Total Gate Charge	—	2.6	3.9	nC	$I_D = 3.6A$
Q_{gs}	Gate-to-Source Charge	—	0.7	—		$V_{DS} = 20V$
Q_{gd}	Gate-to-Drain ("Miller") Charge	—	1.4	—		$V_{GS} = 4.5V$ ^②
$t_{d(on)}$	Turn-On Delay Time	—	5.1	—	ns	$V_{DD} = 20V$
t_r	Rise Time	—	5.4	—		$I_D = 1.0A$
$t_{d(off)}$	Turn-Off Delay Time	—	6.4	—		$R_G = 6.8\ \Omega$
t_f	Fall Time	—	4.3	—		$V_{GS} = 4.5V$
C_{iss}	Input Capacitance	—	266	—	pF	$V_{GS} = 0V$
C_{oss}	Output Capacitance	—	49	—		$V_{DS} = 25V$
C_{rss}	Reverse Transfer Capacitance	—	29	—		$f = 1.0MHz$
I_S	Continuous Source Current (Body Diode)	—	—	1.3	A	MOSFET symbol showing the integral reverse p-n junction diode. 
I_{SM}	Pulsed Source Current (Body Diode) ^①	—	—	15		
V_{SD}	Diode Forward Voltage	—	—	1.2	V	$T_J = 25^\circ\text{C}, I_S = 1.3A, V_{GS} = 0V$ ^②
t_{rr}	Reverse Recovery Time	—	10	—	ns	$T_J = 25^\circ\text{C}, V_R = 32V, I_F = 1.3A$
Q_{rr}	Reverse Recovery Charge	—	9.3	—	nC	$di/dt = 100A/\mu s$ ^②

Notes: ^① Repetitive rating; pulse width limited by max. junction temperature.

^② Pulse width $\leq 400\mu s$; duty cycle $\leq 2\%$.

^③ Surface mounted on 1 in square Cu board

LOW VOLTAGE MOSFET (N-CHANNEL)

Typical Characteristics

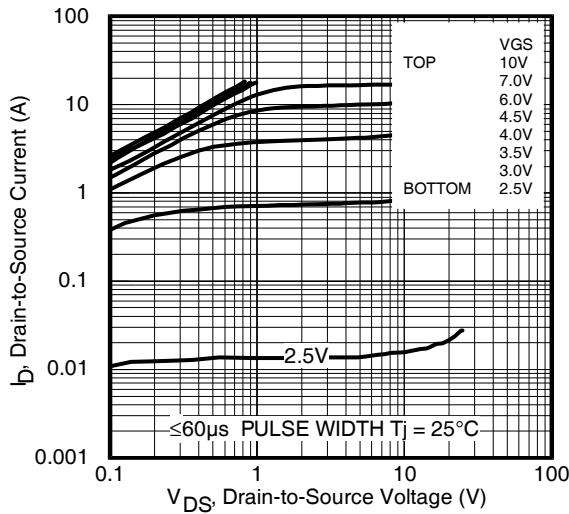

Fig 1. Typical Output Characteristics

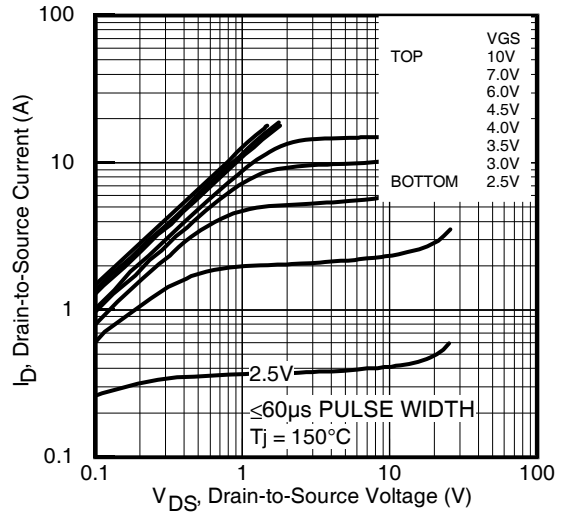

Fig 2. Typical Output Characteristics

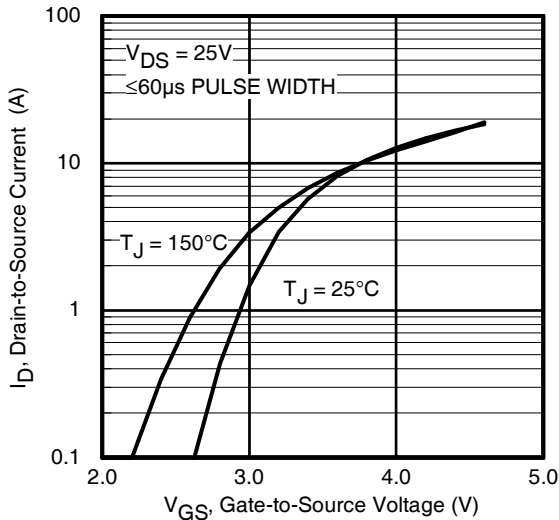

Fig 3. Typical Transfer Characteristics

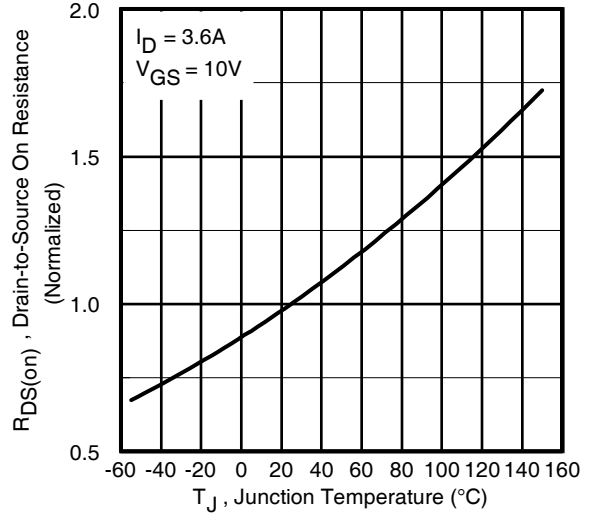

Fig 4. Normalized On-Resistance Vs. Temperature

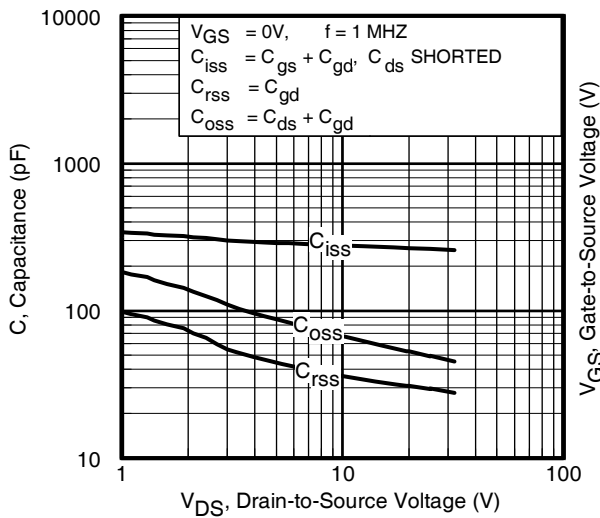

Fig 5. Typical Capacitance Vs. Drain-to-Source Voltage

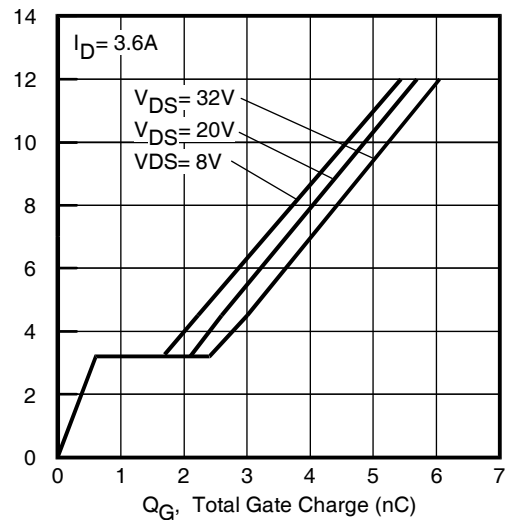

Fig 6. Typical Gate Charge Vs. Gate-to-Source Voltage

LOW VOLTAGE MOSFET (N-CHANNEL)

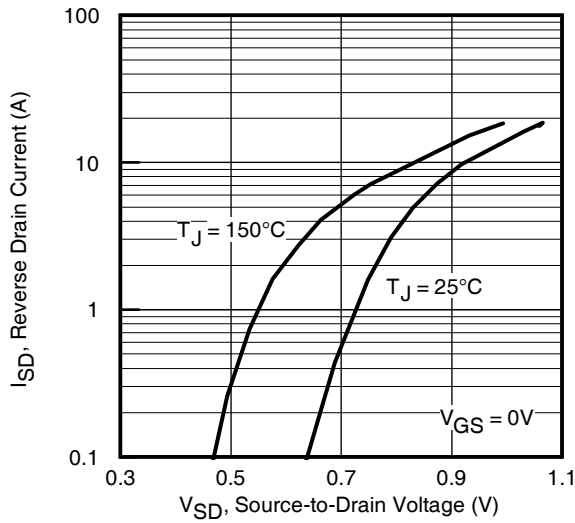

Fig 7. Typical Source-Drain Diode Forward Voltage

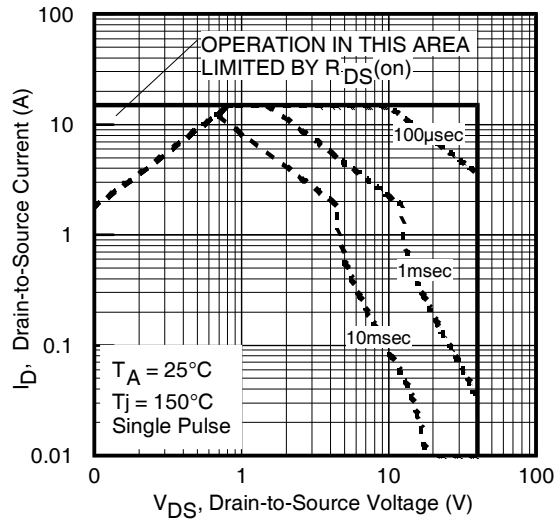

Fig 8. Maximum Safe Operating Area

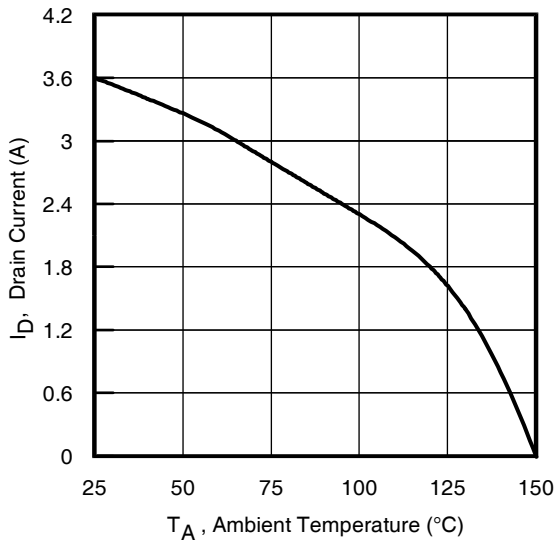

Fig 9. Maximum Drain Current Vs. Ambient Temperature

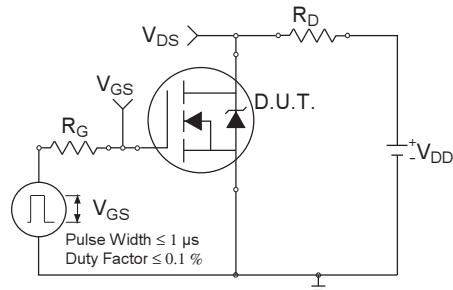

Fig 10a. Switching Time Test Circuit

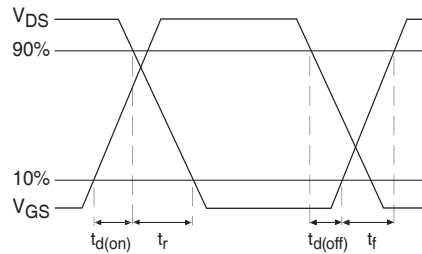

Fig 10b. Switching Time Waveforms

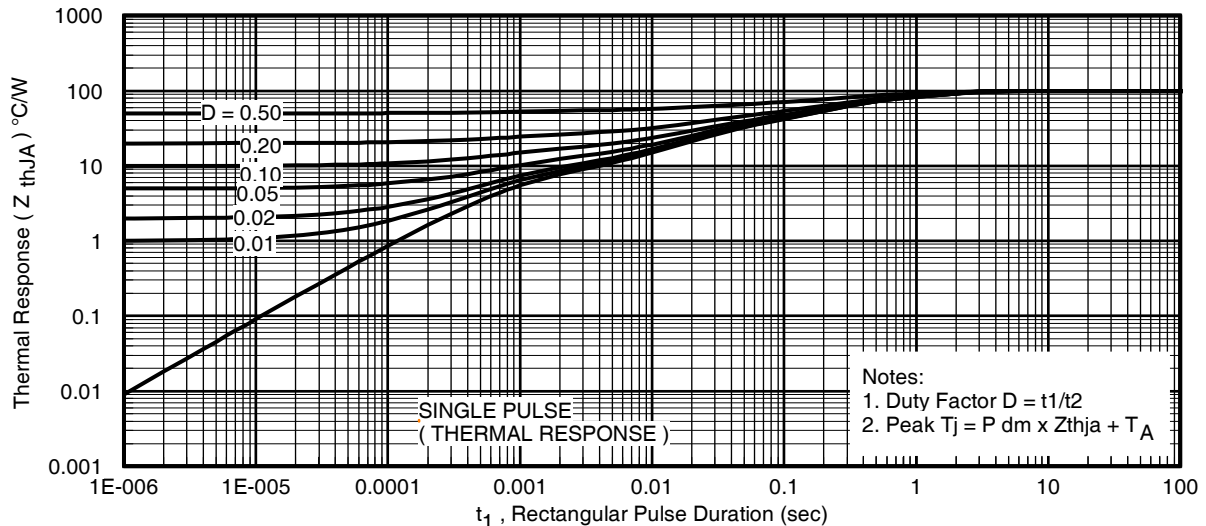

Fig 11. Typical Effective Transient Thermal Impedance, Junction-to-Ambient

Notes:
1. Duty Factor $D = t_1/t_2$
2. Peak $T_J = P_{dm} \times Z_{thja} + T_A$

LOW VOLTAGE MOSFET (N-CANNEL)

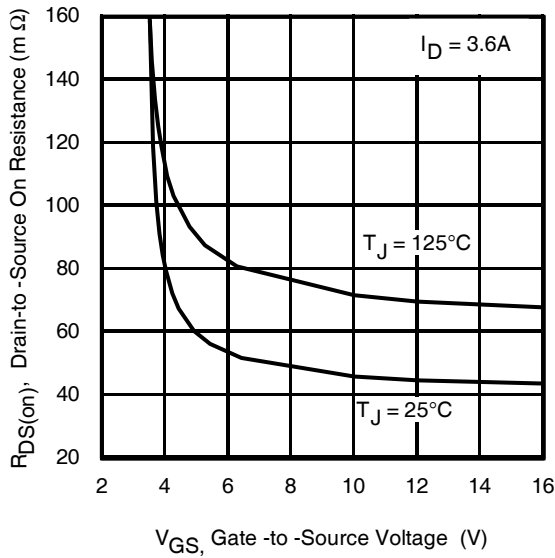

Fig 12. Typical On-Resistance Vs. Gate Voltage

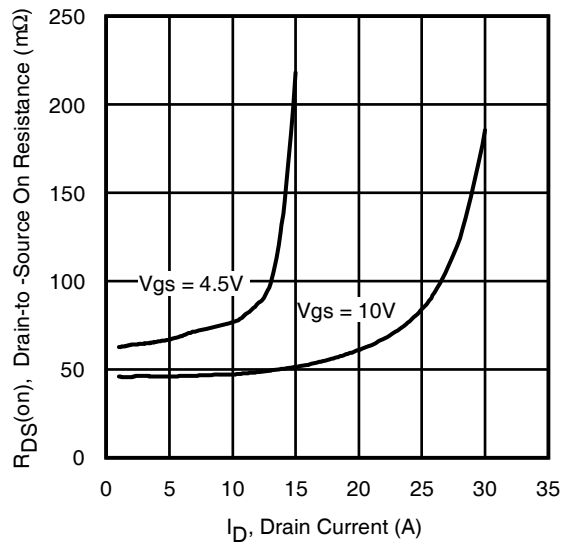

Fig 13. Typical On-Resistance Vs. Drain Current

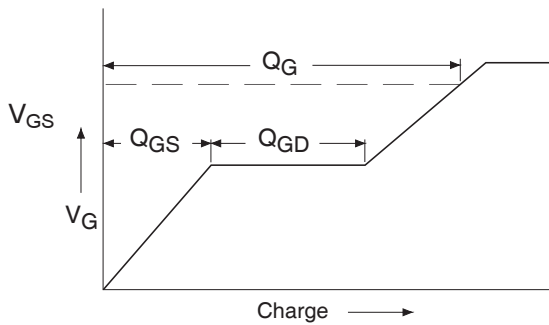

Fig 14a. Basic Gate Charge Waveform

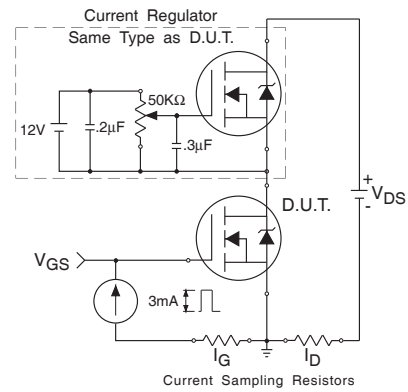

Fig 14b. Gate Charge Test Circuit

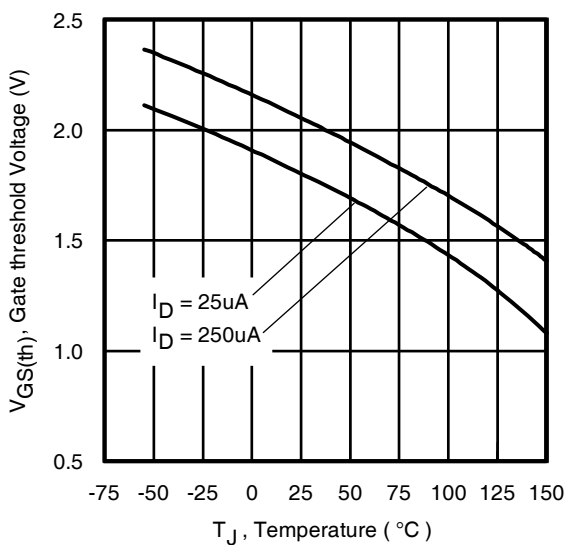

Fig 15. Typical Threshold Voltage Vs. Junction Temperature

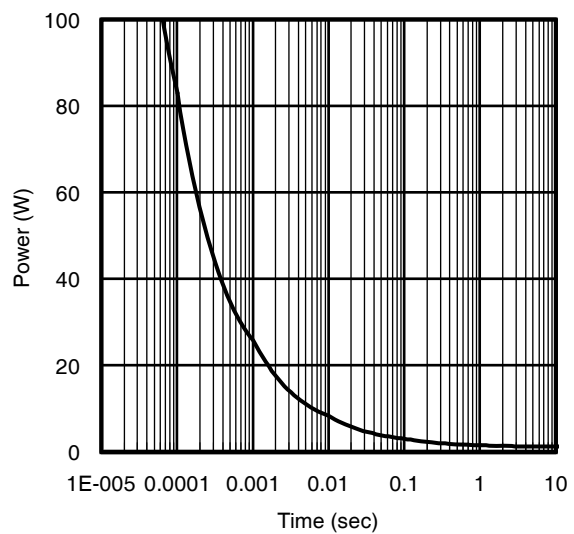
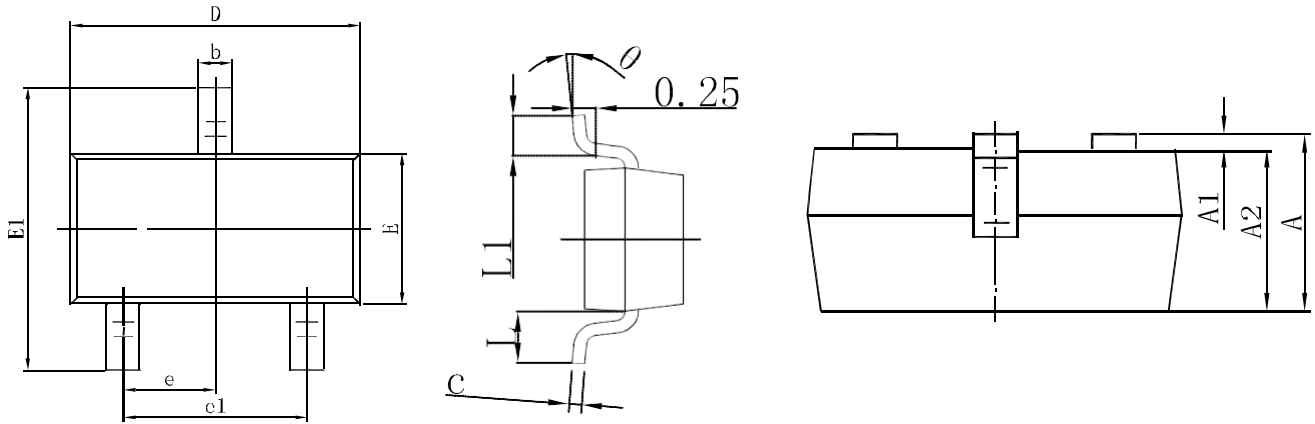

Fig 16. Typical Power Vs. Time

LOW VOLTAGE MOSFET (N-CHANNEL)

SOT-23 Package Outline Dimensions



Symbol	Dimensions In Millimeters		Dimensions In Inches	
	Min.	Max.	Min.	Max.
A	0.900	1.150	0.035	0.045
A1	0.000	0.100	0.000	0.004
A2	0.900	1.050	0.035	0.041
b	0.300	0.500	0.012	0.020
c	0.080	0.150	0.003	0.006
D	2.800	3.000	0.110	0.118
E	1.200	1.400	0.047	0.055
E1	2.250	2.550	0.089	0.100
e	0.950 TYP		0.037 TYP	
e1	1.800	2.000	0.071	0.079
L	0.550 REF		0.022 REF	
L1	0.300	0.500	0.012	0.020
θ	0°	8°	0°	8°

SOT-23 Suggested Pad Layout

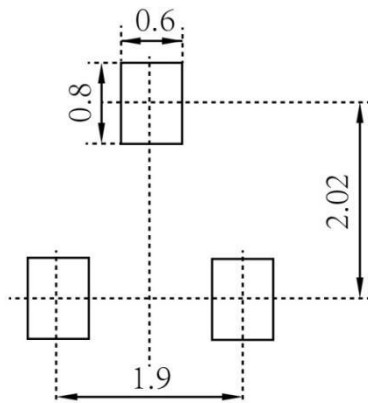

Note:

1. Controlling dimension: in millimeters
2. General tolerance: ±0.05mm
3. The pad layout is for reference purposes only

LOW VOLTAGE MOSFET (N-CHANNEL)

SOT-23 Tape and Reel

SOT-23 Embossed Carrier Tape

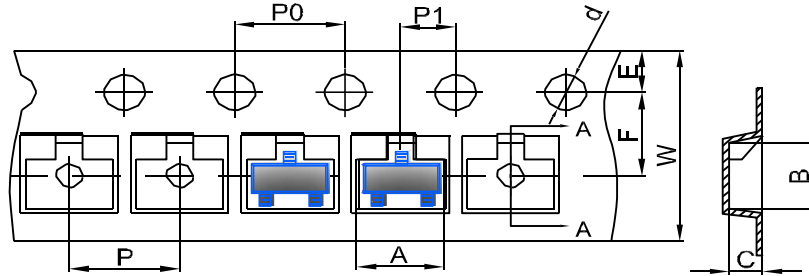

DIMENSIONS ARE IN MILLIMETER										
TYPE	A	B	C	d	E	F	P0	P	P1	W
SOT-23	3.15	2.77	1.22	Ø1.50	1.75	3.50	4.00	4.00	2.00	8.00
TOLERANCE	±0.1	±0.1	±0.1	±0.1	±0.1	±0.1	±0.1	±0.1	±0.1	±0.1

SOT-23 Tape Leader and Trailer

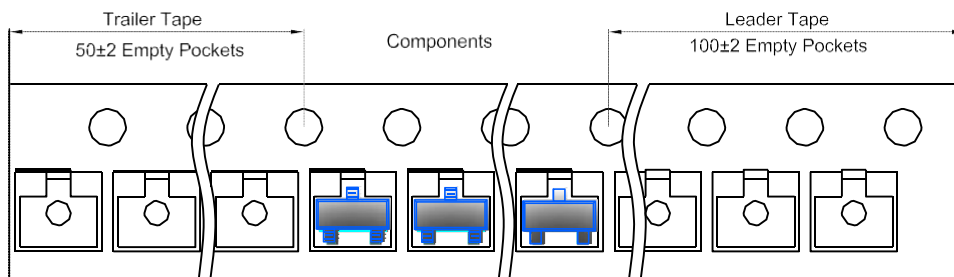

SOT-23 Reel

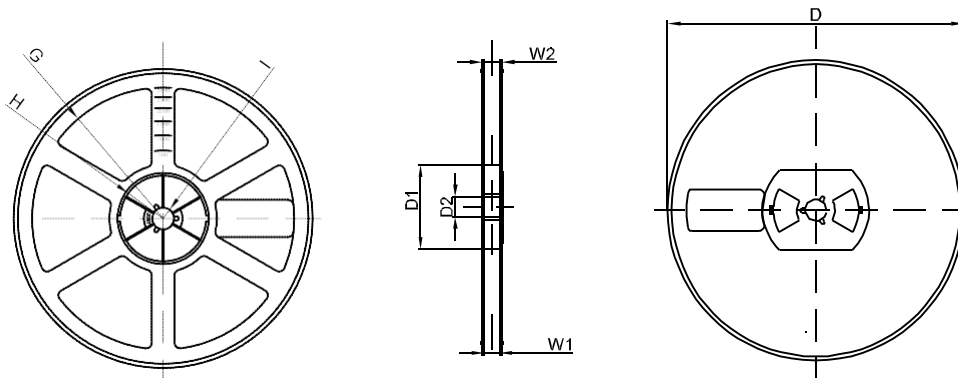

DIMENSIONS ARE IN MILLIMETER								
REEL OPTION	D	D1	D2	G	H	I	W1	W2
7" DIA	Ø178	54.40	13.00	R78	R25.60	R6.50	9.50	12.30
TOLERANCE	±2	±1	±1	±1	±1	±1	±1	±1