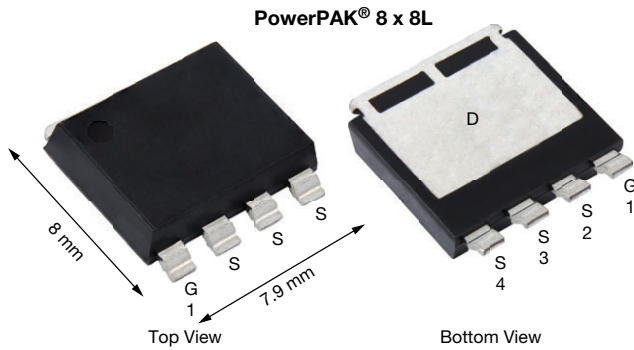

# Automotive N-Channel 40 V (D-S) 175 °C MOSFET

 AUTOMOTIVE  
GRADE

**RoHS**  
COMPLIANT  
HALOGEN  
**FREE**

## FEATURES

- TrenchFET® Gen IV power MOSFET
- AEC-Q101 qualified
- 100 % R<sub>G</sub> and UIS tested
- Thin 1.6 mm package
- Very low thermal resistance
- Material categorization:  
for definitions of compliance please see  
[www.vishay.com/doc?99912](http://www.vishay.com/doc?99912)

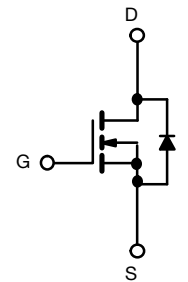

N-Channel MOSFET

## PRODUCT SUMMARY

V <sub>DS</sub> (V)	40
R <sub>DS(on)</sub> (Ω) at V <sub>GS</sub> = 10 V	0.0016
I <sub>D</sub> (A)	375
Configuration	Single
Package	PowerPAK 8 x 8L

## ABSOLUTE MAXIMUM RATINGS (T<sub>C</sub> = 25 °C, unless otherwise noted)

PARAMETER	SYMBOL	LIMIT	UNIT
Drain-source voltage	V <sub>DS</sub>	40	V
Gate-source voltage	V <sub>GS</sub>	± 20	
Continuous drain current	I <sub>D</sub>	T <sub>C</sub> = 25 °C	375
		T <sub>C</sub> = 125 °C	190
Continuous source current (diode conduction)	I <sub>S</sub>	195	A
Pulsed drain current <sup>b</sup>	I <sub>DM</sub>	750	
Single pulse avalanche current	I <sub>AS</sub>	35	mJ
Single pulse avalanche energy	E <sub>AS</sub>	61	
Maximum power dissipation	P <sub>D</sub>	T <sub>C</sub> = 25 °C	325
		T <sub>C</sub> = 125 °C	108
Operating junction and storage temperature range	T <sub>J</sub> , T <sub>stg</sub>	-55 to +175	°C
Soldering recommendations (peak temperature) <sup>d</sup>		260	

## THERMAL RESISTANCE RATINGS

PARAMETER	SYMBOL	LIMIT	UNIT
Junction-to-ambient	R <sub>thJA</sub>	44	°C/W
Junction-to-case (drain)	R <sub>thJC</sub>	0.38	

### Notes

- Package limited
- Pulse test; pulse width ≤ 300 μs, duty cycle ≤ 2 %
- When mounted on 1" square PCB (FR4 material)
- See solder profile ([www.vishay.com/doc?73257](http://www.vishay.com/doc?73257)). The end of the lead terminal is exposed copper (not plated) as a result of the singulation process in manufacturing. A solder fillet at the exposed copper tip cannot be guaranteed and is not required to ensure adequate bottom side solder interconnection



<b>SPECIFICATIONS</b> ( $T_C = 25\text{ }^\circ\text{C}$ , unless otherwise noted)							
PARAMETER	SYMBOL	TEST CONDITIONS		MIN.	TYP.	MAX.	UNIT
<b>Static</b>							
Drain-source breakdown voltage	$V_{DS}$	$V_{GS} = 0, I_D = 250\text{ }\mu\text{A}$		40	-	-	V
Gate-source threshold voltage	$V_{GS(th)}$	$V_{DS} = V_{GS}, I_D = 250\text{ }\mu\text{A}$		2	3	3.5	
Gate-source leakage	$I_{GSS}$	$V_{DS} = 0\text{ V}, V_{GS} = \pm 20\text{ V}$		-	-	$\pm 100$	nA
Zero gate voltage drain current	$I_{DSS}$	$V_{GS} = 0\text{ V}$	$V_{DS} = 40\text{ V}$	-	-	1	$\mu\text{A}$
		$V_{GS} = 0\text{ V}$	$V_{DS} = 40\text{ V}, T_J = 125\text{ }^\circ\text{C}$	-	-	200	
		$V_{GS} = 0\text{ V}$	$V_{DS} = 40\text{ V}, T_J = 175\text{ }^\circ\text{C}$	-	-	330	
On-state drain current <sup>a</sup>	$I_{D(on)}$	$V_{GS} = 10\text{ V}$	$V_{DS} \geq 5\text{ V}$	100	-	-	A
Drain-source on-state resistance <sup>a</sup>	$R_{DS(on)}$	$V_{GS} = 10\text{ V}$	$I_D = 20\text{ A}$	-	0.0013	0.0016	$\Omega$
		$V_{GS} = 10\text{ V}$	$I_D = 20\text{ A}, T_J = 125\text{ }^\circ\text{C}$	-	-	0.0024	
		$V_{GS} = 10\text{ V}$	$I_D = 20\text{ A}, T_J = 175\text{ }^\circ\text{C}$	-	-	0.0028	
Forward transconductance <sup>b</sup>	$g_{fs}$	$V_{DS} = 15\text{ V}, I_D = 60\text{ A}$		-	160	-	S
<b>Dynamic <sup>b</sup></b>							
Input capacitance	$C_{iss}$	$V_{GS} = 0\text{ V}$	$V_{DS} = 25\text{ V}, f = 1\text{ MHz}$	-	3950	4930	$\text{pF}$
Output capacitance	$C_{oss}$			-	1450	1810	
Reverse transfer capacitance	$C_{rss}$			-	77	100	
Total gate charge <sup>c</sup>	$Q_g$	$V_{GS} = 10\text{ V}$	$V_{DS} = 20\text{ V}, I_D = 30\text{ A}$	-	69	86	$\text{nC}$
Gate-source charge <sup>c</sup>	$Q_{gs}$			-	35	-	
Gate-drain charge <sup>c</sup>	$Q_{gd}$			-	24	-	
Gate resistance	$R_g$	$f = 1\text{ MHz}$		0.8	1.6	2.6	$\Omega$
Turn-on delay time <sup>c</sup>	$t_{d(on)}$	$V_{DD} = 20\text{ V}, R_L = 1\text{ }\Omega$ $I_D \approx 20\text{ A}, V_{GEN} = 10\text{ V}, R_g = 1\text{ }\Omega$		-	17	24	$\text{ns}$
Rise time <sup>c</sup>	$t_r$			-	41	57	
Turn-off delay time <sup>c</sup>	$t_{d(off)}$			-	32	44	
Fall time <sup>c</sup>	$t_f$			-	12	17	
<b>Source-Drain Diode Ratings and Characteristics <sup>b</sup></b>							
Reverse recovery time	$t_{rr}$	$V_{DD} = 32\text{ V}, I_{FM} = 15\text{ A},$ $di/dt = 100\text{ A}/\mu\text{s}$		-	45	-	ns
Reverse recovery charge	$Q_{rr}$			-	39	-	nC
Reverse recovery current	$I_{RM}$			-	-	2.1	A
Pulsed current <sup>a</sup>	$I_{SM}$			-	-	1600	A
Forward voltage	$V_{SD}$	$I_F = 50\text{ A}, V_{GS} = 0$		-	0.8	1.1	V

**Notes**

- a. Pulse test; pulse width  $\leq 300\text{ }\mu\text{s}$ , duty cycle  $\leq 2\text{ }\%$
- b. Guaranteed by design, not subject to production testing
- c. Independent of operating temperature

Stresses beyond those listed under "Absolute Maximum Ratings" may cause permanent damage to the device. These are stress ratings only, and functional operation of the device at these or any other conditions beyond those indicated in the operational sections of the specifications is not implied. Exposure to absolute maximum rating conditions for extended periods may affect device reliability.



TYPICAL CHARACTERISTICS (T<sub>A</sub> = 25 °C, unless otherwise noted)

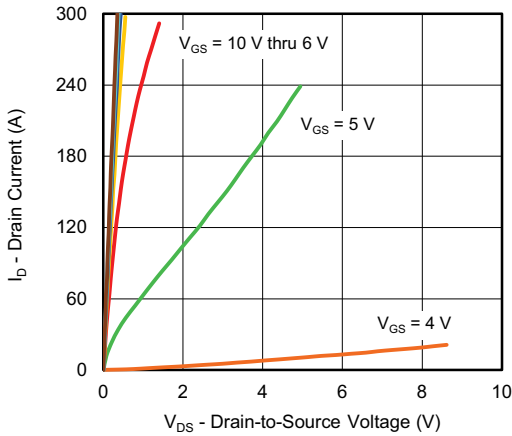

Output Characteristics

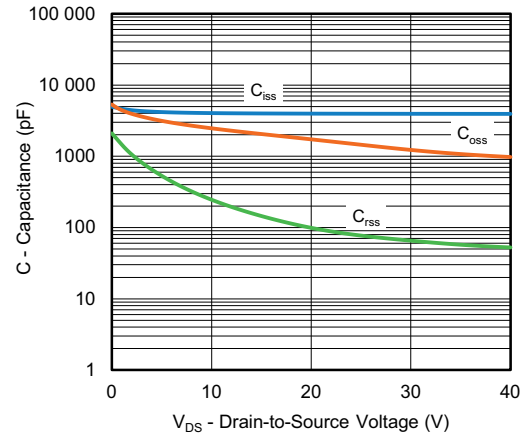

Capacitance

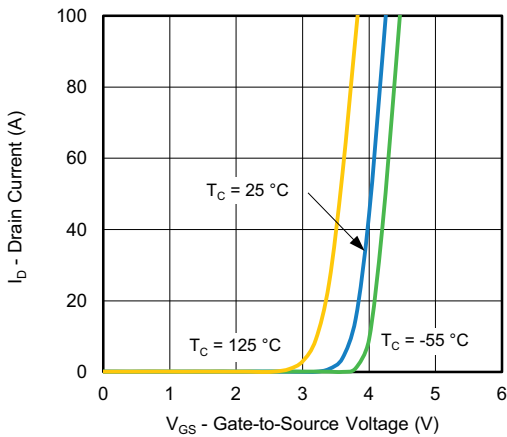

Transfer Characteristics

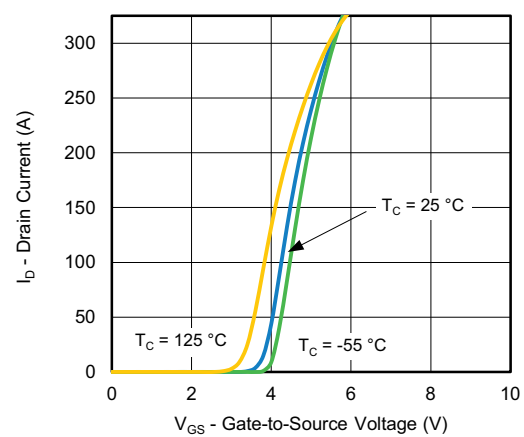

Transfer Characteristics

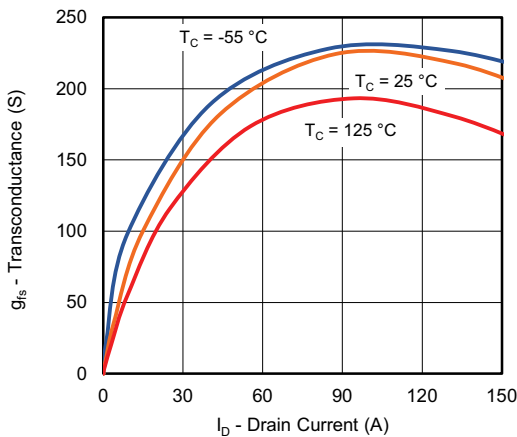

Transconductance

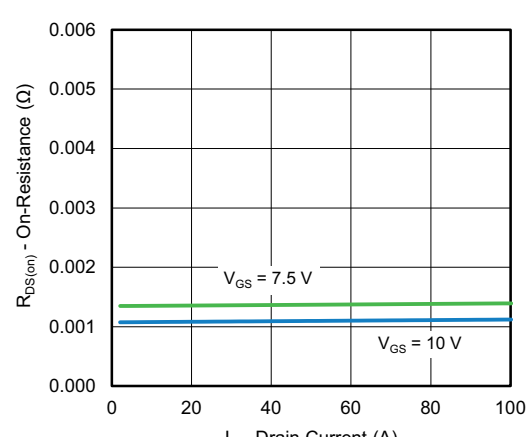

On-Resistance vs. Drain Current

**TYPICAL CHARACTERISTICS** ( $T_A = 25\text{ }^\circ\text{C}$ , unless otherwise noted)

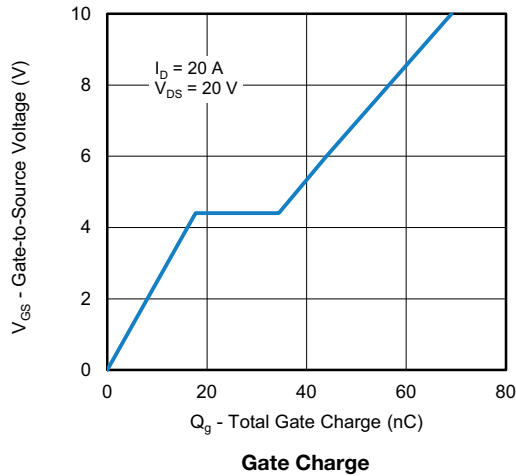

**Gate Charge**

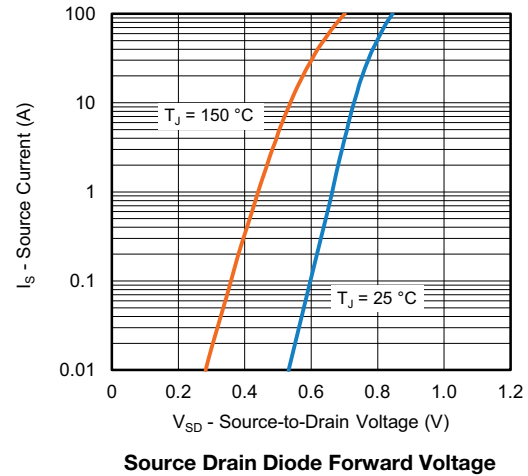

**Source Drain Diode Forward Voltage**

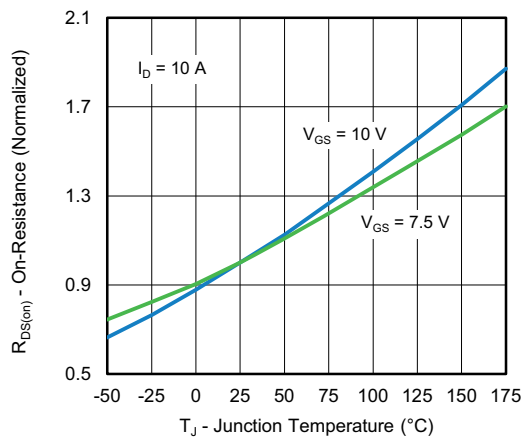

**On-Resistance vs. Junction Temperature**

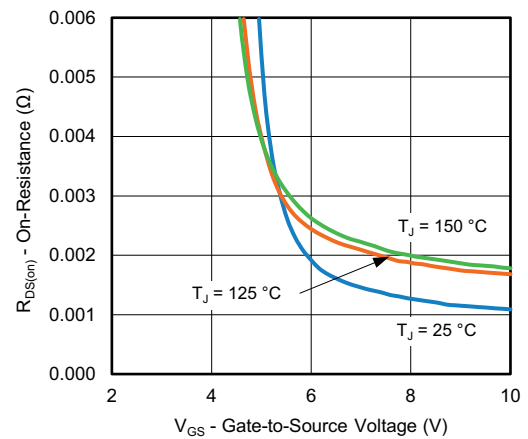

**On-Resistance vs. Gate-to-Source Voltage**

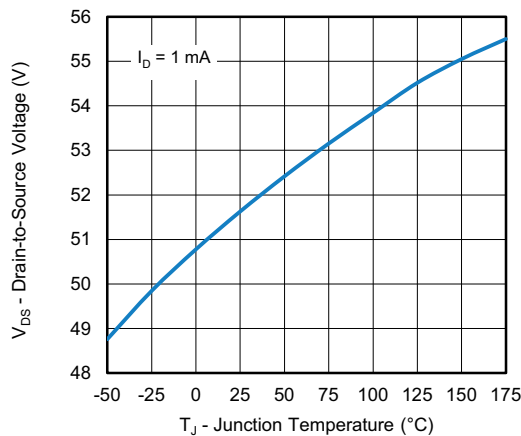

**Drain Source Breakdown vs. Junction Temperature**

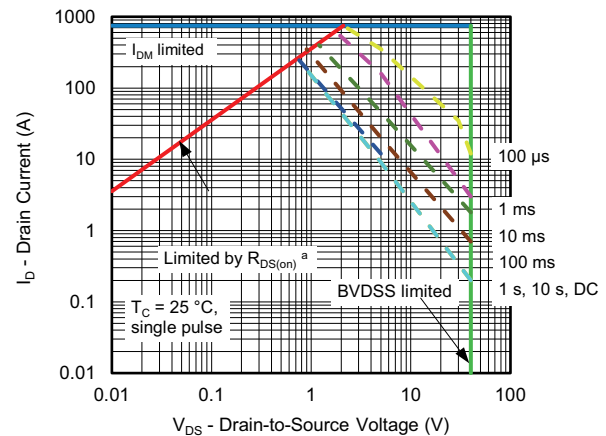

**Safe Operating Area**

**Note**

- a.  $V_{GS} >$  minimum  $V_{GS}$  at which  $R_{DS(on)}$  is specified



**THERMAL RATINGS** ( $T_A = 25\text{ }^\circ\text{C}$ , unless otherwise noted)

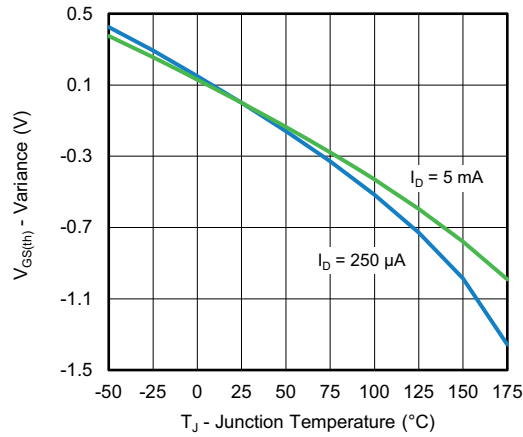

**Threshold Voltage**

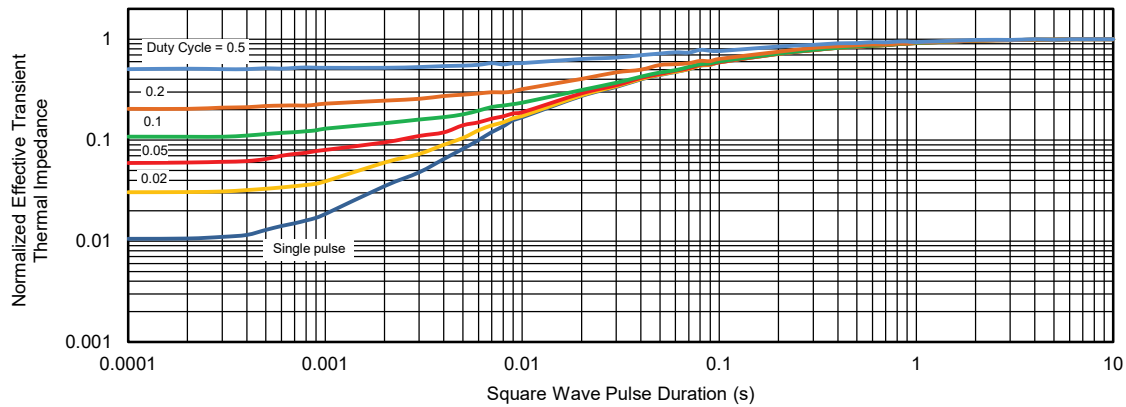

**Normalized Thermal Transient Impedance, Junction-to-Ambient**

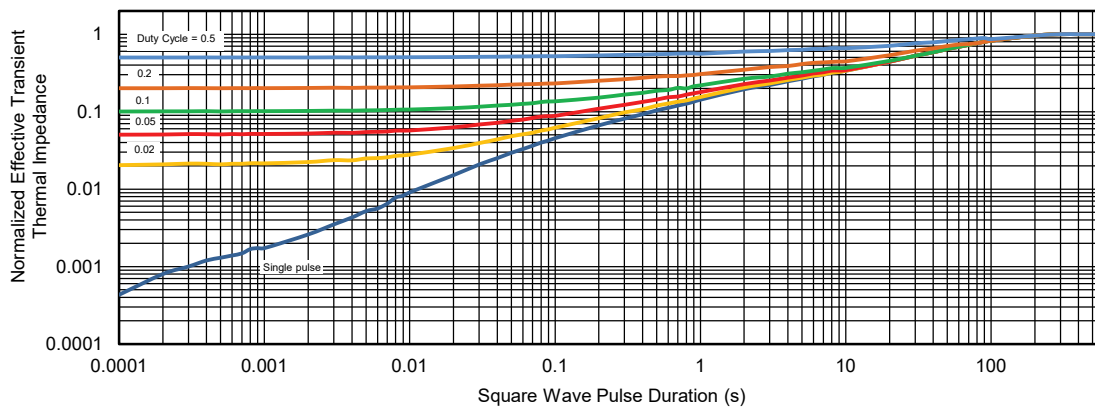

**Normalized Thermal Transient Impedance, Junction-to-Case**

Vishay Siliconix maintains worldwide manufacturing capability. Products may be manufactured at one of several qualified locations. Reliability data for Silicon Technology and Package Reliability represent a composite of all qualified locations. For related documents such as package / tape drawings, part marking, and reliability data, see [www.vishay.com/ppg?77269](http://www.vishay.com/ppg?77269).

## PowerPAK<sup>®</sup> 8 x 8L Case Outline

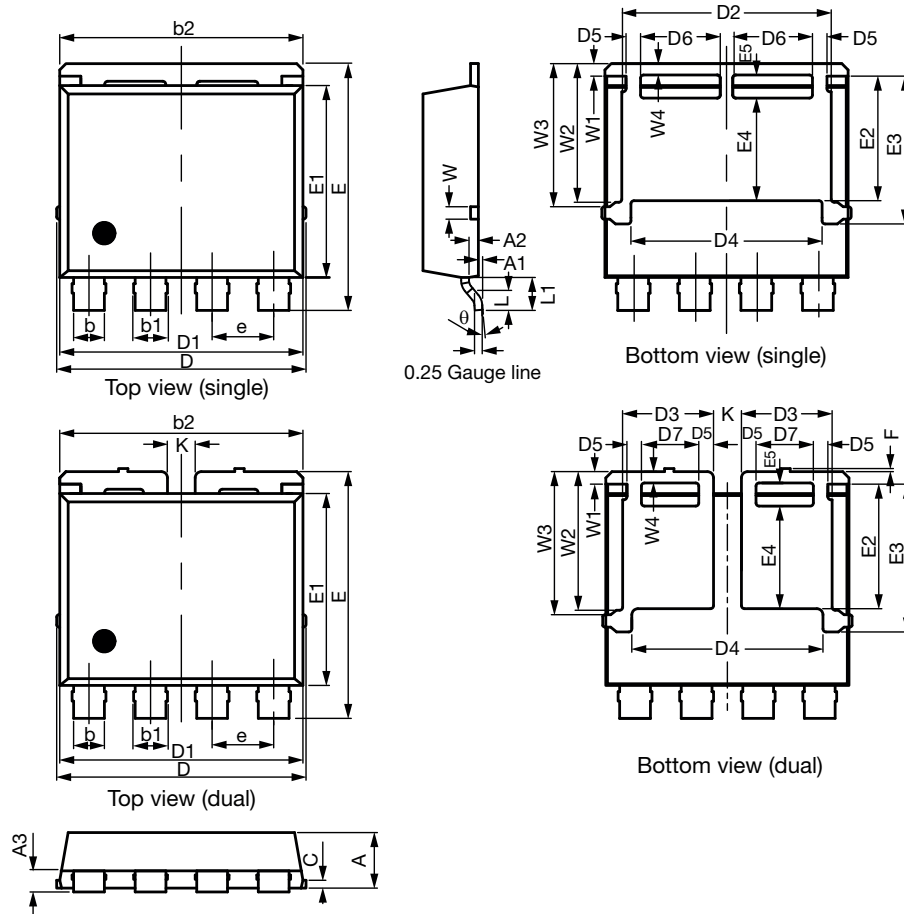

DIM.	MILLIMETERS			INCHES		
	MIN.	NOM.	MAX.	MIN.	NOM.	MAX.
A	1.70	1.80	1.90	0.067	0.071	0.075
A1	0.00	0.08	0.13	0.000	0.003	0.005
A2	0.25	0.30	0.35	0.010	0.012	0.014
A3	0.55	0.62	0.70	0.022	0.024	0.028
b	0.92	1.00	1.08	0.036	0.039	0.043
b1	1.02	1.10	1.18	0.040	0.043	0.046
b2	7.80	7.90	8.00	0.307	0.311	0.315
c	0.20	0.25	0.30	0.008	0.010	0.012
D	8.00	8.10	8.25	0.315	0.319	0.325
D1	7.80	7.90	8.00	0.307	0.311	0.315
D2	6.70	6.80	6.90	0.264	0.268	0.272
D3	2.85	2.95	3.05	0.112	0.116	0.120
D4	6.11	6.21	6.31	0.241	0.244	0.248
D5	0.37	0.47	0.57	0.015	0.019	0.022
D6	2.49	2.59	2.69	0.098	0.102	0.106
D7	1.76	1.86	1.96	0.069	0.073	0.077



DIM.	MILLIMETERS			INCHES		
	MIN.	NOM.	MAX.	MIN.	NOM.	MAX.
e	1.95	2.00	2.05	0.077	0.079	0.081
E	7.90	8.00	8.10	0.311	0.315	0.319
E1	6.12	6.22	6.32	0.241	0.245	0.249
E2	3.94	4.04	4.14	0.140	0.159	0.163
E3	4.69	4.79	4.89	0.185	0.189	0.193
E4	3.23	3.33	3.43	0.127	0.131	0.135
E5	0.65	0.75	0.85	0.026	0.030	0.033
F	0.00	0.10	0.15	0.000	0.004	0.006
L	0.62	0.72	0.82	0.024	0.028	0.032
L1	0.92	1.07	1.22	0.036	0.042	0.048
K	0.80	0.90	1.00	0.031	0.035	0.039
W	0.30	0.40	0.50	0.012	0.016	0.020
W1	0.30	0.40	0.50	0.012	0.016	0.020
W2	4.39	4.49	4.59	0.173	0.177	0.181
W3	4.54	4.64	4.74	0.179	0.183	0.187
W4	0.32	0.37	0.42	0.013	0.015	0.017
θ	6°	10°	14°	6°	10°	14°

C17-1388-Rev. B, 16-Oct-17  
DWG: 6026



## PowerPAK<sup>®</sup> 8 x 8L BWL Case Outline 2

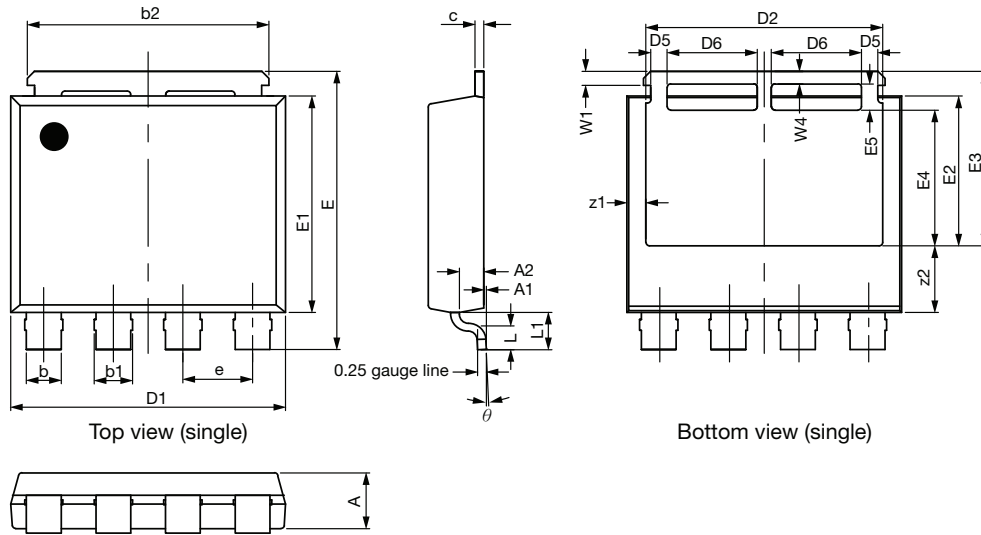

DIM.	MILLIMETERS			INCHES		
	MIN.	NOM.	MAX.	MIN.	NOM.	MAX.
A	1.50	1.60	1.70	0.059	0.063	0.067
A1	0.00	-	0.127	0.000	-	0.005
A2	0.655	0.705	0.755	0.026	0.028	0.030
b	0.92	1.00	1.08	0.036	0.039	0.043
b1	1.02	1.10	1.18	0.040	0.043	0.046
b2	6.84	6.94	7.04	0.269	0.273	0.277
c	0.20	0.25	0.30	0.008	0.010	0.012
D1	7.80	7.90	8.00	0.307	0.311	0.315
D2	6.70	6.80	6.90	0.264	0.268	0.272
D5	0.37	0.47	0.57	0.015	0.019	0.022
D6	2.49	2.59	2.69	0.098	0.102	0.106
e	1.97	2.00	2.03	0.078	0.079	0.080
E	7.90	8.00	8.10	0.311	0.315	0.319
E1	6.12	6.22	6.32	0.241	0.245	0.249
E2	4.21	4.31	4.41	0.166	0.170	0.174
E3	4.92	5.02	5.12	0.194	0.198	0.202
E4	3.80	3.90	4.00	0.150	0.154	0.157
E5	0.65	0.75	0.85	0.026	0.030	0.033
L	0.61	0.68	0.75	0.024	0.027	0.030
L1	1.00	1.07	1.15	0.039	0.042	0.045
W1	0.30	0.40	0.50	0.012	0.016	0.020
W4	0.32	0.37	0.42	0.013	0.015	0.017
z1	0.45	0.55	0.65	0.018	0.022	0.026
z2	1.81	1.91	2.01	0.071	0.075	0.079
θ	0°	-	5°	0°	-	5°

ECN: S19-0643-Rev. B, 05-Aug-2019  
DWG: 6073

**Note**

- Millimeter will govern







## Disclaimer

ALL PRODUCT, PRODUCT SPECIFICATIONS AND DATA ARE SUBJECT TO CHANGE WITHOUT NOTICE TO IMPROVE RELIABILITY, FUNCTION OR DESIGN OR OTHERWISE.

Vishay Intertechnology, Inc., its affiliates, agents, and employees, and all persons acting on its or their behalf (collectively, "Vishay"), disclaim any and all liability for any errors, inaccuracies or incompleteness contained in any datasheet or in any other disclosure relating to any product.

Vishay makes no warranty, representation or guarantee regarding the suitability of the products for any particular purpose or the continuing production of any product. To the maximum extent permitted by applicable law, Vishay disclaims (i) any and all liability arising out of the application or use of any product, (ii) any and all liability, including without limitation special, consequential or incidental damages, and (iii) any and all implied warranties, including warranties of fitness for particular purpose, non-infringement and merchantability.

Statements regarding the suitability of products for certain types of applications are based on Vishay's knowledge of typical requirements that are often placed on Vishay products in generic applications. Such statements are not binding statements about the suitability of products for a particular application. It is the customer's responsibility to validate that a particular product with the properties described in the product specification is suitable for use in a particular application. Parameters provided in datasheets and / or specifications may vary in different applications and performance may vary over time. All operating parameters, including typical parameters, must be validated for each customer application by the customer's technical experts. Product specifications do not expand or otherwise modify Vishay's terms and conditions of purchase, including but not limited to the warranty expressed therein.

Hyperlinks included in this datasheet may direct users to third-party websites. These links are provided as a convenience and for informational purposes only. Inclusion of these hyperlinks does not constitute an endorsement or an approval by Vishay of any of the products, services or opinions of the corporation, organization or individual associated with the third-party website. Vishay disclaims any and all liability and bears no responsibility for the accuracy, legality or content of the third-party website or for that of subsequent links.

Except as expressly indicated in writing, Vishay products are not designed for use in medical, life-saving, or life-sustaining applications or for any other application in which the failure of the Vishay product could result in personal injury or death. Customers using or selling Vishay products not expressly indicated for use in such applications do so at their own risk. Please contact authorized Vishay personnel to obtain written terms and conditions regarding products designed for such applications.

No license, express or implied, by estoppel or otherwise, to any intellectual property rights is granted by this document or by any conduct of Vishay. Product names and markings noted herein may be trademarks of their respective owners.