

P-Channel 60 V (D-S) MOSFET



FEATURES

- TrenchFET® power MOSFET
- Material categorization: for definitions of compliance please see www.vishay.com/doc?99912



RoHS
COMPLIANT
HALOGEN
FREE

APPLICATIONS

- Load switch

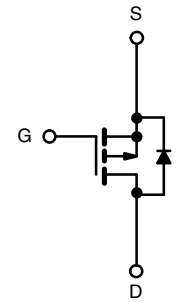

P-Channel MOSFET

PRODUCT SUMMARY

V_{DS} (V)	-60
$R_{DS(on)}$ max. (Ω) at $V_{GS} = -10$ V	0.015
$R_{DS(on)}$ max. (Ω) at $V_{GS} = -4.5$ V	0.020
I_D (A) ^d	-50
Configuration	Single

ORDERING INFORMATION

Package	TO-252
Lead (Pb)-free and halogen-free	SUD50P06-15-GE3
	SUD50P06-15-T4-GE3

ABSOLUTE MAXIMUM RATINGS ($T_A = 25$ °C, unless otherwise noted)

PARAMETER	SYMBOL	LIMIT	UNIT	
Drain-source voltage	V_{DS}	-60	V	
Gate-source voltage	V_{GS}	± 20		
Continuous drain current ($T_J = 175$ °C)	$T_C = 25$ °C	-50 ^d	A	
	$T_C = 125$ °C	-27.5		
Pulsed drain current	I_{DM}	-80		
Avalanche current	I_{AS}	-50	mJ	
Single pulse avalanche energy ^a	$L = 0.1$ mH	E_{AS}		125
Power dissipation	$T_C = 25$ °C	P_D	113 ^c	W
	$T_A = 25$ °C		2.5 ^{b, c}	
Operating junction and storage temperature range	T_J, T_{stg}	-55 to +150	°C	

THERMAL RESISTANCE RATINGS

PARAMETER	SYMBOL	TYPICAL	MAXIMUM	UNIT
Junction-to-ambient ^b	R_{thJA}	$t \leq 10$ s	15	°C/W
		Steady state	40	
Junction-to-case	R_{thJC}	0.82	1.1	

Notes

- Duty cycle $\leq 1\%$
- When mounted on 1" square PCB (FR4 material)
- See SOA curve for voltage derating
- Package limited



SPECIFICATIONS ($T_J = 25\text{ }^\circ\text{C}$, unless otherwise noted)						
PARAMETER	SYMBOL	TEST CONDITIONS	MIN.	TYP.	MAX.	UNIT
Static						
Drain-source breakdown voltage	V_{DS}	$V_{GS} = 0\text{ V}, I_D = -250\text{ }\mu\text{A}$	-60	-	-	V
Gate threshold voltage	$V_{GS(th)}$	$V_{DS} = V_{GS}, I_D = -250\text{ }\mu\text{A}$	-1	-	-3	
Gate-body leakage	I_{GSS}	$V_{DS} = 0\text{ V}, V_{GS} = \pm 20\text{ V}$	-	-	± 100	nA
Zero gate voltage drain current	I_{DSS}	$V_{DS} = -60\text{ V}, V_{GS} = 0\text{ V}$	-	-	-1	μA
		$V_{DS} = -60\text{ V}, V_{GS} = 0\text{ V}, T_J = 125\text{ }^\circ\text{C}$	-	-	-50	
		$V_{DS} = -60\text{ V}, V_{GS} = 0\text{ V}, T_J = 150\text{ }^\circ\text{C}$	-	-	-100	
On-state drain current ^a	$I_{D(on)}$	$V_{DS} = -5\text{ V}, V_{GS} = -10\text{ V}$	-50	-	-	A
Drain-source on-state resistance ^a	$R_{DS(on)}$	$V_{GS} = -10\text{ V}, I_D = -17\text{ A}$	-	0.012	0.015	Ω
		$V_{GS} = -10\text{ V}, I_D = -50\text{ A}, T_J = 125\text{ }^\circ\text{C}$	-	-	0.025	
		$V_{GS} = -10\text{ V}, I_D = -50\text{ A}, T_J = 150\text{ }^\circ\text{C}$	-	-	0.028	
		$V_{GS} = -4.5\text{ V}, I_D = -14\text{ A}$	-	-	0.020	
Forward transconductance ^a	g_{fs}	$V_{DS} = -15\text{ V}, I_D = -17\text{ A}$	-	61	-	S
Dynamic ^b						
Input capacitance	C_{iss}	$V_{GS} = 0\text{ V}, V_{DS} = -25\text{ V}, f = 1\text{ MHz}$	-	4950	-	pF
Output capacitance	C_{oss}		-	480	-	
Reverse transfer capacitance	C_{rss}		-	405	-	
Total gate charge ^c	Q_g	$V_{DS} = -30\text{ V}, V_{GS} = -10\text{ V}, I_D = -50\text{ A}$	-	110	165	nC
Gate-source charge ^c	Q_{gs}		-	19	-	
Gate-drain charge ^c	Q_{gd}		-	28	-	
Turn-on delay time ^c	$t_{d(on)}$	$V_{DD} = -30\text{ V}, R_L = 0.6\text{ }\Omega$ $I_D \cong -50\text{ A}, V_{GEN} = -10\text{ V}, R_G = 6\text{ }\Omega$	-	15	23	ns
Rise time ^c	t_r		-	70	105	
Turn-off delay time ^c	$t_{d(off)}$		-	175	260	
Fall time ^c	t_f		-	175	260	
Source-Drain Diode Ratings and Characteristics $T_C = 25\text{ }^\circ\text{C}$ ^b						
Continuous current	I_S		-	-	-50	A
Pulsed current	I_{SM}		-	-	-80	
Forward voltage ^a	V_{SD}	$I_F = -50\text{ A}, V_{GS} = 0\text{ V}$	-	-1	-1.6	V
Reverse recovery time	t_{rr}	$I_F = -50\text{ A}, di/dt = 100\text{ A}/\mu\text{s}$	-	45	70	ns

Notes

- Pulse test; pulse width $\leq 300\text{ }\mu\text{s}$, duty cycle $\leq 2\%$
- Guaranteed by design, not subject to production testing
- Independent of operating temperature

Stresses beyond those listed under "Absolute Maximum Ratings" may cause permanent damage to the device. These are stress ratings only, and functional operation of the device at these or any other conditions beyond those indicated in the operational sections of the specifications is not implied. Exposure to absolute maximum rating conditions for extended periods may affect device reliability.

TYPICAL CHARACTERISTICS (25 °C, unless otherwise noted)

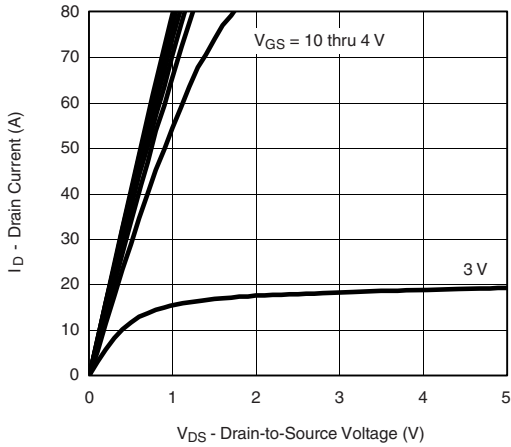

Output Characteristics

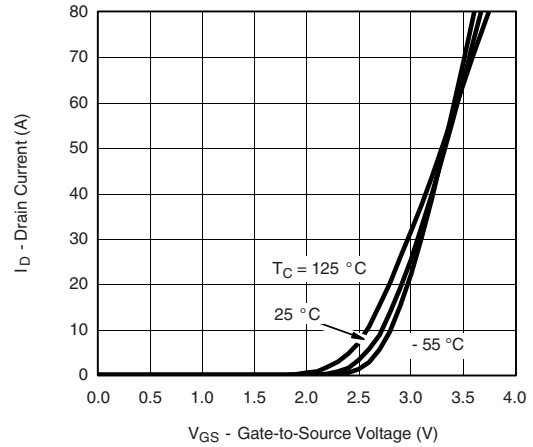

Transfer Characteristics

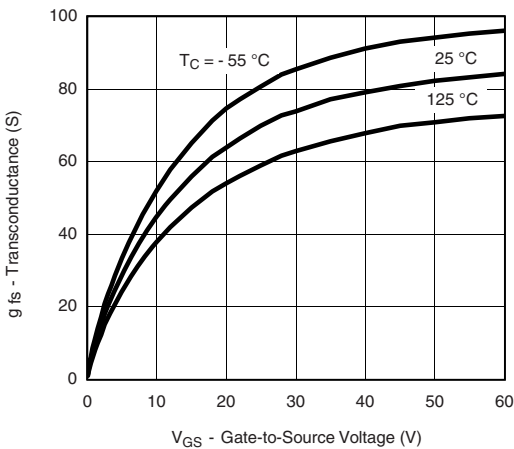

Transconductance

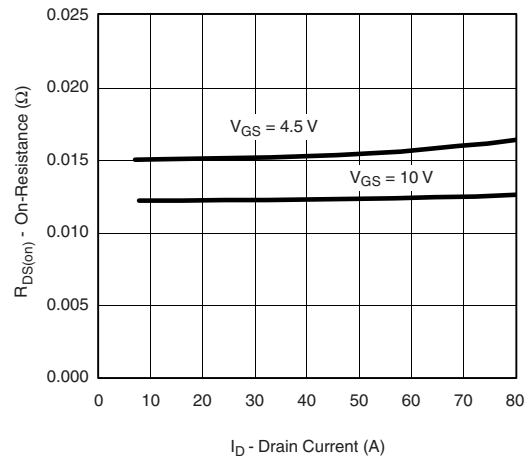

On-Resistance vs. Drain Current

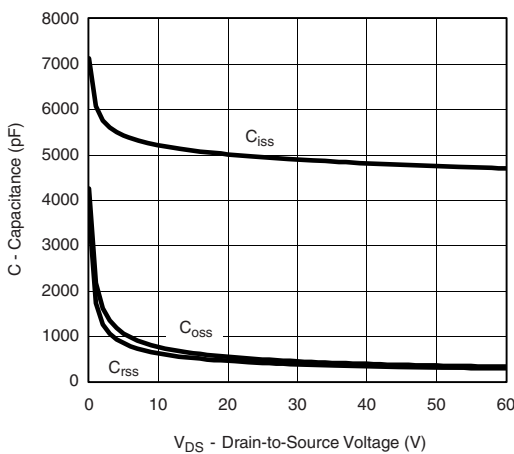

Capacitance

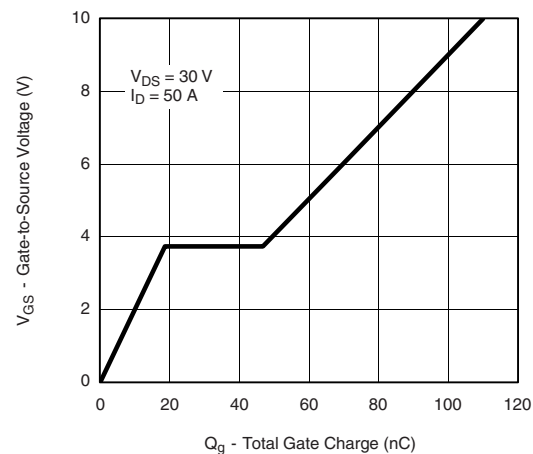

Gate Charge



TYPICAL CHARACTERISTICS

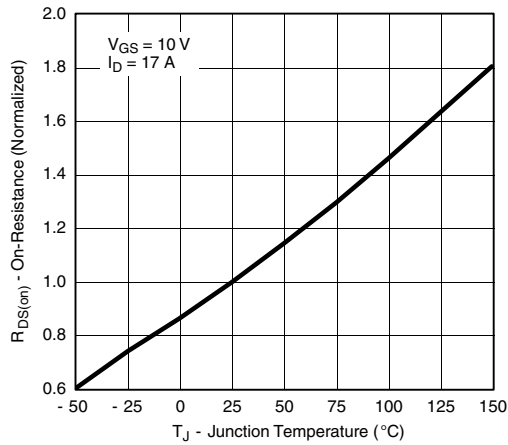

On-Resistance vs. Junction Temperature

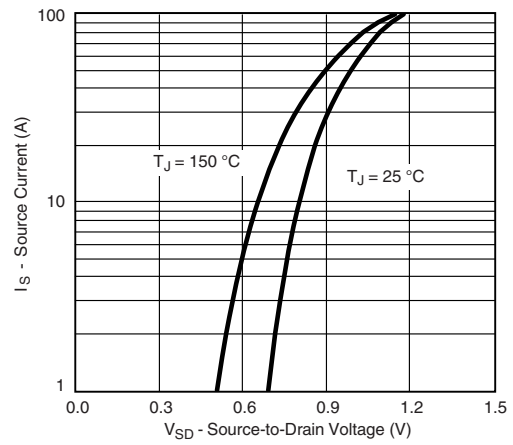

Source-Drain Diode Forward Voltage

THERMAL RATINGS (25 °C, unless otherwise noted)

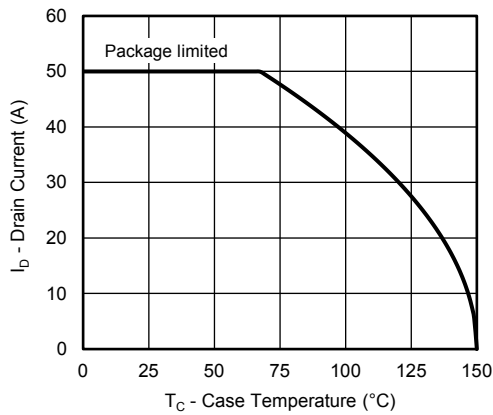

Drain Current vs. Case Temperature

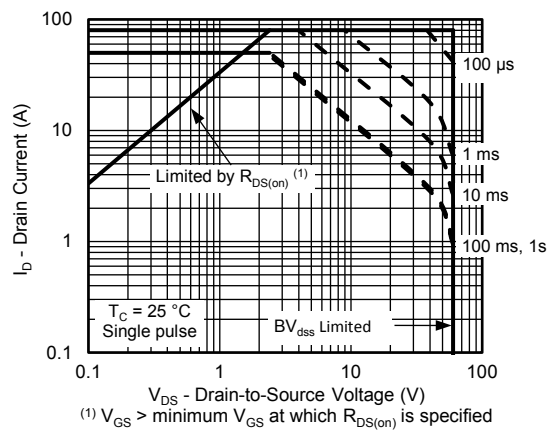

Safe Operating Area

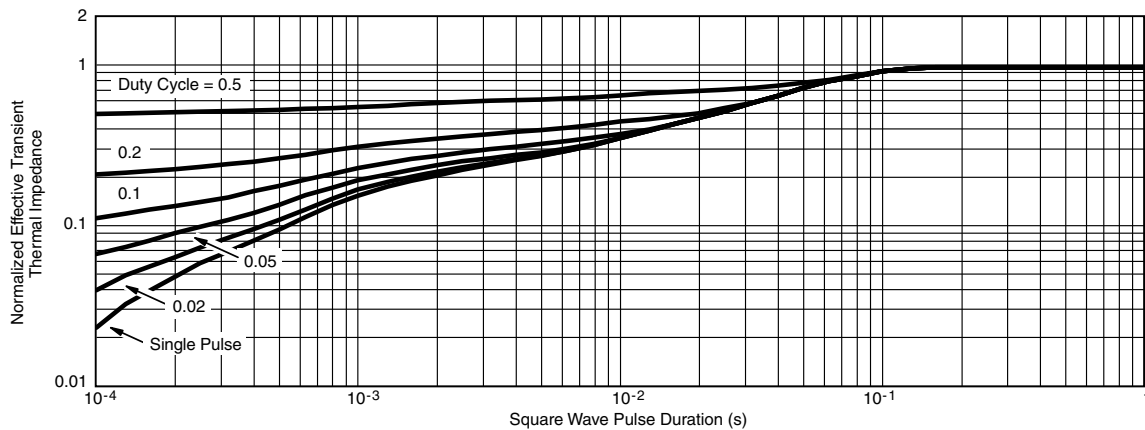

Normalized Thermal Transient Impedance, Junction-to-Case

Vishay Siliconix maintains worldwide manufacturing capability. Products may be manufactured at one of several qualified locations. Reliability data for silicon technology and package reliability represent a composite of all qualified locations. For related documents such as package / tape drawings, part marking, and reliability data, see www.vishay.com/ppg?68940.



TO-252AA Case Outline

VERSION 1: FACILITY CODE = Y



MILLIMETERS		
DIM.	MIN.	MAX.
A	2.18	2.38
A1	-	0.127
b	0.64	0.88
b2	0.76	1.14
b3	4.95	5.46
C	0.46	0.61
C2	0.46	0.89
D	5.97	6.22
D1	4.10	-
E	6.35	6.73
E1	4.32	-
H	9.40	10.41
e	2.28 BSC	
e1	4.56 BSC	
L	1.40	1.78
L3	0.89	1.27
L4	-	1.02
L5	1.01	1.52

Note

- Dimension L3 is for reference only



VERSION 2: FACILITY CODE = N

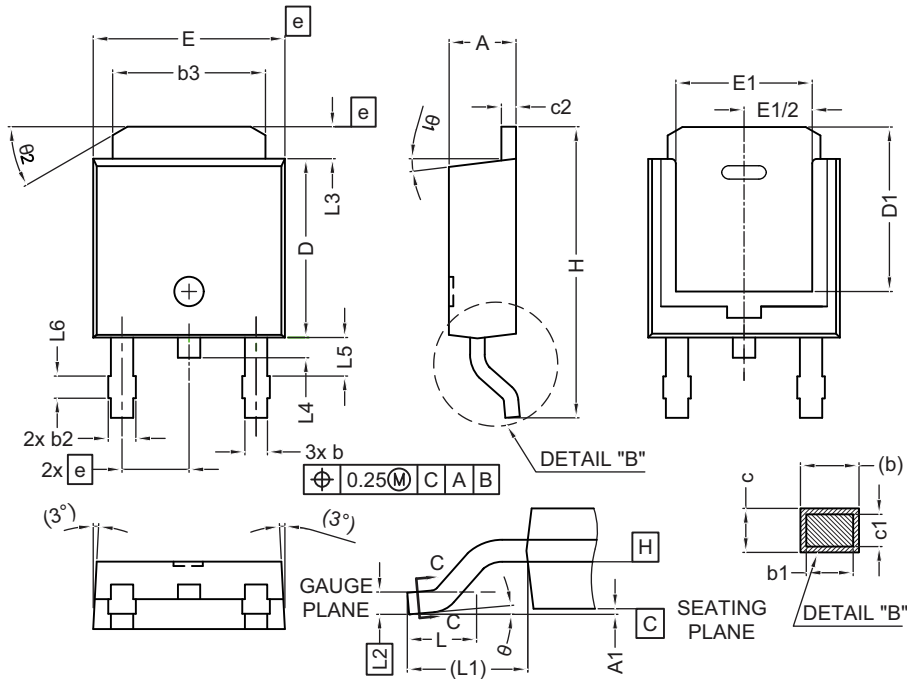

MILLIMETERS		
DIM.	MIN.	MAX.
A	2.18	2.39
A1	-	0.13
b	0.65	0.89
b1	0.64	0.79
b2	0.76	1.13
b3	4.95	5.46
c	0.46	0.61
c1	0.41	0.56
c2	0.46	0.60
D	5.97	6.22
D1	5.21	-
E	6.35	6.73
E1	4.32	-
e	2.29 BSC	
H	9.94	10.34

MILLIMETERS		
DIM.	MIN.	MAX.
L	1.50	1.78
L1	2.74 ref.	
L2	0.51 BSC	
L3	0.89	1.27
L4	-	1.02
L5	1.14	1.49
L6	0.65	0.85
θ	0°	10°
θ1	0°	15°
θ2	25°	35°

Notes

- Dimensioning and tolerance confirm to ASME Y14.5M-1994
- All dimensions are in millimeters. Angles are in degrees
- Heat sink side flash is max. 0.8 mm
- Radius on terminal is optional

ECN: E19-0649-Rev. Q, 16-Dec-2019
 DWG: 5347

RECOMMENDED MINIMUM PADS FOR DPAK (TO-252)



Recommended Minimum Pads
Dimensions in Inches/(mm)

[Return to Index](#)



Disclaimer

ALL PRODUCT, PRODUCT SPECIFICATIONS AND DATA ARE SUBJECT TO CHANGE WITHOUT NOTICE TO IMPROVE RELIABILITY, FUNCTION OR DESIGN OR OTHERWISE.

Vishay Intertechnology, Inc., its affiliates, agents, and employees, and all persons acting on its or their behalf (collectively, "Vishay"), disclaim any and all liability for any errors, inaccuracies or incompleteness contained in any datasheet or in any other disclosure relating to any product.

Vishay makes no warranty, representation or guarantee regarding the suitability of the products for any particular purpose or the continuing production of any product. To the maximum extent permitted by applicable law, Vishay disclaims (i) any and all liability arising out of the application or use of any product, (ii) any and all liability, including without limitation special, consequential or incidental damages, and (iii) any and all implied warranties, including warranties of fitness for particular purpose, non-infringement and merchantability.

Statements regarding the suitability of products for certain types of applications are based on Vishay's knowledge of typical requirements that are often placed on Vishay products in generic applications. Such statements are not binding statements about the suitability of products for a particular application. It is the customer's responsibility to validate that a particular product with the properties described in the product specification is suitable for use in a particular application. Parameters provided in datasheets and / or specifications may vary in different applications and performance may vary over time. All operating parameters, including typical parameters, must be validated for each customer application by the customer's technical experts. Product specifications do not expand or otherwise modify Vishay's terms and conditions of purchase, including but not limited to the warranty expressed therein.

Hyperlinks included in this datasheet may direct users to third-party websites. These links are provided as a convenience and for informational purposes only. Inclusion of these hyperlinks does not constitute an endorsement or an approval by Vishay of any of the products, services or opinions of the corporation, organization or individual associated with the third-party website. Vishay disclaims any and all liability and bears no responsibility for the accuracy, legality or content of the third-party website or for that of subsequent links.

Except as expressly indicated in writing, Vishay products are not designed for use in medical, life-saving, or life-sustaining applications or for any other application in which the failure of the Vishay product could result in personal injury or death. Customers using or selling Vishay products not expressly indicated for use in such applications do so at their own risk. Please contact authorized Vishay personnel to obtain written terms and conditions regarding products designed for such applications.

No license, express or implied, by estoppel or otherwise, to any intellectual property rights is granted by this document or by any conduct of Vishay. Product names and markings noted herein may be trademarks of their respective owners.