

N-Channel MOSFET

Features

- $V_{DS} = 20\text{ V}$, $I_D = 0.75\text{ A}$
 $R_{DS(on)} < 0.38\Omega @ V_{GS} = 4.5\text{ V}$
 $R_{DS(on)} < 0.45\Omega @ V_{GS} = 2.5\text{ V}$
- Trench MOSFET Technology
- Low Threshold Voltage
- Pb Free Device
- ESD Protected

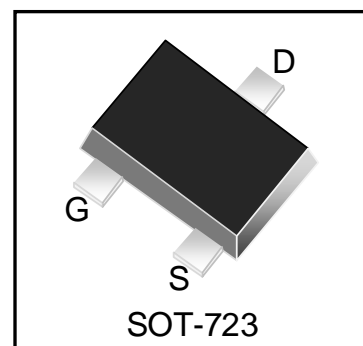

Mechanical Characteristics

- SOT-723 Package
- Marking : Making Code
- RoHS Compliant

Schematic & PIN Configuration

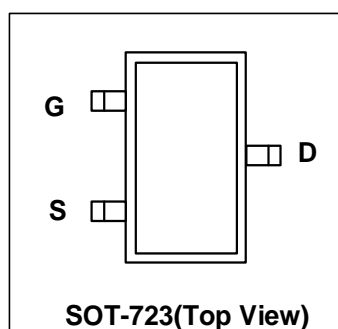
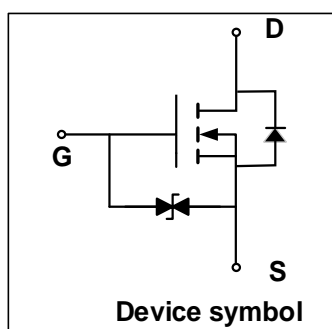

Absolute Maximum Rating

Parameter	Symbol	Value	Unit
Drain-Source Voltage	V_{DS}	20	V
Gate-Source Voltage	V_{GS}	± 10	V
Continuous Drain Current	I_D	0.75	A
Pulsed Drain Current ¹	I_{DM}	1.8	A
Power Dissipation	P_D	150	mW
Junction Temperature	T_J	150	$^{\circ}\text{C}$
Storage Temperature	T_{STG}	-55 to +150	$^{\circ}\text{C}$
Thermal Resistance from Junction to Ambient ²	$R_{\theta JA}$	833	$^{\circ}\text{C/W}$

Electrical Characteristics ($T_{amb}=25^{\circ}\text{C}$ unless otherwise noted)

Parameter	Symbol	Test Condition	Min.	Typ.	Max.	Unit
Static Characteristics						
Drain-Source Breakdown Voltage	BV_{DSS}	$V_{GS} = 0\text{ V}, I_D = 250\mu\text{A}$	20	-	-	V
Zero Gate Voltage Drain Current	I_{DSS}	$V_{DS} = 20\text{ V}, V_{GS} = 0\text{ V}$	-	-	1	μA
Gate-body Leakage Current	I_{GSS}	$V_{DS} = 0\text{ V}, V_{GS} = \pm 10\text{ V}$	-	-	± 20	μA
Gate Threshold Voltage ³	$V_{GS(th)}$	$V_{DS} = V_{GS}, I_D = 250\mu\text{A}$	0.35	0.75	1.1	V
Drain-Source On-state Resistance ³	$R_{DS(on)}$	$V_{GS} = 4.5\text{ V}, I_D = 0.65\text{ A}$	-	0.19	0.38	Ω
		$V_{GS} = 2.5\text{ V}, I_D = 0.55\text{ A}$	-	0.26	0.45	
		$V_{GS} = 1.8\text{ V}, I_D = 0.45\text{ A}$	-	0.35	-	
Dynamic Characteristics						
Input Capacitance	C_{iss}	$V_{GS} = 0\text{ V}, V_{DS} = 16\text{ V},$ $f = 1\text{ MHz}$	-	54		pF
Output Capacitance	C_{oss}		-	10		
Reverse Transfer Capacitance	C_{rss}		-	7.5		
Switching Characteristics						
Turn-on Delay Time ⁴	$t_{d(on)}$	$V_{DS} = 10\text{ V}, V_{GS} = 4.5\text{ V},$ $I_D = 0.5\text{ A}, R_{GEN} = 10\Omega$	-	6.7	-	nS
Rise Time ⁴	t_r			4.8	-	
Turn-off Delay Time ⁴	$t_{d(off)}$		-	17.3	-	
Fall Time ⁴	t_f		-	7.4	-	
Source-Drain Diode Characteristics						
Body Diode Voltage	V_{SD}	$I_S = 0.15\text{ A}, V_{GS} = 0\text{ V}$	-	-	1.2	V

Notes:

1. Repetitive Rating: Pulse width limited by maximum junction temperature.
2. Surface mounted on FR4 board using 1 square inch pad size, 1oz single-side copper.
3. Pulse Test: Pulse width $\leq 300\mu\text{s}$, duty cycle $\leq 2\%$.
4. Guaranteed by design, not subject to product

Typical Characteristics

Figure 1. Output Characteristics

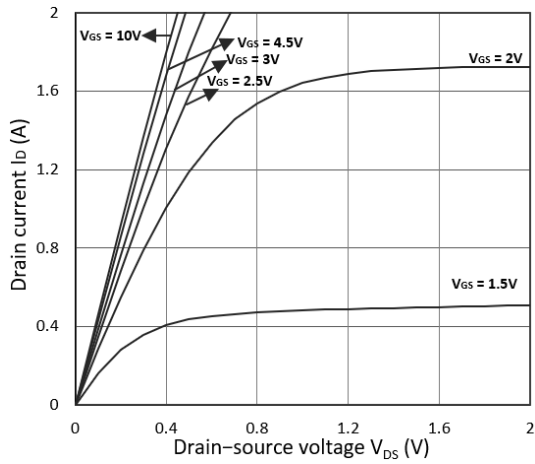

Figure 2. Transfer Characteristics

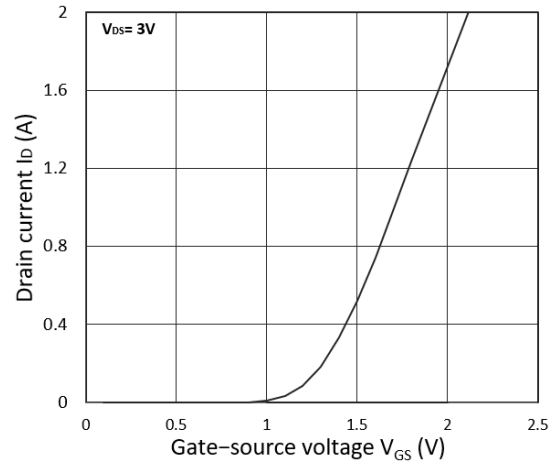

Figure 3. $R_{DS(ON)}$ vs. I_D

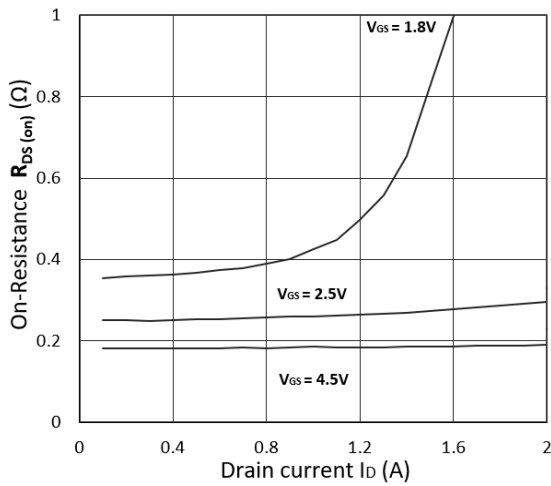

Figure 4. $R_{DS(ON)}$ vs. V_{GS}

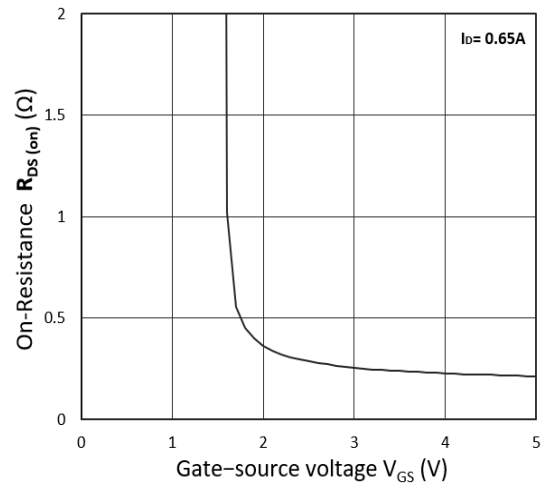

Figure 5. I_S vs. V_{SD}

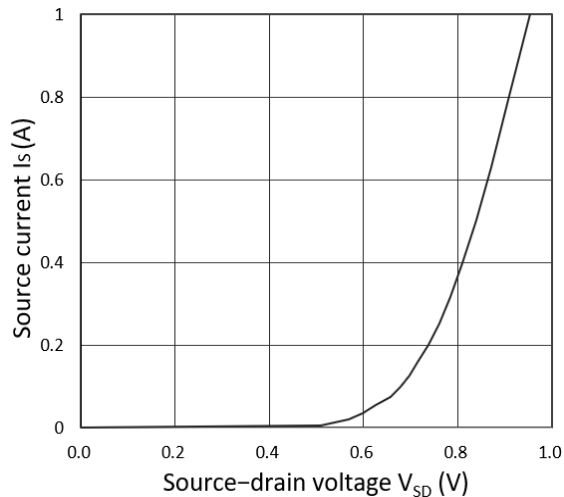
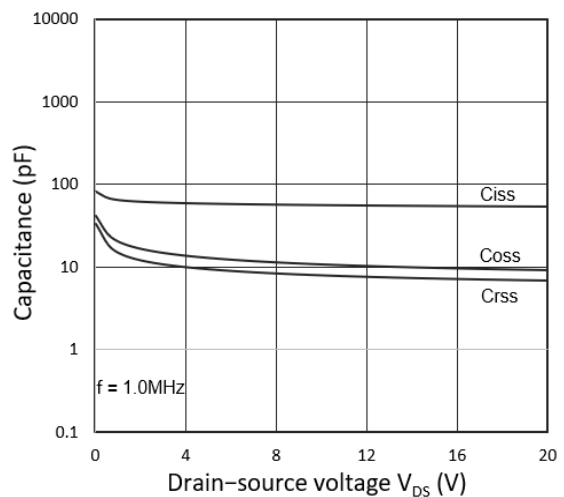

Figure 6. Capacitance Characteristics



Outline Drawing – SOT-723

PACKAGE OUTLINE

SYMBOL	MILLIMETER		INCHES	
	MIN	MAX	MIN	MAX
A	0.430	0.500	0.017	0.020
b	0.170	0.270	0.007	0.011
b1	0.270	0.370	0.011	0.015
C	0.080	0.150	0.003	0.006
D	1.150	1.250	0.045	0.049
E	1.150	1.250	0.045	0.049
E1	0.750	0.850	0.030	0.033
e	0.400BSC		0.016 BSC	
θ	7°REF		7°REF	

DIMENSIONS		
DIM	INCHES	MILLIMETERS
C	0.0118	0.30
M	0.0390	1.00
e	0.0157	0.40
e1	0.0314	0.80
b	0.0165	0.42

Notes

1. Dimensioning and tolerances per ANSI Y14.5M, 1985.
2. Controlling Dimension: Millimeters.

Marking Codes

Part Number	WM02N08H
Marking Code	

Package Information

Qty: 8k/Reel

CONTACT INFORMATION

No.1001, Shiwan (7) Road, Pudong District, Shanghai, P.R.China.201207

Tel: 86-21-68969993 Fax: 86-21-50757680 Email: market@way-on.com

WAYON website: <http://www.way-on.com>

For additional information, please contact your local Sales Representative.

WAYON ® is registered trademark of Wayon Corporation.

Specifications are subject to change without notice.
The device characteristics and parameters in this data sheet can and do vary in different applications and actual device performance may vary over time.
Users should verify actual device performance in their specific applications.