

**600V 0.83Ω Super Junction Power MOSFET**

**Description**

WMOS™ C2 is Wayon's 2<sup>nd</sup> generation super junction MOSFET family that is utilizing charge balance technology for extremely low on-resistance and low gate charge performance. WMOS™ C2 is suitable for applications which require superior power density and outstanding efficiency.

**Features**

- $V_{DS} = 650V @ T_{j,max}$
- Typ.  $R_{DS(on)} = 0.83\Omega$
- 100% UIS tested
- Pb-free plating, Halogen free

**Applications**

LED Lighting, Charger, Adapter, PC, LCD TV, Server

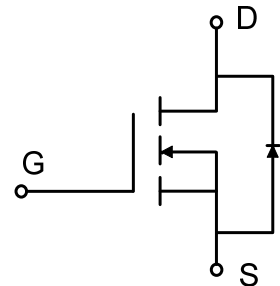

**Absolute Maximum Ratings**

Parameter	Symbol	WMF09N60C2	Unit
Drain-source voltage	$V_{DSS}$	600	V
Continuous drain current <sup>1)</sup> ( $T_C = 25^\circ C$ )	$I_D$	6	A
		( $T_C = 100^\circ C$ )	3.6
Pulsed drain current <sup>2)</sup>	$I_{DM}$	12	A
Gate-source voltage	$V_{GS}$	$\pm 30$	V
Avalanche energy, single pulse <sup>3)</sup>	$E_{AS}$	26	mJ
Avalanche energy, repetitive <sup>2)</sup>	$E_{AR}$	0.1	mJ
Avalanche current, repetitive <sup>2)</sup>	$I_{AR}$	0.9	A
Power dissipation ( $T_C = 25^\circ C$ )	$P_D$	6	W
		- Derate above $25^\circ C$	0.05
Operating and storage temperature range	$T_{j}, T_{stg}$	-55 to +150	$^\circ C$
Continuous diode forward current	$I_S$	6	A
Diode pulse current	$I_{S,pulse}$	12	A

**Thermal Characteristics**

Parameter	Symbol	WMF09N60C2	Unit
Thermal resistance, junction-to-case	$R_{\theta JC}$	21	$^\circ C/W$
Thermal resistance, junction-to-ambient	$R_{\theta JA}$	75	$^\circ C/W$

**Electrical Characteristics**  $T_c = 25^\circ\text{C}$ , unless otherwise noted

Parameter	Symbol	Test Condition	Min.	Typ.	Max.	Unit
<b>Static characteristics</b>						
Drain-source breakdown voltage	$BV_{DSS}$	$V_{GS}=0\text{ V}, I_D=0.25\text{ mA}$	600	-	-	V
Gate threshold voltage	$V_{GS(th)}$	$V_{DS}=V_{GS}, I_D=0.25\text{ mA}$	2.5	3.3	4.5	V
Drain cut-off current	$I_{DSS}$	$V_{DS}=600\text{ V}, V_{GS}=0\text{ V},$ $T_j = 25^\circ\text{C}$ $T_j = 125^\circ\text{C}$	-	-	1	$\mu\text{A}$
Gate leakage current, forward	$I_{GSSF}$	$V_{GS}=30\text{ V}, V_{DS}=0\text{ V}$	-	-	100	nA
Gate leakage current, reverse	$I_{GSSR}$	$V_{GS}=-30\text{ V}, V_{DS}=0\text{ V}$	-	-	-100	nA
Drain-source on-state resistance	$R_{DS(on)}$	$V_{GS}=10\text{ V}, I_D=1\text{ A}$ $T_j = 25^\circ\text{C}$	-	0.83	0.98	$\Omega$
<b>Dynamic characteristics</b>						
Input capacitance	$C_{iss}$	$V_{DS}=25\text{ V}, V_{GS}=0\text{ V},$	-	302	-	pF
Output capacitance	$C_{oss}$	$f = 1\text{ MHz}$	-	221	-	
Reverse transfer capacitance	$C_{rss}$		-	2.1	-	
Turn-on delay time	$t_{d(on)}$	$V_{DD} = 300\text{V}, I_D = 2\text{A}$	-	8	-	ns
Rise time	$t_r$	$R_G = 25\Omega, V_{GS}=10\text{V}$	-	17	-	
Turn-off delay time	$t_{d(off)}$		-	27	-	
Fall time	$t_f$		-	13	-	
<b>Gate charge characteristics</b>						
Gate to source charge	$Q_{gs}$	$V_{DD}=480\text{ V}, I_D=2\text{A},$	-	1.8	-	nC
Gate to drain charge	$Q_{gd}$	$V_{GS}=0\text{ to }10\text{ V}$	-	2	-	
Gate charge total	$Q_g$		-	6.8	-	
Gate plateau voltage	$V_{plateau}$		-	5.4	-	V
<b>Reverse diode characteristics</b>						
Diode forward voltage	$V_{SD}$	$V_{GS}=0\text{ V}, I_F=2\text{A}$	-	-	1.2	V
Reverse recovery time	$t_{rr}$	$V_R=50\text{ V}, I_F=2\text{A},$	-	166	-	ns
Reverse recovery charge	$Q_{rr}$	$dI_F/dt=100\text{ A}/\mu\text{s}$	-	0.91	-	$\mu\text{C}$
Peak reverse recovery current	$I_{rrm}$		-	11.4	-	A

## Notes:

- Limited by  $T_{j\max}$ . Maximum duty cycle  $D=0.5$ .
- Repetitive rating: pulse width limited by maximum junction temperature.
- $I_{AS} = 0.9\text{A}$ ,  $V_{DD} = 50\text{V}$ ,  $R_G = 25\Omega$ , starting  $T_j = 25^\circ\text{C}$ .

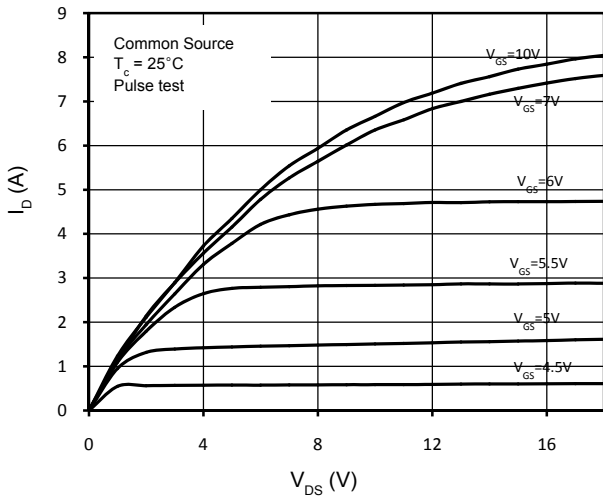

Figure 1. On-Region Characteristics

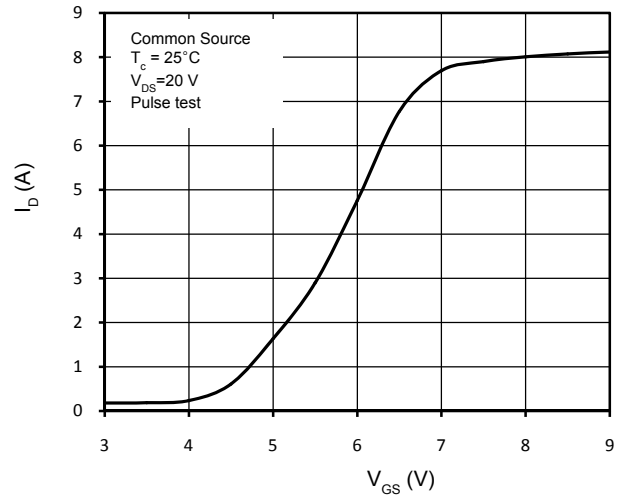

Figure 2. Transfer Characteristics

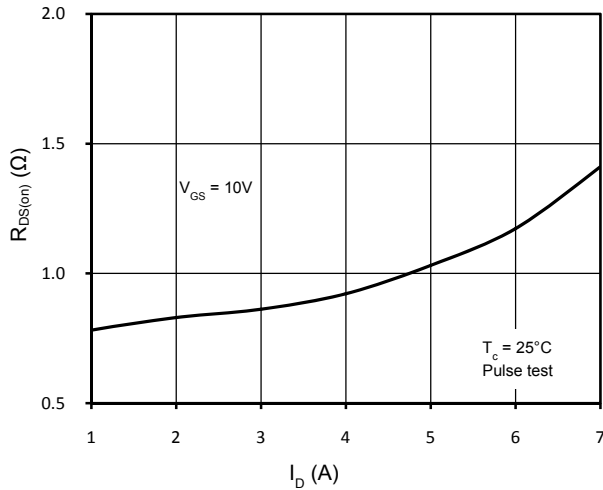

Figure 3. Static Drain-Source On Resistance

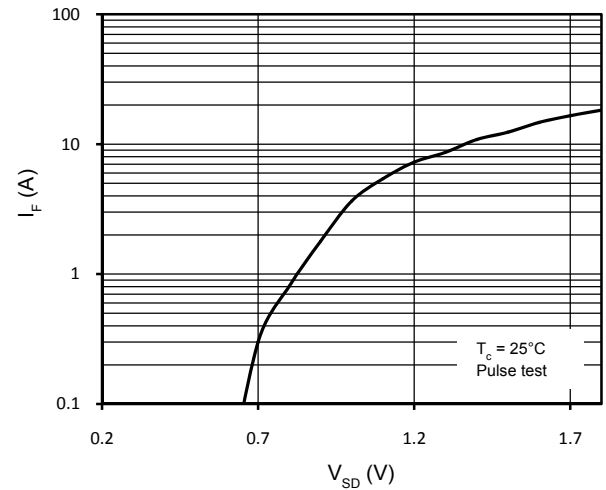

Figure 4. Body-Diode Forward Characteristics

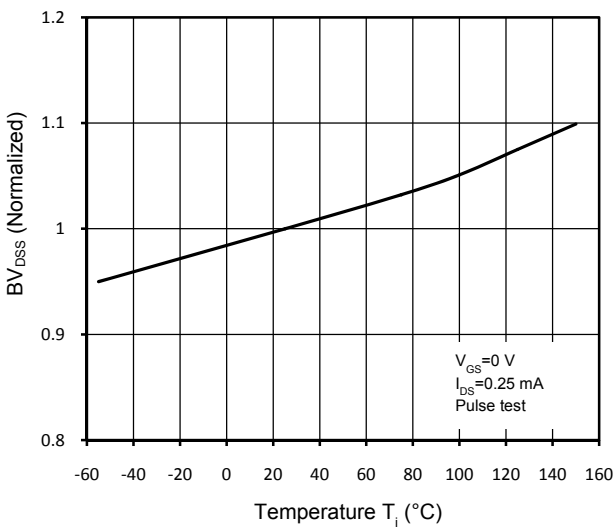

Figure 5. Normalized  $BV_{DS}$  vs. Temperature

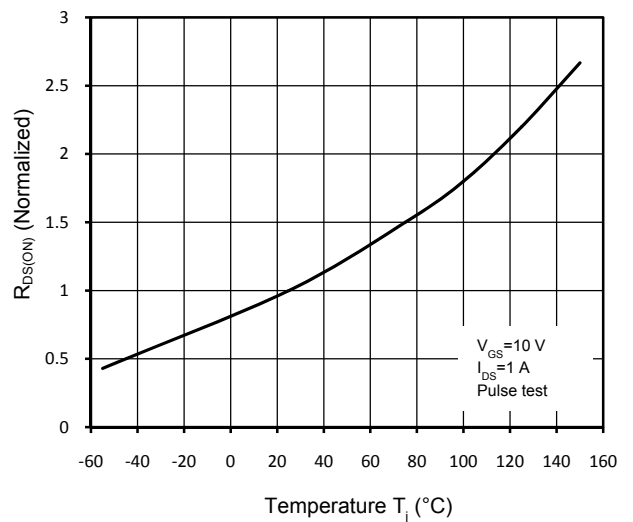

Figure 6. Normalized  $R_{DS(on)}$  vs. Temperature

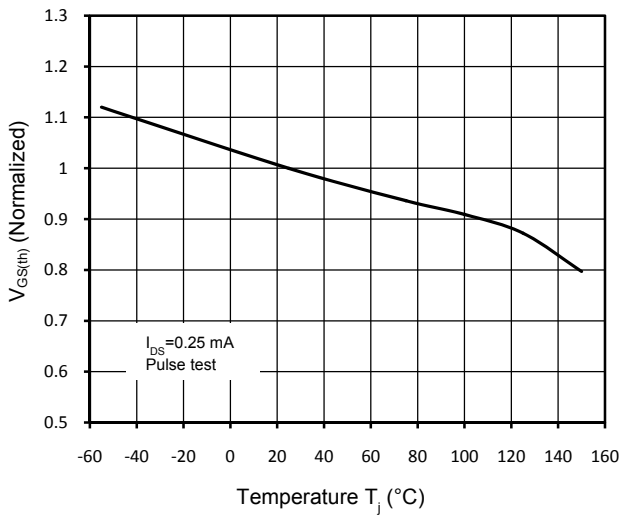

Figure 7. Threshold Voltage vs. Temperature

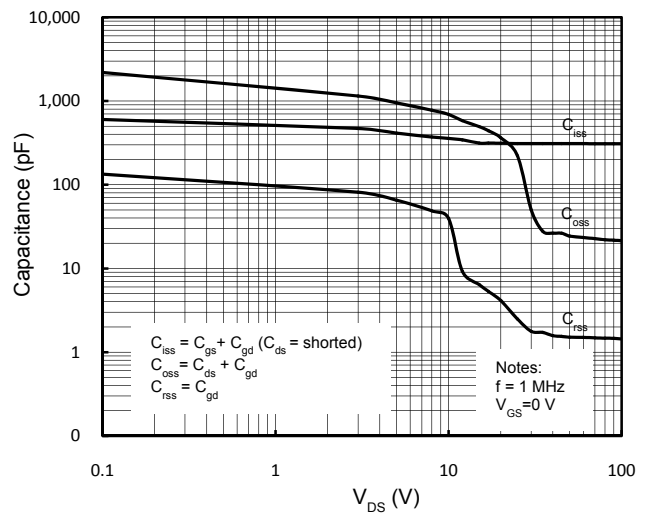

Figure 8. Capacitance Characteristics

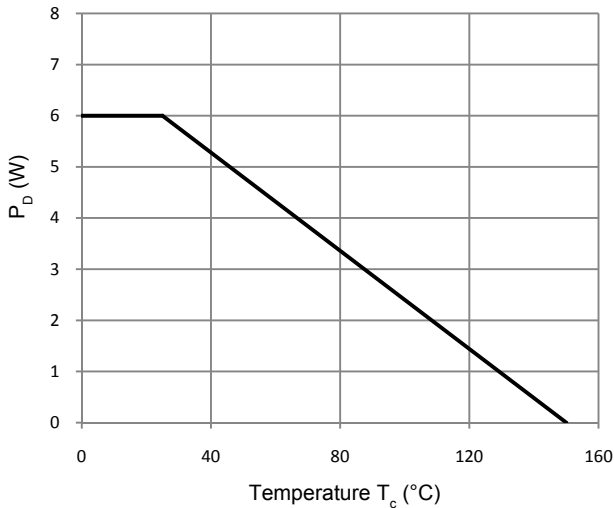

Figure 9. Power Dissipation

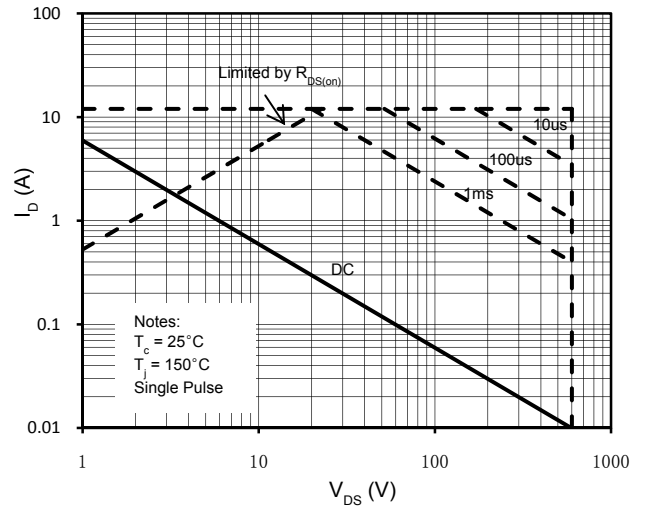

Figure 10. Maximum Safe Operating Area

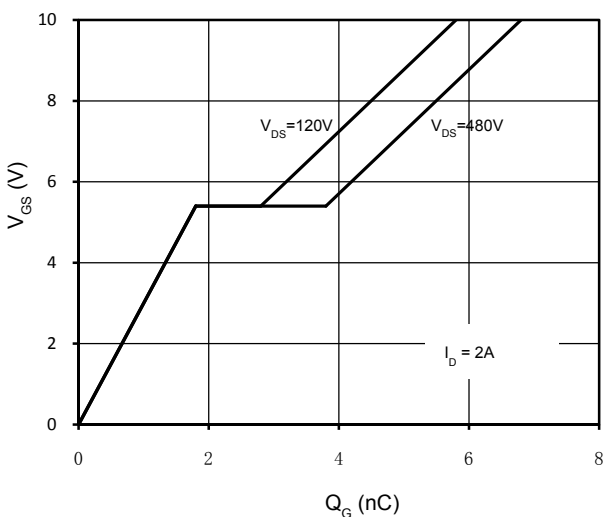

Figure 11. Gate Charge Characteristics

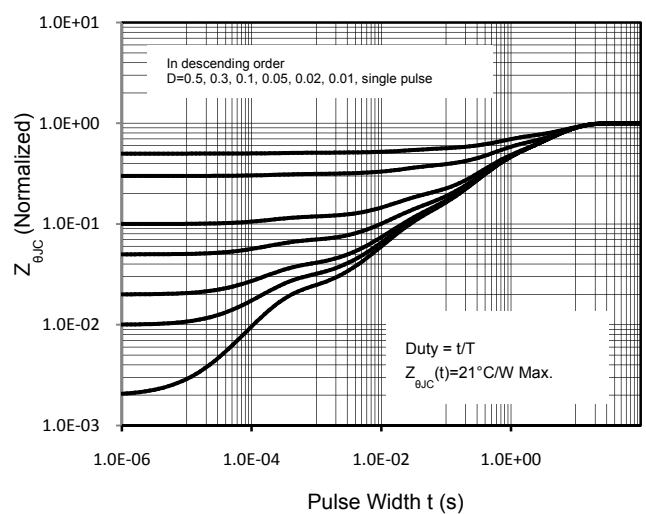
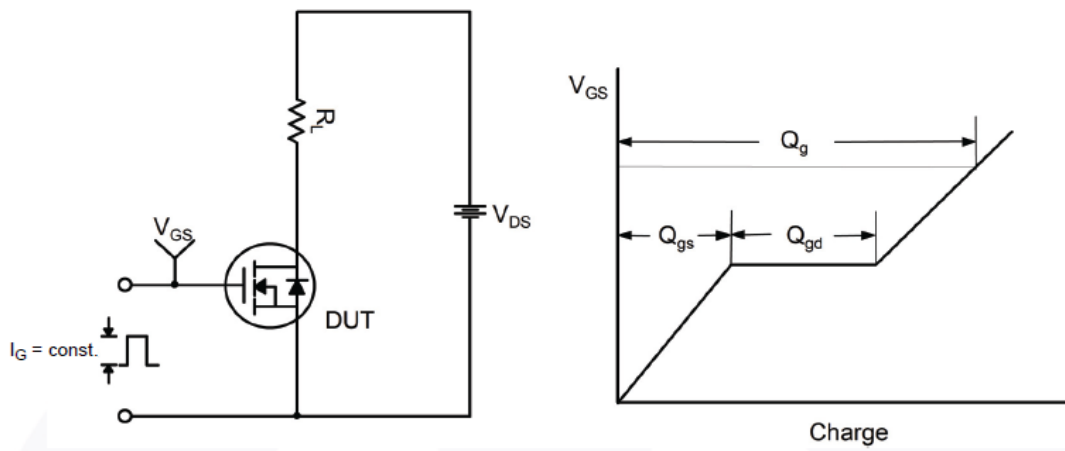

Figure 12. Transient Thermal Response Curve

**Gate Charge Test Circuit & Waveform**



**Switching Test Circuit & Waveforms**



**Unclamped Inductive Switching Test Circuit & Waveforms**

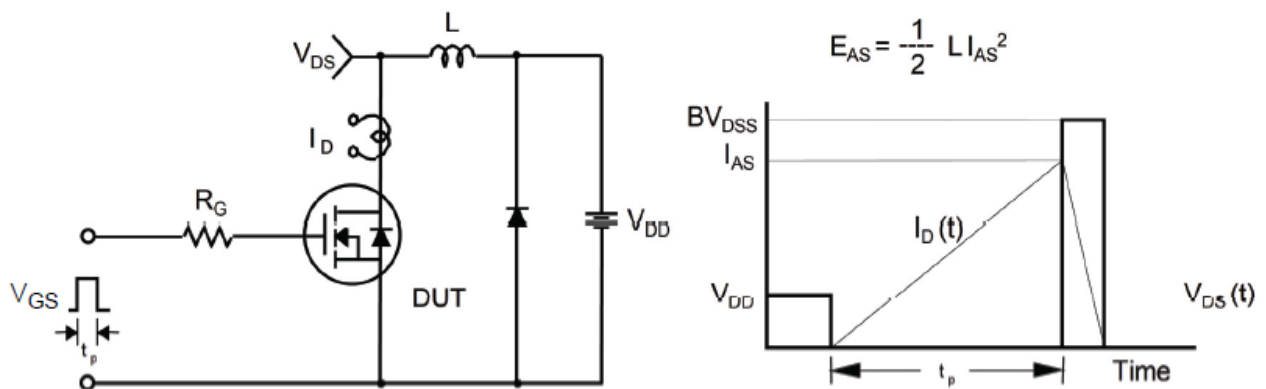

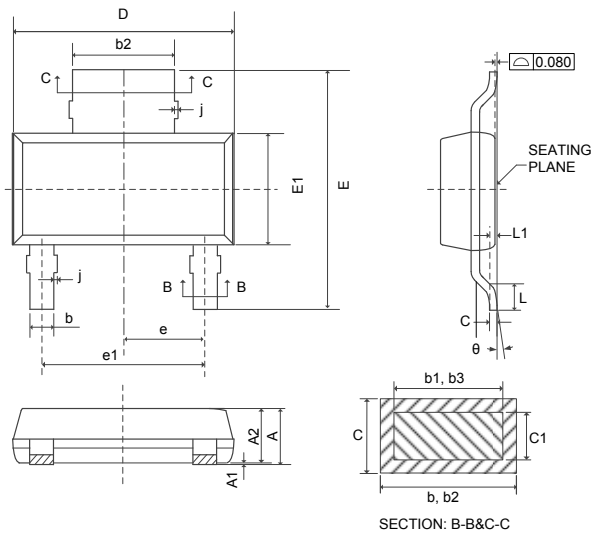
**Mechanical Dimensions for SOT-223-2L**

**COMMON DIMENSIONS**

SYMBOL	mm	
	MIN	MAX
A	-	1.80
A1	0.02	0.10
A2	1.50	1.70
b	0.66	0.84
b1	0.6	0.79
b2	2.90	3.10
b3	2.84	3.05
C	0.23	0.35
C1	0.23	0.33
D	6.30	6.95
E	6.70	7.30
E1	3.30	3.70
e	2.30 BSC	
e1	4.60 BSC	
L	0.81	-
L1	0.25 BSC	
θ	0°	10°
j	-	0.13

## Ordering Information

Part	Package	Marking	Packing method
WMF09N60C2	SOT-223-2L	WMF09N60C2	Tape and Reel

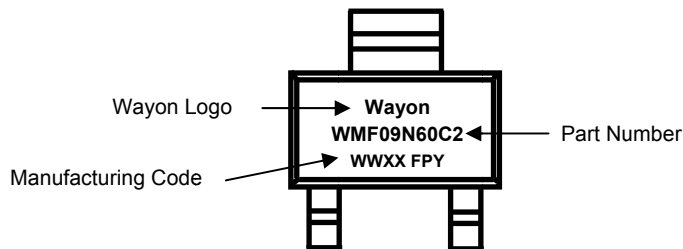
## Marking Information



## Contact Information

### CYG WAYON CIRCUIT PROTECTION CO., LTD.

No.1001, Shiwan(7) Road, Pudong District, Shanghai, P.R.China.201202

Tel: 86-21-50310888 Fax: 86-21-50757680 Email: market@way-on.com

WAYON website: <http://www.way-on.com>

For additional information, please contact your local Sales Representative.

**CYG WAYON** ® is registered trademarks of Wayon Corporation.

## Disclaimer

CYG WAYON reserves the right to make changes without further notice to any Products herein to improve reliability, function, or design. The Products are not designed for use in hostile environments, including, without limitation, aircraft, nuclear power generation, medical appliances, and devices or systems in which malfunction of any Product can reasonably be expected to result in a personal injury. The information given in this document shall in no event be regarded as a guarantee of conditions or characteristics. CYG WAYON does not assume any liability for infringement of patents, copyrights, or other intellectual property rights of third parties by or arising from the use of Products or technical information described in this document.