

100V N-Channel Enhancement Mode Power MOSFET

Description

WMK043N10LG2 uses Wayon's 2nd generation power trench MOSFET technology that has been especially tailored to minimize the on-state resistance and yet maintain superior switching performance. This device is well suited for high efficiency fast switching applications.

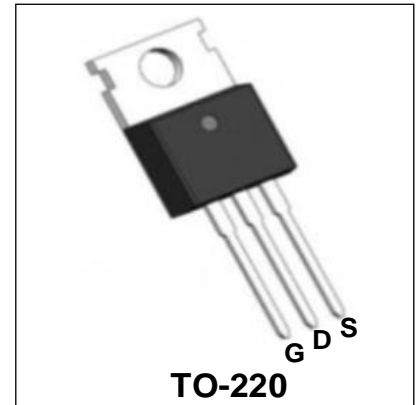

Features

- $V_{DS} = 100V$, $I_D = 166A$ (Silicon Limited)
 $R_{DS(on)} < 4.3m\Omega @ V_{GS} = 10V$
 $R_{DS(on)} < 6m\Omega @ V_{GS} = 4.5V$
- High Speed Power Switching
- Low $R_{DS(ON)}$
- Low Gate Charge
- 100% EAS Guaranteed

Applications

- Hard Switching and High Speed Circuit
- DC/DC Conversion
- Power Tools
- UPS
- SSR

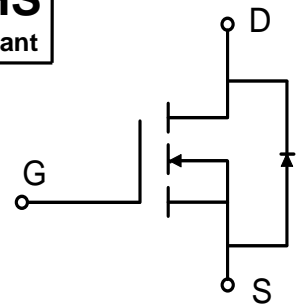

Absolute Maximum Ratings

Parameter	Symbol	Value	Unit
Drain-Source Voltage	V_{DS}	100	V
Gate-Source Voltage	V_{GS}	± 20	V
Continuous Drain Current@10V ¹	I_D	$T_C=25^\circ C$	166
		$T_C=100^\circ C$	118
Pulsed Drain Current ²	I_{DM}	450	A
Single Pulse Avalanche Energy ³	EAS	180	mJ
Avalanche Current	I_{AS}	60	A
Total Power Dissipation ⁴	P_D	$T_C=25^\circ C$	232
Operating Junction and Storage Temperature Range		T_J, T_{STG}	-55 to 175

Thermal Characteristics

Parameter	Symbol	Value	Unit
Thermal Resistance from Junction-to-Ambient ¹	$R_{\theta JA}$	59	$^\circ C/W$
Thermal Resistance from Junction-to-Case ¹	$R_{\theta JC}$	0.65	$^\circ C/W$

Electrical Characteristics $T_c = 25^\circ\text{C}$, unless otherwise noted

Parameter	Symbol	Test Conditions	Min.	Typ.	Max.	Unit	
Static Characteristics							
Drain-Source Breakdown Voltage	$V_{(BR)DSS}$	$V_{GS} = 0V, I_D = 250\mu A$	100	-	-	V	
Gate-body Leakage current	I_{GSS}	$V_{DS} = 0V, V_{GS} = \pm 20V$	-	-	± 100	nA	
Zero Gate Voltage Drain Current	I_{DSS}	$V_{DS} = 100V, V_{GS} = 0V$	$T_J = 25^\circ\text{C}$	-	-	1	μA
			$T_J = 100^\circ\text{C}$	-	-	100	
Gate-Threshold Voltage	$V_{GS(th)}$	$V_{DS} = V_{GS}, I_D = 250\mu A$	1.4	1.9	2.4	V	
Drain-Source On-Resistance ²	$R_{DS(on)}$	$V_{GS} = 10V, I_D = 20A$	-	3.9	4.3	m Ω	
		$V_{GS} = 4.5V, I_D = 20A$	-	4.8	6		
Forward Transconductance	g_{fs}	$V_{DS} = 5V, I_D = 20A$	-	78	-	S	
Dynamic Characteristics							
Input Capacitance	C_{iss}	$V_{DS} = 50V, V_{GS} = 0V,$ $f = 1\text{MHz}$	-	3650	-	pF	
Output Capacitance	C_{oss}		-	875	-		
Reverse Transfer Capacitance	C_{rss}		-	32	-		
Switching Characteristics							
Gate Resistance	R_g	$V_{DS} = 0V, V_{GS} = 0V,$ $f = 1\text{MHz}$	-	1.2	-	Ω	
Total Gate Charge	Q_g	$V_{DD} = 50V, V_{GS} = 10V,$ $I_D = 20A$	-	52	-	nC	
Total Gate Charge	Q_g		-	91	-		
Gate-Source Charge	Q_{gs}		-	7.8	-		
Gate-Drain Charge	Q_{gd}		-	31.5	-		
Turn-On Delay Time	$t_{d(on)}$	$V_{GS} = 10V, V_{DD} = 50V,$ $R = 10\Omega, I_D = 20A$	-	14.5	-	nS	
Rise Time	t_r		-	17	-		
Turn-Off Delay Time	$t_{d(off)}$		-	51	-		
Fall Time	t_f		-	23.5	-		
Drain-Source Body Diode Characteristics							
Diode Forward Voltage ²	V_{SD}	$I_S = 20A, V_{GS} = 0V$	-	-	1.2	V	
Body Diode Reverse Recovery Time	t_{rr}	$V_R = 50V, I_F = 20A,$ $di/dt = 500A/\mu s$	-	44	-	nS	
Body Diode Reverse Recovery Charge	Q_{rr}		-	212	-	nC	

Notes:

- The data tested by surface mounted on a 1 inch² FR-4 board with 2OZ copper.
- The data tested by pulsed , pulse width $\leq 300\mu s$, duty cycle $\leq 2\%$
- The EAS data shows Max. rating . The test condition is $V_{DD} = 25V, V_{GS} = 10V, L = 0.1\text{mH}, I_{AS} = 60A$
- The power dissipation is limited by 150°C junction temperature

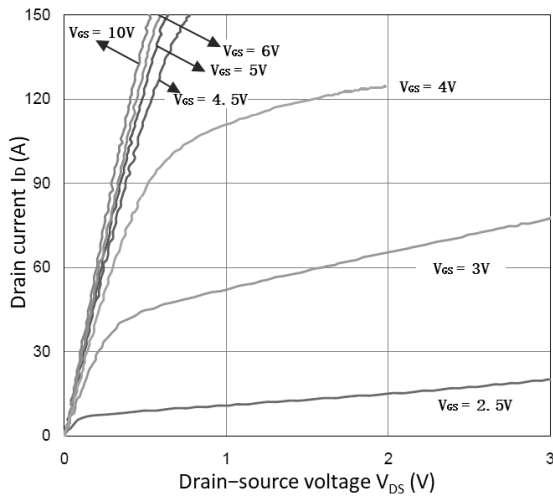

Figure 1. Output Characteristics

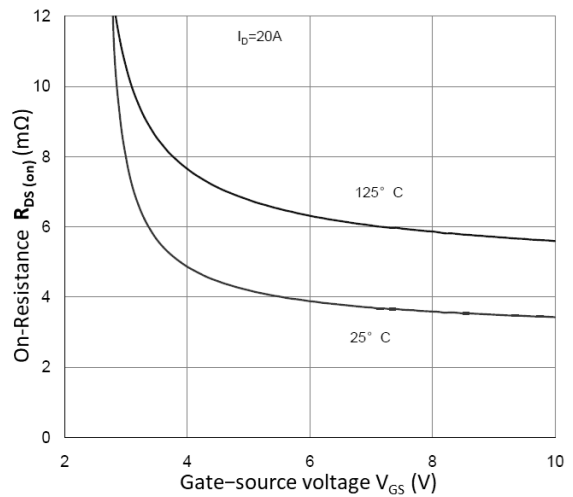

Figure 2. $R_{DS(on)}$ vs. V_{GS}

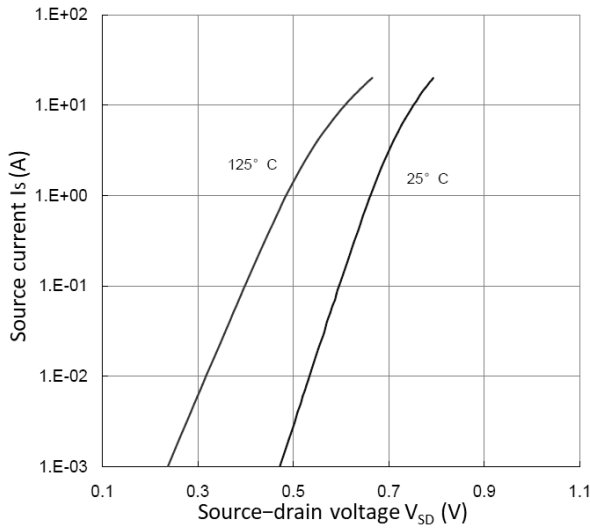

Figure 3. Forward Characteristics of Reverse

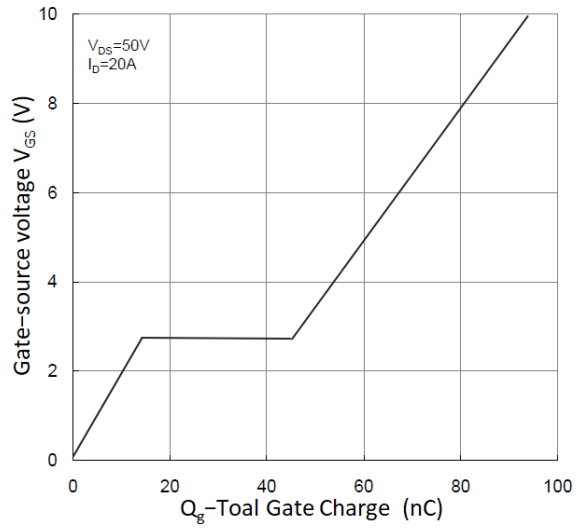

Figure 4. Gate Charge Characteristics

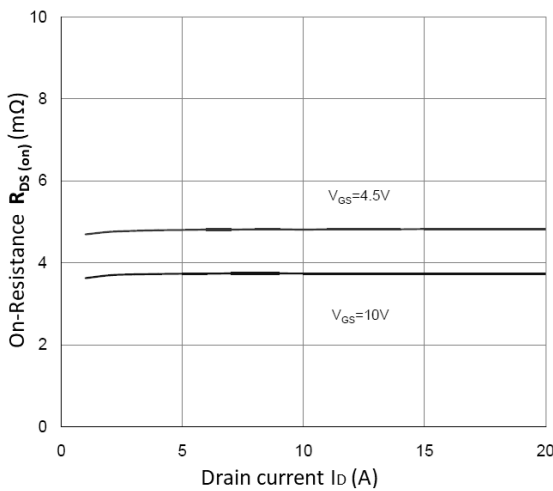

Figure 5. $R_{DS(on)}$ vs. I_D

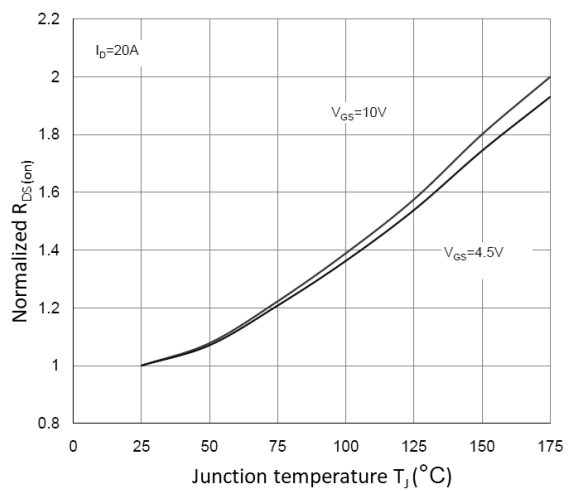

Figure 6. Normalized $R_{DS(on)}$ vs. T_J

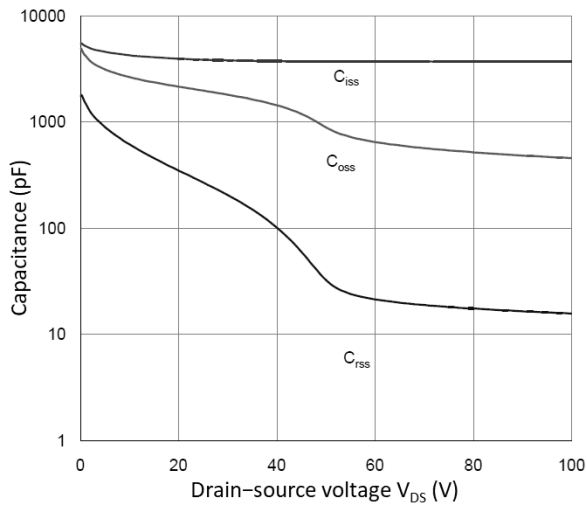

Figure 7. Capacitance Characteristics

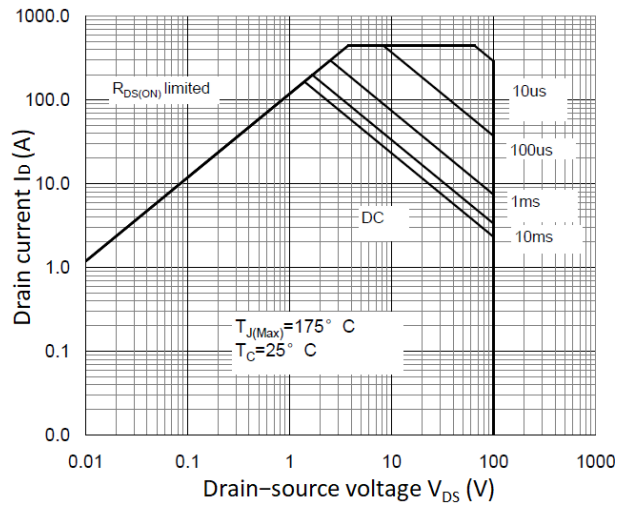

Figure 8. Safe Operating Area

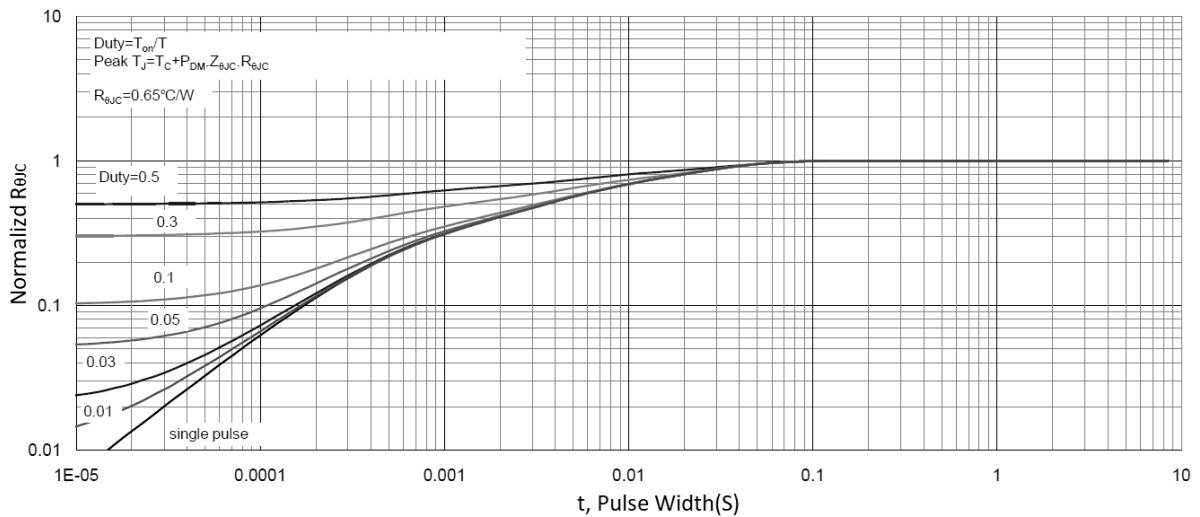

Figure 9. Normalized Maximum Transient Thermal Impedance

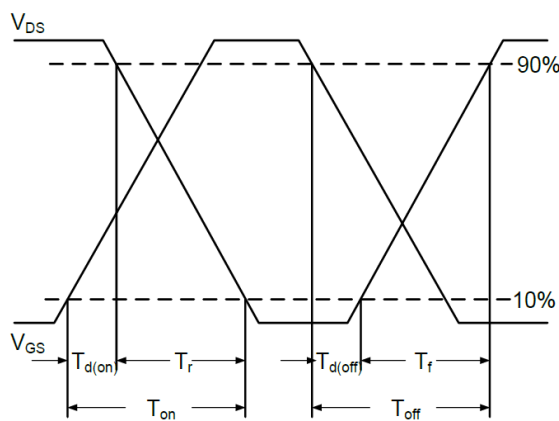

Figure 10. Switching Time Waveform

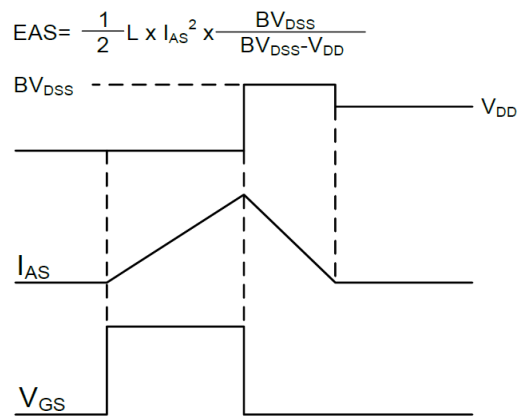
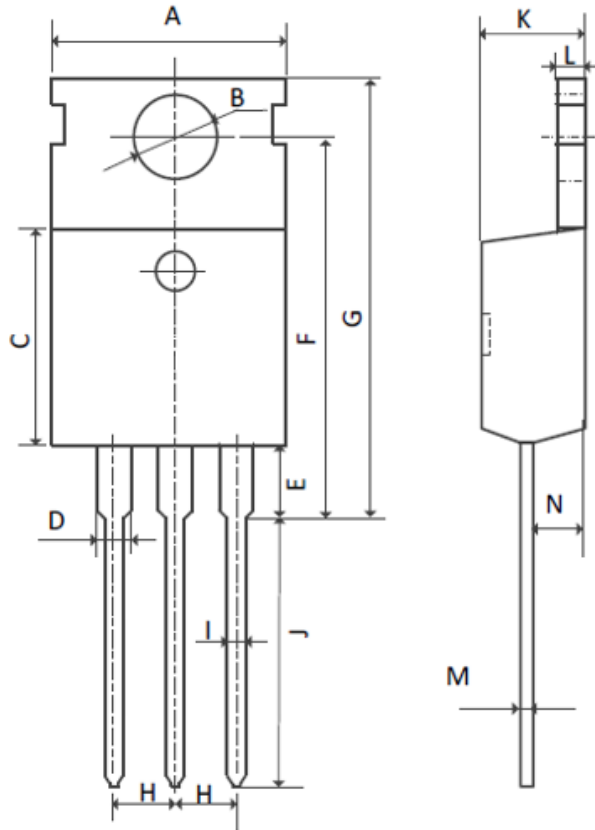

Figure 11. Unclamped Inductive Switching Waveform

Mechanical Dimensions for TO-220



COMMON DIMENSIONS

SYMBOL	MM	
	MIN	MAX
A	9.70	10.30
B	3.40	3.80
C	8.80	9.40
D	1.17	1.47
E	2.60	3.40
F	15.10	16.70
G	19.55MAX	
H	2.54REF	
I	0.70	0.95
J	9.35	11.00
K	4.30	4.77
L	1.20	1.45
M	0.40	0.65
N	2.20	2.60

Ordering Information

Part	Package	Marking	Packing method
WMK043N10LG2	TO-220	WMK043N10LG2	Tube

Marking Information

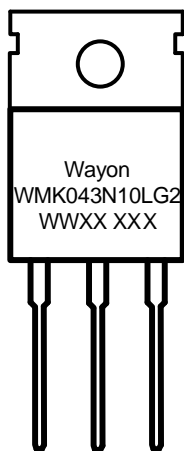

WMK043N10LG2 = Device code

WWXX XXX = Date code

Contact Information

No.1001, Shiwan(7) Road, Pudong District, Shanghai, P.R.China.201207

Tel: 86-21-50310888 Fax: 86-21-50757680 Email: market@way-on.com

WAYON website: <http://www.way-on.com>

For additional information, please contact your local Sales Representative.

 © is registered trademarks of Wayon Corporation.

Disclaimer

WAYON reserves the right to make changes without further notice to any Products herein to improve reliability, function, or design. The Products are not designed for use in hostile environments, including, without limitation, aircraft, nuclear power generation, medical appliances, and devices or systems in which malfunction of any Product can reasonably be expected to result in a personal injury. The information given in this document shall in no event be regarded as a guarantee of conditions or characteristics. WAYON does not assume any liability for infringement of patents, copyrights, or other intellectual property rights of third parties by or arising from the use of Products or technical information described in this document.